



Hydraulic & Offshore Supplies



EO[®] Ermeto Original ***Performance data***





Hydraulic & Offshore Supplies

Pressure rating

Nominal pressure PN

The Nominal pressure PN is a figure relating to the pressure rating of a fluid component for continuous dynamic applications. It is rounded to correspond to internationally standardised ratings. Logical series of fittings are grouped together, with the nominal pressure of the group being that of the "lowest common denominator" within the group.

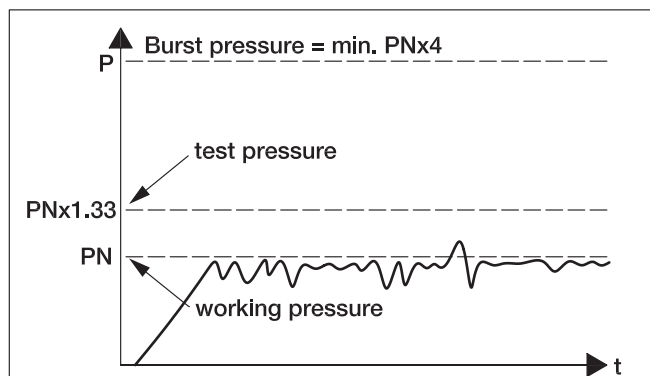

Internationally, these nominal pressures are recognised and serve to match common sizes of components together. Parker tube fittings meet or exceed common standardised pressure ratings.

To prove the long term dynamic load resistance, components are tested under pressure impulse conditions of $PN \times 1.33$, at 1Hz for 1 million cycles. Static test burst pressures are at least 4 times the PN value.

Exception: for ball valves the static test burst pressures are at least 1.5 times the PN value according to DIN 3230 T5 and ISO 5108.

Conversion chart

Bar	Mpa	PSI
100	10.0	1450
160	16.0	2321
210	21.0	3045
315	31.5	4569
350	35.0	5075
400	40.0	5801

Pressure reductions and temperatures

Required pressure reductions (dependant on the material) with reference to the catalogue pressures for higher temperatures. Both metal fitting material and elastomeric sealing compound have to be selected according to the temperature range of the system.

Attention: Fluid Compatibility see page C5.

Fittings material	Pressure reduction of permissible operating temperatures TB in °C														
	-60	-50	-40	-35	-25	+20	+50	+100	+120	+150	+175	+200	+250	+300	+400
Steel, fittings						0%				11%	19%		28%		
Steel, tubes						0%					19%		27%		
Stainless steel, fittings						0%				11%		20%		30%	
Stainless steel, tubes						0%		5.5%	11.5%		21.5%		29%		34%
Brass, fittings ¹⁾															
Sealing material NBR (e.g. Perbunan)															
Sealing material FKM															
Sealing material EPDM ²⁾															

- Permissible operating temperature
- Ambient temperature of hydraulic and pneumatic applications
- Temperature not permissible

Perbunan = registered trademark of Bayer
¹⁾ 35% (if not extra shown in PN-Colum "MS" for Brass)

²⁾ EPDM is not compatible with oil (not normally held in Stock)

Calculation example:

PN fitting 16S/71 = 400 bar
 Temperature = 200°C
 Material = Stainless steel
 Pressure reduction fittings = 20%
 Pressure reduction tubes = 21,5%
 PN tube 16 x 2.5/71, DIN 2413 III = 362 bar

Formula:

$$PN_{\text{fitting } 200^\circ\text{C}} = \frac{400 \text{ bar}}{100\%} \times (100\% - 20\%) = 320 \text{ bar}$$

$$PN_{\text{tube } 200^\circ\text{C}} = \frac{362 \text{ bar}}{100\%} \times (100\% - 21,5\%) = 284 \text{ bar}$$



Hydraulic & Offshore Supplies

Materials

Fittings	Raw material	Material				Fitting type										
						EO				O-Lok®			Triple-Lok®			
		Designation ²⁾	Material No.	Standard	US Designation ²⁾	Bodies	Nuts	Ferrules	Weld fittings	Bodies	Nuts	Sleeves	Bodies	Nuts	Sleeves	
Steel	Barstock	11SMnPb30	1.0718	DIN EN 10277-3	SAE 12L14	X				X		X	X		X	
	Free cutting steel	11SMn30	1.0715	DIN EN 10277-3	SAE 1213	X										
		46S20	1.0727	DIN EN 10277-3	SAE 1146		X									
	Forgings	15S10	1.0710	DIN 1651		X										
	Free cutting steel	11SMn30 modified	1.0715	DIN EN 10087	SAE 1213 modified					X				X		
		36SMn14	1.0764	DIN EN 10087			X									
		C45 modified	1.0503	DIN EN 10083	SAE 1045 modified			X			X				X	
	Extrusion steel	C10C	1.0214	DIN EN 10263	SAE C1010			X			X	X			X	X
	Weldable steel	C15	1.0401	DIN 10277-3						X						
	Other	Steel at the manufacturers discretion special heat treated							X							X
Stainless steel	Barstock	X6CrNiMoTi 17-12-2	1.4571	DIN EN 10088	ANSI 316TI	X	X		X							
		X2CrNiMo 17-13-2	1.4404	DIN EN 10088	ANSI 316L					X	X	X	X	X	X	
	Forgings	X6CrNiMo Ti17-12-2	1.4571	DIN EN 10088	ANSI 316TI	X	X		X							
		X5CrNiMo 17-12-2	1.4401	DIN EN 10088	ANSI 316					X	X	X	X	X	X	
	Other	Stainless steel at the manufacturers discretion special heat treated							X							
Brass	Barstock	CuZn35Ni2	2.0540	DIN 17660		X	X	X								
				ASTM B16/B453	CA360/345					X	X	X	X	X	X	
	Forgings	CuZn35Ni2	2.0540	DIN 17660			X									
ASTM B124				CA377					X			X				

1) Non standard fitting types like e.g. banjo fittings, rotary fittings, adjustable fittings with locknut and flanges might be made from different materials.

2) Equivalent materials may be used

Forging: 11 SMn 30+Bi (similar to 1.0715/DIN EN 10087)

Straight: 11 SMn Pb30 (1.0718/DIN EN 102773)

Sealings	NBR	e.g. N552-90, Perbunan (registered trademark of Bayer)
	FKM	e.g. V894-90
	EPDM	e.g. E540-80
	PTFE	e.g. Teflon® (registered trademark of DuPont)
	POM	e.g. Delrin (registered trademark of DuPont)



Hydraulic & Offshore Supplies

Surface treatment

Parker tube fittings from steel are delivered worldwide with a high quality surface protection. New Generation fittings are delivered with even higher quality surface protection: galvanic zinc plated and bright passivated with special sealer (suffix CF).

Why zinc plated?

The requirements for corrosion resistance of tube fittings have been increasing in the past few years. Increasingly tube systems are not painted. Higher demands are requested also for an aesthetic point of view.

The traditional black-grey surface “phosphated and oiled” (Znphr5f – DIN 50942) used for tube connections in the past does not longer meet these demands. An galvanized deposit zinc layer offers the following advantages: The corrosion resistance increases significantly due to a plating of min. 8 µ and additional sealing by chromating process. In case of scratches or nicks – which are unavoidable during assembly – zinc develops a cathodical protection of the steel fitting body against localised corrosion and abrasion.

The corrosion resistance of the CF surface is 400 % above zinc plated surfaces to meet highest requirements. The CF surface is also Cr(VI)-free to avoid

any contamination in the manufacturing process and meets future regulations e.g. European “End of Life Vehicles” directive.

The silver bright colour due to the chromating or passivation process offers an attractive appearance.

All major TFDE manufacturing locations are equipped with their own modern galvanic plants. The process control is specially orientated to the tube fitting product.

The users of Parker fittings benefit from:

- homogeneous thickness of plating (average 13 µm), measured on outside contour for good screwable threads
- high quality above-average concerning avoidance of nicks
- very good corrosion resistance

Continuous corrosion tests like salt spray tests according to ISO 9227/5% NaCl show an average resistance of 500 hr in contrast to white rust and 700 hr in contrast to red rust for CF surfaces.

Particular fitting series or fitting components and valves are delivered with other or modified surfaces for functional reasons or for better differentiation.

Material	Fitting system	Fitting type	Surface protection/Surface						
			CF Zinc plated bright passivated	CF + Glide coating	A3K Zinc plated bright passivated	Znphr5f black phosphated	Plain no coating	Plain + Glide coating	Plain + Inside silver
New Generation steel	EO2-Plus	Fitting bodies	X						
		Functional nuts		X					
	EO-Plus	Fitting body	X						
		Nuts		X					
		Progressive stop rings			X				
EO2-FORM	Bodies and nuts from EO-plus are used								
Steel	EO-2	Fitting bodies							
		Functional nuts							
	EO	Fitting bodies	X						
		Nuts	X						
		Progressive stop rings			X				
		Weld fittings				X			
	EO2-FORM	Bodies and nuts from EO are used							
	O-Lok®	Fitting bodies	X						
		Nuts	X						
		Parflange® sleeves	X						
		Brazing sleeves					X		
	Triple-Lok®	Fitting bodies	X						
		Nuts	X						
Sleeves		X							



Hydraulic & Offshore Supplies



Material	Fitting system	Fitting type	Surface protection/Surface							
			CF Zinc plated bright passivated	CF + Glide coating	A3K Zinc plated bright passivated	Znphr5f black phosphated	Plain no coating	Plain + Glide coating	Plain + Inside silver	
Stainless steel	EO-2	Fitting bodies					X			
		Functional nuts up to 12-L/10-S						X		
		Functional nuts from 15-L/12-S							X	
	EO	Fitting bodies					X			
		Nuts up to 12-L/10-S						X		
		Nuts from 15-L/12-S							X	
		Progressive rings				X				
	EO2-FORM	Bodies and nuts from EO are used								
	O-Lok®	Fitting bodies					X			
		Nuts					X			
		Sleeves					X			
	Triple-Lok®	Fitting bodies					X			
		Nuts					X			
Sleeves						X				
Brass	All systems	Fitting bodies					X			
		Nuts					X			
		Sleeves & ferrules					X			

A3K according to DIN EN ISO 4042 / Znphr5f according to DIN EN ISO 3892 and DIN 50942

Fluid compatibility

Both metal fitting material and elastomeric seal compound have to be selected according to the fluid used. Standard recommendations for static seals based on experience and sealing compound manufacturers specification. For use of sealing compounds that are used for dynamic seals like rotary fittings or non-return-valves, see note at end of table.

Fluid	Fitting material			Sealing material		
	Steel	Stainless steel	Brass	NBR	FKM	EPDM
Acetone	2	1	1	3	3	1
Acetylene	2	1	3	3	3	2
Air (oil free)	1	1	1	1	1	1
Ammonia liquid	2	1	3	2	3	1
Ammonia gas, cold	1	1	3	1	3	1
Animal oils (Lard oil)	2	2	2	1	1	2
Aral, Vitam BAF	1	1	X	1	1	3
Argon	1	1	1	1	1	1
Aromatic fuel – 50%	X	X	X	2	1	3
Aromatic solvents	X	2	X	2	1	X
Asphalt	3	1	3	2	1	3
ASTM-Oil, no.1	1	1	1	1	1	3
ASTM-Oil, no.2	1	1	1	1	1	3
ASTM-Oil, no.3	1	1	1	1	1	3
ASTM-Oil, no.4	1	1	1	2	1	3
ATF oil	1	1	1	1	1	3
Automotive brake fluid	1	1	1	3	3	1
Benzene	1	1	1	3	1	3
Brine (sodium chloride)	X	1	X	1	1	1
Butane	1	1	3	1	1	3
Carbon bisulphide	1	1	3	3	1	X
Carbon dioxide	1	1	1	1	2	1
Carbon oxide	1	1	1	1	1	1
Castrol, Biotec HVX	1	1	X	1	1	3
Chlorine (dry)	3	1	3	3	1	X



Hydraulic & Offshore Supplies

Fluid	Fitting material			Sealing material		
	Steel	Stainless steel	Brass	NBR	FKM	EPDM
Compressed air	1	1	1	1	1	1
Crude oil	2	1	3	2	1	3
Cutting oil	1	1	X	1	3	1
DEA, Econa E22	1	1	X	1	X	3
DEA, Econa E46	1	1	X	1	X	3
Diesel fuel	1	1	1	1	1	3
ECOOL	1	1	X	1	1	X
ESSO, Univis 13	1	1	X	1	1	3
ESSO, Univis 26	1	1	X	1	1	3
ESSO, Univis 32	1	1	X	1	1	3
ESSO, Univis 46	1	1	X	1	1	3
Ethanol (Ethylalkohol)	1	1	1	1	3	1
Ether	1	1	1	3	3	2
FINA, Biohydran RS 38	1	1	X	1	1	3
Flue gas	3	1	3	3	2	X
FRAGOL, Hydrolub 125	1	1	X	1	X	3
Freon 11	X	X	1	2	2	3
Freon 12	1	3	1	2	1	3
Freon 22	3	1	1	3	2	3
Fuel oil	1	1	1	1	1	3
Gasoline	2	1	1	2	1	3
Gas, liquid propane (LPG)	1	1	1	1	1	3
Gas, natural	2	1	2	1	1	3
Glycerine	2	1	2	1	1	1
Glycol (Ethylenglykol)	1	1	2	1	1	1
Heating fuel oil	1	1	1	1	1	3
Helium	1	1	1	1	1	1
Houghton Safe 1120	1	1	X	3	1	1
Houghton Safe 620	1	1	X	1	2	1
Hydraulic oil – Petroleum base	1	1	1	1	1	3
Hydraulic oil – Water base	1	1	X	2	1	3
Hydrochloric acid	3	2	3	3	1	2
Hydrogen	3	1	X	3	3	3
Hydrogen peroxide	3	1	3	3	1	2
Hydrolube	1	1	1	1	1	1
Jet fuel	1	1	1	1	1	3
Jod	3	1	3	2	1	2
Kerosene	1	1	1	1	1	3
Lubricating oil SAE 10,20,30,40,50	1	1	1	1	1	3
Methane	1	1	1	1	1	3
Methanol	1	1	1	1	3	1
MIL-F-8192 (JP-9)	1	1	1	3	1	3
MIL-H-5606	1	1	1	1	1	3
MIL-H-6083	1	1	1	1	1	3
MIL-H-7083	1	1	1	1	2	1
MIL-H-8446 (MLO-8515)	1	1	2	2	1	3
MIL-L-2104 & 2104B	1	1	1	1	1	3
MIL-L-7808	2	1	3	2	1	3
Mineral oil	1	1	1	1	1	3
Natural gas	1	1	2	1	1	3
Natural gas , untreated	3	1	3	3	3	3
Natural mineral oil	1	1	3	2	1	3
Neon	3	1	1	1	1	1
Nitric acid	3	1	3	3	2	3
Nitrogen	1	1	1	1	1	1
Oil	1	1	3	1	1	3
Oxygen (gas, cold)	3	1	2	3	3	3
Ozone	1	1	3	3	1	1



Hydraulic & Offshore Supplies



Fluid	Fitting material			Sealing material		
	Steel	Stainless steel	Brass	NBR	FKM	EPDM
Petrolatum	1	1	1	1	1	3
Petroleum oil	1	1	1	1	1	3
Phosphoric acid	3	3	1	3	1	2
Plantohyd 32 S	1	1	X	1	X	3
Plantohyd 40 N	1	1	X	1	1	3
Propane	1	1	1	1	1	3
R134A	1	1	1	3	3	1
Sea water	3	2	3	1	1	1
SHELL, Naturelle HF-E-46	1	1	X	1	1	3
SHELL, Tellus Oil DO 32	1	1	X	1	1	3
Silicone oil	1	1	X	1	1	1
Skydrol 500	1	1	3	3	3	1
Skydrol 7000	1	1	3	3	2	1
Soap solutions	3	1	3	1	1	1
Steam	2	1	2	3	3	1
Stoddard solvent	1	1	2	1	1	3
Sulphur dioxide	3	1	3	3	3	1
Sulphuric acid	3	2	3	3	1	3
Toluol	1	1	1	3	2	3
Transmission fluid	1	1	1	1	1	3
Trichlorethane	2	1	X	3	1	3
Turpentine	2	1	3	1	1	3
Water	2	1	1 ¹⁾	1	2	1
Xylol	1	1	1	3	1	3

Applicability: 1 = satisfactory
 2 = fair
 3 = not recommended
 X = insufficient data

NBR = e.g. Perbunan (registered trademark of Bayer)
 FKM

¹⁾ Brass is resistant against crack under normal circumstances. If overloaded (e.g. by overassembly) the resistance especially against ammoniac and nitric derivatives can be negatively influenced. This might cause the defect of the connection.

This fluid compatibility chart is only applicable on so called "static seals", such as O-rings and profile sealing rings (e.g. ED-seal, DOZ-seal) in tube fitting and flange systems.

For fluid compatibility data of valves, rotary fittings or other multi-function components please review the relevant product pages.



Hydraulic & Offshore Supplies

Biodegradable oils

Due to environmental concerns and new legislation biodegradable oils are rapidly gaining importance for both mobile and stationary applications. Optimistic estimations say that the market share of biodegradable oils will reach 50% by 2005 with some 80% being synthetic ester types (HEES). The usage of non-inflammable fluids will remain limited to special applications like mining, steel mills and heavy machines.

Media

Biodegradable oils can be classified into 3 categories:

HEPG (Glycol based fluids)

- + Wide temperature range (-45°C ... 100°C)
- + Very stable against ageing
- + NBR and FKM seals are compatible
- + Moderate viscosity change with temperature
- + Water soluble
- Not mixable with mineral oils or HEES, HETG types
- Careful flushing recommended when changing from mineral oil
- Paints can be dissolved
- Care required with material compatibility (eg. do not use any zinc containing materials)
- Density > 1,100 kg/m³ possible design changes
- Price?

HETG (Vegetable-based fluids)

- + Mixable with mineral oils
- + Normal sealing material are compatible (e.g. NBR or FKM)
- + Good lubricating properties
- + Paint resistant to fluid
- + Viscosity changes with temperature are moderate
- Limited temperature range (-25° C to +70°C)
- Max. temperature not to be exceeded
- Limited lifetime
- UV and ozone sensitive
- Beware of water take-up (cracking?)
- Price?

HEES (Synthetic ester based fluids)

- + Wide temperature range (-30° C ... +90° C or over 100° C with some variants)
- + Good lifetime
- + Mixable with mineral oils
- + Normal sealing materials compatible (FKM and NBR recommended)
- + Machine paints resistant to fluid
- + Viscosity changes with temperature are moderate
- + Good lubricating properties
- Danger of hydrolysis with water take-up (filters, dryer, occlusion)
- Price?

Compatibility

Generally, TFDE steel fittings with standard NBR seals are suitable for most applications.

	-20° C ... 80°C	80°C ... 120°C
HEPG Polyalkylenglycol	NBR FKM	Not suitable for Oil
HETG Vegetable Oil	NBR FKM	- FKM
HEES Synthetic ester	NBR FKM	- FKM

Suitable sealing compounds

Experience shows that media compatibility is not a critical issue for static seals used on tube fittings. In doubt please contact TFDE application engineering.

Pragmatic approach

If there is doubt about switching over to softseal fitting systems (ISO6149/Eolastic/O-Lok®/EO-2), it might be a good idea to have a close look on the existing hydraulic system. If NBR seals perform well on hoses, cylinders, valves or filters there is nothing to worry about standard TFDE fittings. Usually the design engineers know when special seal compounds like FKM have to be used.



Flow characteristics

Hydraulic systems are in most cases only rated with a flow velocity defined on the basis of experience. The pressure losses in lines are not taken into account, or measured later on when testing the system. As the pressure losses increase proportionally greater than the flow resistance, it is important to achieve the best rating of the system, that they are already taken into account when planning the tube connections. Calculation is not as difficult as it is often thought, and this chapter is intended to provide a guideline. Besides, it provides information on how excessive pressure losses can be avoided, because pressure losses result in losses in performance and excessive heat. Noise occurs, and possibly cavitation in suction lines.

Medium

All indication given with regard to flow restrictions and to flow properties refer exclusively to liquids. For gaseous media, the variable density of the gas must additionally be taken into account.

Units

$$c = \text{Flow velocity} \left[\frac{\text{m}}{\text{s}} \right]$$

$$d = \text{Pipe inside diameter [m]}$$

$$L = \text{Pipe length [m]}$$

$$p = \text{Pressure [Pa], 1 bar} = 100000 \text{ Pa}$$

$$\dot{V} = \text{Flow rate} \left[\frac{\text{m}^3}{\text{s}} \right], 1 \frac{\text{m}^3}{\text{s}} = 60000 \frac{\text{l}}{\text{min}}$$

$$\lambda = \text{Pipe friction factor}$$

$$v(T) = \text{Kinematic viscosity of the medium depending on temperature} \left[\frac{\text{m}^2}{\text{s}} \right]$$

$$\rho(T) = \text{Density of the medium depending on temperature} \left[\frac{\text{kg}}{\text{m}^3} \right]$$

$$\zeta = \text{Individual pressure loss coefficient}$$

Only base units have been used. This has the advantage that the formula do not contain correction factors and there is no danger of confusion, e.g. that values are used with the wrong unit. In case values are given in other units – the flow rate is e.g. often given in l/min – it is advisable to convert them into the base units before starting calculation.

Pressure losses in pipe lines

To calculate pressure losses in pipe lines, it must first be determined whether there is a laminar or a turbulent flow. Laminar flow is homogenous and without turbulence. In case of turbulent flow, the losses increase much more quickly.

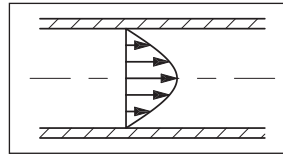

Flow profile with laminar flow

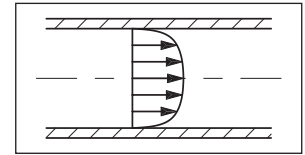

Flow profile with turbulent flow

The kind of flow is defined by the Reynolds' number. With a Reynolds' number of more than 2320, the flow changes to turbulent. The Reynold number is calculated according to the formula:

$$Re = \frac{c \cdot d}{v(T)}$$

The Reynolds' number is a non-dimensional number. The critical fluid velocity at which the flow regime can change, is thus calculated from:

$$c_{cr} = 2320 \cdot \frac{v(T)}{d} \left[\frac{\text{m}}{\text{s}} \right]$$

With a given flow rate, the fluid velocity can be calculated according to the formula:

$$c = \frac{\dot{V} \cdot 4}{d^2 \cdot \pi} \left[\frac{\text{m}}{\text{s}} \right]$$

Subsequently, the pipe friction factor λ can be calculated. The pipe friction factor λ is a function of the Reynold number and also depends on the roughness of the pipe. As hydraulically smooth pipes can generally be assumed in hydraulic applications, the pipe friction factor λ is calculated according to the following formula:

$$\text{laminar flow, (Re} < 2320\text{): } \lambda = \frac{64}{Re}$$

$$\text{turbulent flow, (Re} < 2320\text{): } \lambda = \frac{0.3164}{\sqrt[4]{Re}}$$

Finally, if all factors are known, the pressure loss in a certain pipe line can be calculated according to the formula:

$$\Delta p = \lambda \cdot \frac{L}{d} \cdot \frac{\rho(T) \cdot c^2}{2} \text{ [Pa]}$$

Calculation of individual losses

A hydraulic system does not only incorporate pipes, but also valves, fittings, pipe bends etc. that cause flow losses. These individual losses are often much higher than the pipe losses and are calculated according to the following formula:

$$\Delta p = \zeta \cdot \rho(T) \cdot \frac{c^2}{2} \text{ [Pa]}$$



Hydraulic & Offshore Supplies

The pressure loss coefficient ζ relates to an individual hydraulic component. It covers circulation, impact and separation losses of the flow in a component. In most cases, valve or fitting manufacturers state the pressure loss coefficient of their products. The ζ values are not completely constant. The values increase in the case of very low fluid velocities. The following diagram shows the typical course of the ζ values for a component, depending on the fluid velocity, as it has been determined through a series of tests in the laboratory of the Parker Hannifin GmbH & Co. KG.

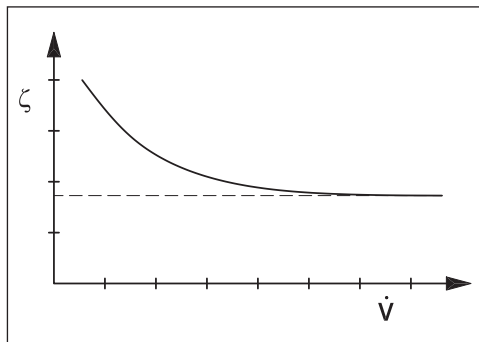

As only the flow resistances at nominal power, i.e. at higher fluid velocities, are generally calculated to rate a hydraulic plant, they may therefore be slight variations for individual sizes.

Straight fittings, e.g. G, GE, EGE, HMTX, F...MTX, F6...MX, HMLO, F...MLO, F6...MLO, ...

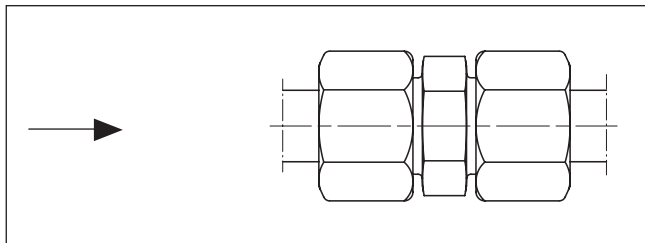

If there is a step change between the bore of the fitting and the inside diameter of the pipe, the conditions applicable to reducers (see below) are valid.

In a normal case, however, the pressure loss is very small, so that it cannot be measured by normal methods. Literature gives a pressure loss coefficient of 0.01 to 0.05.

Reducers, e.g. RED, GR, TRMTX, TRMLO, ...

With reducers, distinction must be made between a cross section increase or reduction. The fluid velocity taken as a basis to calculate the pressure loss is always the velocity at the outlet of the flow.

Extension of the cross section:

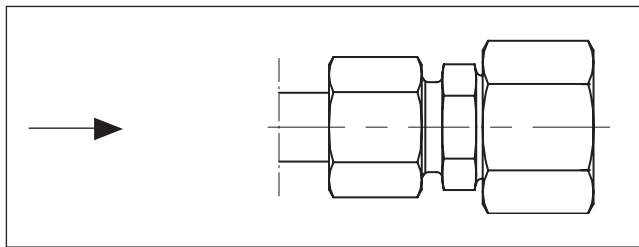

$$\zeta = \left(\frac{A_2}{A_1} - 1 \right)^2$$

With A_1 ... Inlet cross section area
 A_2 ... Outlet cross section area

The formula stated is valid for a transition angle $> 60^\circ$, and thus also for EO fittings.

It is difficult to state a figure, as the program of reducers is extensive.

With an RED style of fitting, the pressure loss coefficient ζ can vary between 1.5 and 5000, always referred to the flow velocity at the outlet.

Reduction of the cross section:

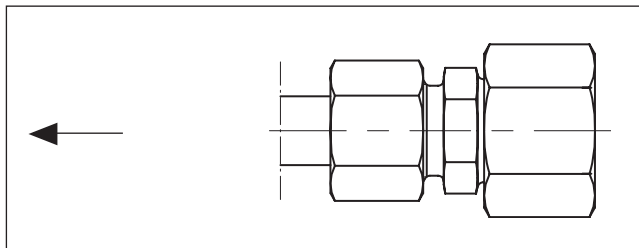

A_2/A_1	0.80	0.60	0.40	0.20
ζ	0.15	0.25	0.35	0.42

Elbow connectors, e.g. W, EW, EMTX, C...MTX, EMLO, C...MLO, ...

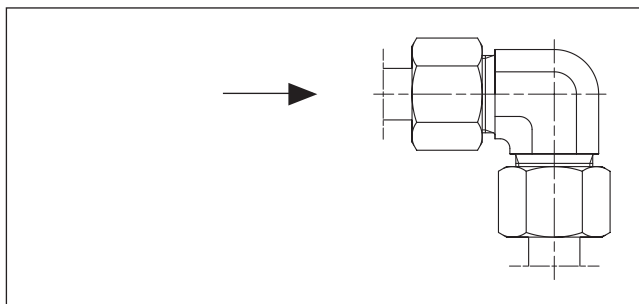

Type	Pressure loss coefficient ζ
W, EMTX, EMLO	1
EW, C...MTX, C...MLO	1



Hydraulic & Offshore Supplies



Tube bends

With pipe bends, the pressure loss coefficient results from the ratio of bend radius to inside diameter (R/d).

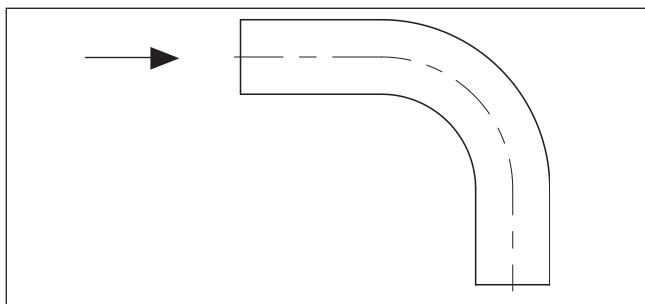

Bend radius/Inside diameter	Pressure loss coefficient ζ
2	0.21
4	0.14
6 and more	0.11

Banjo fittings

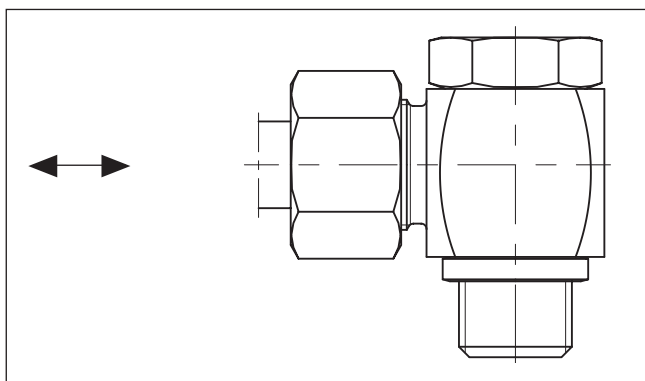

Type	Pressure loss coefficient ζ
WH	3 ... 6
SWVE	6 ... 9
DSVW	approx. 4

With WH and SWVE, the pressure loss depends on the position of the banjo bolt cross hole drilling to the tube connection aperture. The pressure loss coefficient is therefore given as a range.

Manifolds and Tee/Cross fittings

The pressure loss coefficient depends on whether the medium is divided or flows together, and in what ratio the medium is divided.

Index a: The medium flows straight through the manifold.
 Index b: The medium flows through the cross branch of the manifold.

Flow division (to/from T branch)	Pressure loss coefficient ζ in case of pipe branching		Pressure loss coefficient ζ in case of pipe junction	
	\dot{V}_b / \dot{V}	ζ_a	ζ_b	ζ_a
0.6	0.07	0.95	0.40	0.47
0.8	0.20	1.10	0.50	0.73
1.0	0.35	1.30	0.60	0.92

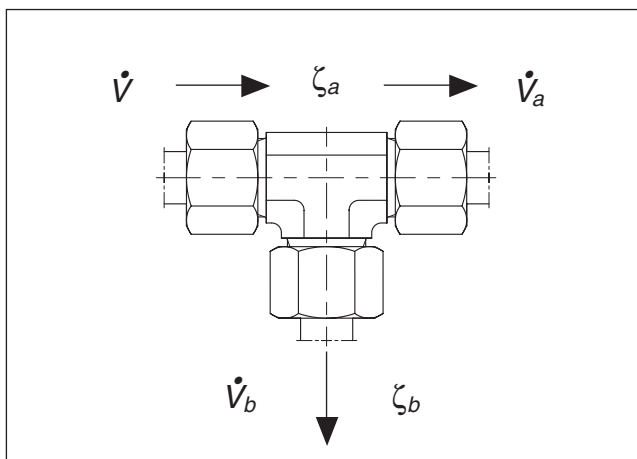

Pipe branching

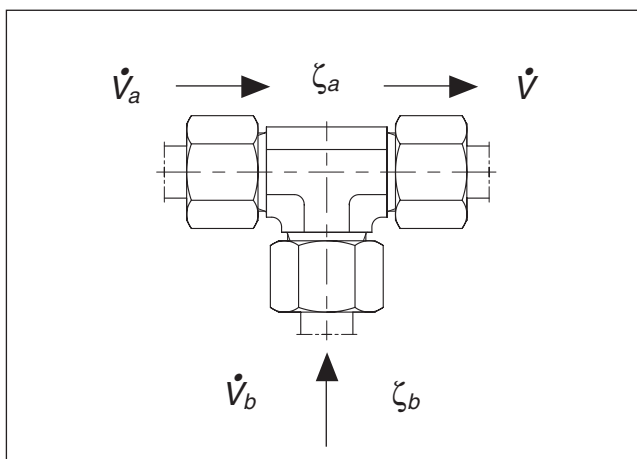

Pipe junction



Hydraulic & Offshore Supplies

Valves, e.g. RHD, DV, VDHA, ...

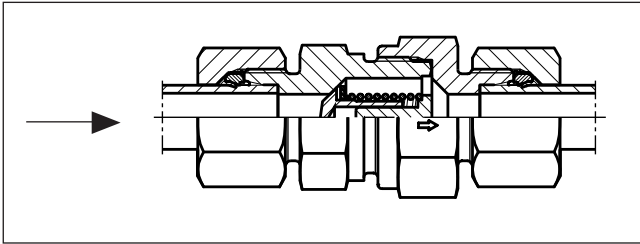

Type	Pressure loss coefficient ζ
RH ...	5.0
DV	5.5
LD	4.0
VDHA	5.0
VDHB	5.5

The pressure loss coefficient stated is always valid for the fully opened valve.

Calculation of the pressure loss Δp – example a WH 16-SR/CF (Banjo fitting).

The pressure loss Δp is calculated according to the following formula:

$$\Delta p = \zeta \cdot \rho(T) \cdot \frac{c^2}{2} \text{ [Pa]}$$

To calculate pressure loss at a flow rate of 20 l/min is to be calculated.

The following values are known:

Pipe inside diameter $d = 12 \text{ mm} = 0.012 \text{ m}$

Density of the medium $\rho = 869; 4 \text{ kg/m}^3$

(Oil manufacturer's data sheet)

Pressure loss coefficient $\zeta = 4.5$

(Average value for WH fittings)

$$\text{Flow rate } \dot{V} = \left[\frac{20}{60000} \right] = 0.000333 \left[\frac{\text{m}^3}{\text{s}} \right]$$

$$\text{Fluid velocity } c = \frac{\dot{V} \cdot 4}{d_2 \cdot \pi} = \frac{0.000333 \cdot 4}{0.012^2 \cdot \pi} = 2.95 \left[\frac{\text{m}}{\text{s}} \right]$$

The thus resulting flow loss is then:

$$\Delta p = 4.5 \cdot 869.4 \cdot \frac{2.95^2}{2} = 17000 \text{ [Pa]} = 0.17 \text{ [bar]}$$



Flow diameter and wall thickness

Determining tube size for hydraulic systems

Proper tube material, type and size for a given application and type of fitting is critical for efficient and trouble free operation of the fluid system. Selection of proper tubing involves choosing the right tube material, and determining the optimum tube size (O.D. and wall thickness).

Proper sizing of the tube for various parts of a hydraulic system results in an optimum combination of efficient and cost effective performance.

A tube that is too small causes high fluid velocity, which has many detrimental effects. In pressure lines, it causes high friction losses and turbulence, both resulting in high pressure drops and heat generation. High heat accelerates wear in moving parts and rapid aging of seals and hoses, all resulting in reduced component life. High heat generation also means wasted energy, and hence, low efficiency.

Too large tubes increase system cost. Thus, optimum tube sizing is very critical. The following is a simple procedure for sizing the tubes.

Determine required flow diameter

Use table to determine recommended flow diameter for the required flow rate and type of line.

The table is based on the following recommended flow velocities:

$$\text{Pressure lines} - 3 \rightarrow 5 \left[\frac{\text{m}}{\text{s}} \right]$$

Avoid flow rates > 8 m/s!
The resulting forces are high and can destroy the tube lines.

$$\text{Return lines} - 2 \rightarrow 4 \left[\frac{\text{m}}{\text{s}} \right]$$

$$\text{Suction lines} - 1 \left[\frac{\text{m}}{\text{s}} \right]$$

If you desire to use different velocities than the above, use one of the following formula to determine the required flow diameter.

$$\text{Tube - I.D. [mm]} = 4.61 * \sqrt{\frac{\text{Flow} \left[\frac{\text{ltr.}}{\text{min}} \right]}{\text{Velocity} \left[\frac{\text{m}}{\text{s}} \right]}}$$

Determine required wall thickness

Use 2nd table to determine recommended wall thickness for the required working pressure and flow diameter of the line. Therefore choose an working pressure which is equal or higher than the required working pressure.

For other tubes and tube materials you have to calculate the wall thickness and working pressure acc. to the formula shown in the tube chapter.

Maximum flow l/min	Flow diameter in millimeters		
	5 m/s Pressure lines	3 m/s Return lines	1 m/s Suction lines
1	2.1	2.7	4.6
2	2.9	3.8	6.5
3	3.6	4.6	8.0
4	4.1	5.3	9.2
5	4.6	6.0	10.3
6	5.1	6.5	11.3
7	5.5	7.0	12.2
8	5.8	7.5	13.0
9	6.2	8.0	13.8
10	6.5	8.4	14.6
12	7.1	9.2	16.0
14	7.7	10.0	17.2
16	8.2	10.6	18.4
18	8.7	11.3	19.6
20	9.2	11.9	20.6
22	9.7	12.5	21.6
24	10.1	13.0	22.6
26	10.5	13.6	23.5
28	10.9	14.1	24.4
30	11.3	14.6	25.3
32	11.7	15.1	26.1
34	12.0	15.5	26.9
36	12.4	16.0	27.7
38	12.7	16.4	28.4
40	13.0	16.8	29.2
45	13.8	17.9	30.9
50	14.6	18.8	32.6
55	15.3	19.7	34.2
60	16.0	20.6	35.7
65	16.6	21.5	37.2
70	17.2	22.3	38.6
75	17.9	23.1	39.9
80	18.4	23.8	41.2
85	19.0	24.5	42.5
90	19.6	25.3	43.7
95	20.1	25.9	44.9
100	20.6	26.6	46.1
110	21.6	27.9	48.4
120	22.6	29.2	50.5
130	23.5	30.3	52.6
140	24.4	31.5	54.5
150	25.3	32.6	56.5
160	26.1	33.7	58.3
170	26.9	34.7	60.1
180	27.7	35.7	61.8
190	28.4	36.7	63.5
200	29.2	37.6	65.2
220	30.6	39.5	68.4
240	31.9	41.2	71.4
260	33.2	42.9	74.3
280	34.5	44.5	77.1
300	35.7	46.1	79.8
320	36.9	47.6	82.5
340	38.0	49.1	85.0
360	39.1	50.5	87.5
380	40.2	51.9	89.9
400	41.2	53.2	92.2
450	43.7	56.5	97.8
500	46.1	59.5	103.1





Hydraulic & Offshore Supplies

Tube wall thickness

Flow diameter [mm]	Max. working pressure [bar] for steel tubes St37.4 NBK calculated acc. to DIN 2413 III for dynamic load										
	Tube wall thickness [mm]										
	0.5	1	1.5	2	2.5	3	3.5	4	5	6	8
1.0	551	692	757	794	818						
1.5	458	614	692	740	771	794					
2.0	391	551	638	692	730	757	778	794			
2.5	342	500	591	651	692	723	747	766	794		
3.0	303	458	551	614	659	692	719	740	771	794	
4.0	248	391	485	551	600	638	668	692	730	757	794
5.0	209	342	433	500	551	591	624	651	692	723	766
6.0	181	303	391	458	509	551	585	614	659	692	740
7.0	160	273	357	422	474	516	551	581	628	664	715
8.0	143	248	328	391	443	485	521	551	600	638	692
9.0	129	227	303	365	415	458	494	524	575	614	671
10.0	118	209	282	342	391	433	469	500	551	591	651
11.0	108	194	264	321	370	411	447	478	529	570	632
12.0	100	181	248	303	351	391	427	458	509	551	614
13.0	93	170	233	287	333	373	408	439	491	533	597
14.0	87	160	221	273	318	357	391	422	474	516	581
15.0	82	151	209	260	303	342	376	406	458	500	565
16.0	77	143	199	248	290	328	361	391	443	485	551
17.0	73	136	190	237	278	315	348	378	429	471	537
18.0	69	129	181	227	267	303	336	365	415	458	524
19.0	66	123	173	218	257	292	324	353	403	445	512
20.0	63	118	166	209	248	282	313	342	391	433	500
21.0	60	113	160	202	239	273	303	331	380	422	489
22.0	58	108	154	194	231	264	294	321	370	411	478
23.0	55	104	148	188	223	256	285	312	360	401	468
24.0	53	100	143	181	216	248	277	303	351	391	458
25.0	51	97	138	175	209	240	269	295	342	382	448
26.0	49	93	133	170	203	233	261	287	333	373	439
27.0	48	90	129	165	197	227	254	280	325	365	430
28.0	46	87	125	160	192	221	248	273	318	357	422
29.0	44	85	121	155	186	215	241	266	310	349	414
30.0	43	82	118	151	181	209	235	260	303	342	406
31.0	42	80	115	147	177	204	230	254	297	335	399
32.0	40	77	111	143	172	199	224	248	290	328	391
33.0	39	75	108	139	168	194	219	242	284	321	384
34.0	38	73	106	136	164	190	214	237	278	315	378
35.0	37	71	103	132	160	185	209	232	273	309	371
36.0	36	69	100	129	156	181	205	227	267	303	365
37.0	35	68	98	126	153	177	200	222	262	298	359
38.0	34	66	96	123	149	173	196	218	257	292	353
39.0	33	64	93	121	146	170	192	213	252	287	347
40.0	33	63	91	118	143	166	188	209	248	282	342
42.0	31	60	87	113	137	160	181	202	239	273	331
44.0	30	58	84	108	132	154	175	194	231	264	321
46.0	29	55	80	104	127	148	168	188	223	256	312
48.0	27	53	77	100	122	143	163	181	216	248	303
50.0	26	51	75	97	118	138	157	175	209	240	295
52.0	25	49	72	93	114	133	152	170	203	233	287
54.0	24	48	69	90	110	129	147	165	197	227	280
56.0	24	46	67	87	107	125	143	160	192	221	273
58.0	23	44	65	85	103	121	139	155	186	215	266
60.0	22	43	63	82	100	118	135	151	181	209	260
65.0	20	40	58	76	93	110	126	141	170	197	245
70.0	19	37	55	71	87	103	118	132	160	185	232
75.0	18	35	51	67	82	97	111	125	151	175	220
80.0	17	33	48	63	77	91	105	118	143	166	209