



# Hydraulic & Offshore Supplies

t: +44(0)191 549 7335

e: [hose@hos.co.uk](mailto:hose@hos.co.uk)

w: [www.hos.co.uk](http://www.hos.co.uk)

## Hip Medium Pressure Valves, Fittings & Tubing



# High Pressure Equipment

## Medium Pressure Valves, Fittings and Tubing 20,000 psi service

High Pressure Equipment Company has developed a line of Medium Pressure products to assure safe and easy plumbing through 20,000 psi. These needle valves, fittings, line filters, check valves, safety heads, rupture discs, anti-vibration gland assemblies, tubing and nipples are engineered to the highest standards of repeatable quality. The reliable performance of these products has made HiP one of the world's leading suppliers of elevated pressure components.

Medium Pressure components use a compact coned-and-threaded connection which permits the larger bore sizes and increased flow rates common in this pressure class. Medium Pressure valves are available in  $\frac{1}{4}$ " ,  $\frac{3}{8}$ " ,  $\frac{9}{16}$ " ,  $\frac{3}{4}$ " , and 1" O.D. tubing sizes and five patterns to satisfy widely varied requirements. A line of fittings is available to facilitate adapting to Taper Seal, High Pressure or other threaded pipe systems.

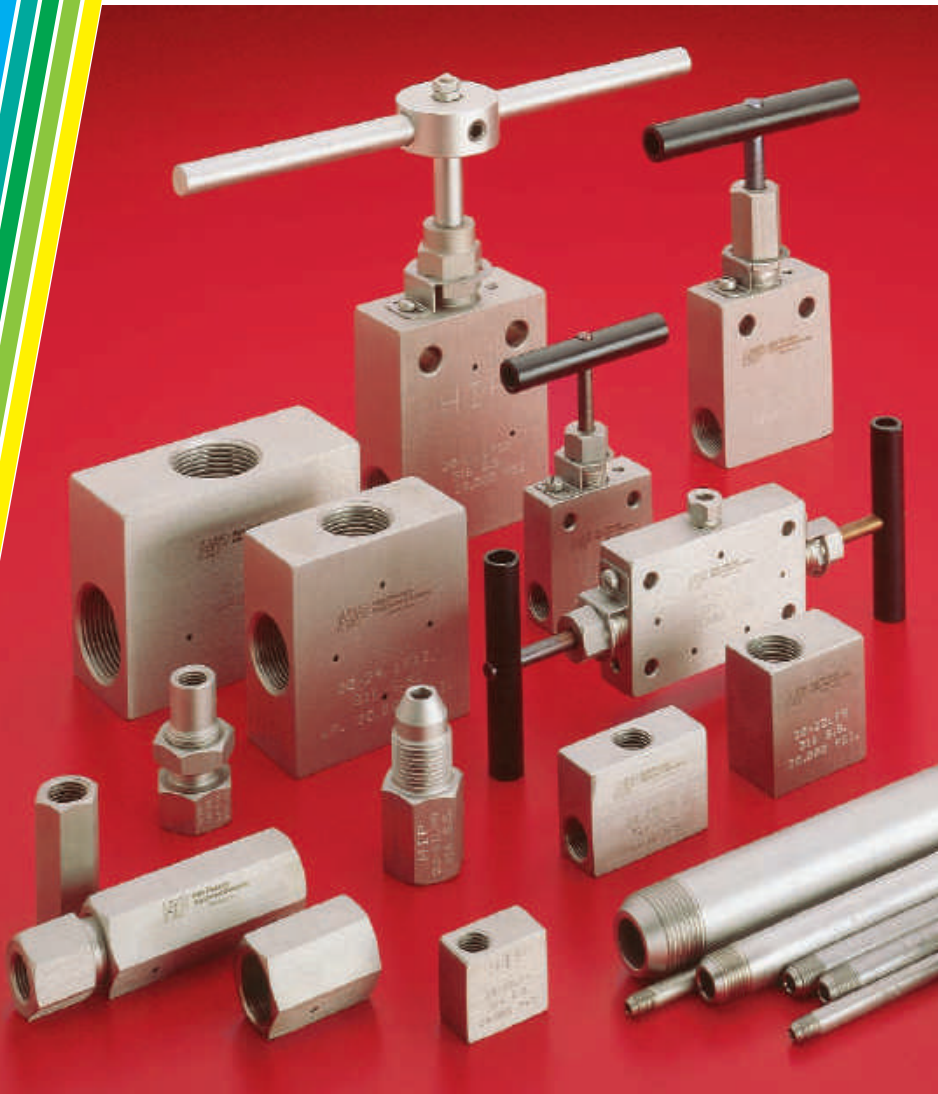

### Index

Page

20,000 psi Valves* . . . . .	3.2-3.3
Fittings . . . . .	3.4
Unions, Bulkheads & Caps . . . . .	3.5
Line Filters & Check Valves . . . . .	3.6
Safety Heads & Rupture Discs . . . . .	3.7
Anti-Vibration Gland Assemblies . . . . .	3.8
Tubing . . . . .	3.9
Coned & Threaded Nipples . . . . .	3.9
Connection Details . . . . .	3.A
	Appendix

\*Note: 10,000 psi large orifice is offered in  $\frac{3}{4}$ " and 1" size.

## High Pressure Equipment

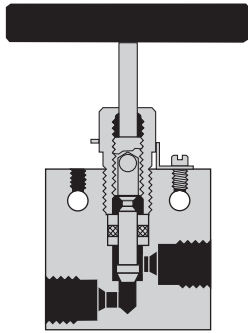

LF4 ( $\frac{1}{4}$ " ) and LF6 ( $\frac{3}{8}$ " )

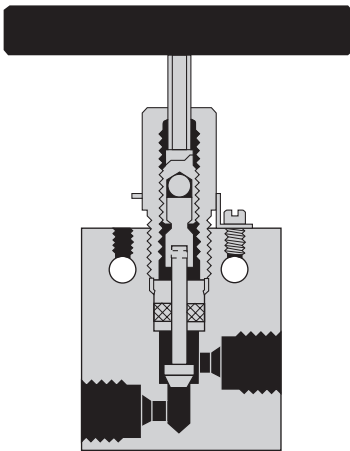

LF9 ( $\frac{9}{16}$ " )

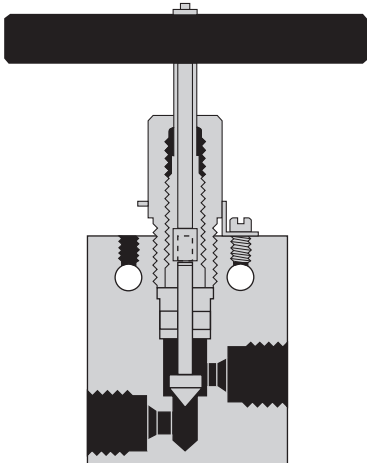

LF12 ( $\frac{3}{4}$ " ) and LF16 (1" )\*

### 20,000 psi Medium Pressure Valves

**Medium Pressure (coned & threaded)** type connections for  $\frac{1}{4}$ " ,  $\frac{3}{8}$ " ,  $\frac{9}{16}$ " ,  $\frac{3}{4}$ " , and 1" O.D. tubing.

**Non-rotating tip stems** are standard for on-off service and insure long life on valve seats. Regulating tip stems are available for all valves at no additional cost, add - REG to part number.

**Glands and collars** for tubing are supplied with each valve unless otherwise requested (glands and collars shown on pages 3.4 and 3.A).

**Materials** include high tensile type 316 stainless steel bodies and hardened 17-4PH stainless steel lower section stems.

**Packing** is Teflon (450°F) standard with optional Viton (350°F), BUNA-N (200°F) and Grafoil (800°F) available at no additional cost.

**Air operators** for remote control operation are available for all valves. (Select required valve and add "HIPCO". Refer to section 7.0 for additional data).

**High temperatures** can be accommodated by using extended stuffing boxes (see page 6.4).

#### Valve Features

- Non-rotating stem tips
- Packing below stem threads
- Type 316 ss high tensile bodies
- Positive gland lock device
- No stem adjustment needed
- Black T-handles or choice of 4 colors
- Tube sizes  $\frac{1}{4}$ " through 1"

\*Note: 10,000 psi large orifice is offered in  $\frac{3}{4}$ " and 1" size.

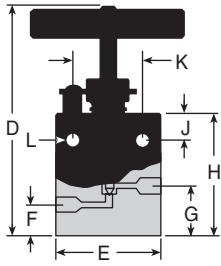

## Two Way Straight Valves

Tubeing	Catalog No.	psi	Connection	Orifice	D	E	F	G	H	J	K	L	Thickness
1/4" O.D.	20-11LF4	20,000	LF4	1/8"	4 <sup>3</sup> / <sub>8</sub> "	2"	3/8"	1 <sup>3</sup> / <sub>16</sub> "	2"	3/8"	1 <sup>1</sup> / <sub>4</sub> "	7/32"	3/4"
3/8" O.D.	20-11LF6	20,000	LF6	1 <sup>3</sup> / <sub>64</sub> "	4 <sup>3</sup> / <sub>8</sub> "	2"	3/8"	1 <sup>3</sup> / <sub>16</sub> "	2"	3/8"	1 <sup>1</sup> / <sub>4</sub> "	7/32"	3/4"
9/16" O.D.	20-11LF9	20,000	LF9	5/16"	6 <sup>7</sup> / <sub>8</sub> "	2 <sup>1</sup> / <sub>2</sub> "	1/2"	1 <sup>1</sup> / <sub>8</sub> "	2 <sup>7</sup> / <sub>8</sub> "	1/2"	1 <sup>3</sup> / <sub>8</sub> "	1 <sup>1</sup> / <sub>32</sub> "	1"
3/4" O.D.	20-11LF12	20,000	LF12	7/16"	7"	3"	3/4"	1 <sup>1</sup> / <sub>2</sub> "	3 <sup>3</sup> / <sub>4</sub> "	5/8"	1 <sup>3</sup> / <sub>4</sub> "	7/16"	1 <sup>3</sup> / <sub>8</sub> "
3/4" O.D.	10-11LF12	10,000	LF12	3 <sup>3</sup> / <sub>64</sub> "	7"	3"	3/4"	1 <sup>1</sup> / <sub>2</sub> "	3 <sup>3</sup> / <sub>4</sub> "	5/8"	1 <sup>3</sup> / <sub>4</sub> "	7/16"	1 <sup>3</sup> / <sub>8</sub> "
1" O.D.	20-11LF16	20,000	LF16	9/16"	8 <sup>27</sup> / <sub>64</sub> "	4 <sup>1</sup> / <sub>8</sub> "	7/8"	1 <sup>13</sup> / <sub>16</sub> "	4 <sup>5</sup> / <sub>8</sub> "	1 <sup>1</sup> / <sub>8</sub> "	2 <sup>1</sup> / <sub>2</sub> "	9/16"	1 <sup>3</sup> / <sub>4</sub> "
1" O.D.	10-11LF16	10,000	LF16	1 <sup>1</sup> / <sub>16</sub> "	8 <sup>27</sup> / <sub>64</sub> "	4 <sup>1</sup> / <sub>8</sub> "	7/8"	1 <sup>13</sup> / <sub>16</sub> "	4 <sup>5</sup> / <sub>8</sub> "	1 <sup>1</sup> / <sub>8</sub> "	2 <sup>1</sup> / <sub>2</sub> "	9/16"	1 <sup>3</sup> / <sub>4</sub> "

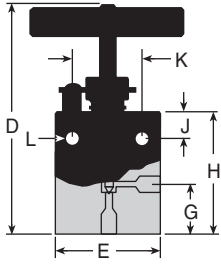

## Two Way Angle Valves

Tubeing	Catalog No.	psi	Connection	Orifice	D	E	F	G	H	J	K	L	Thickness
1/4" O.D.	20-12LF4	20,000	LF4	1/8"	4 <sup>13</sup> / <sub>16</sub> "	2"	—	1 <sup>1</sup> / <sub>4</sub> "	2 <sup>7</sup> / <sub>16</sub> "	3/8"	1 <sup>1</sup> / <sub>4</sub> "	7/32"	3/4"
3/8" O.D.	20-12LF6	20,000	LF6	1 <sup>3</sup> / <sub>64</sub> "	4 <sup>13</sup> / <sub>16</sub> "	2"	—	1 <sup>1</sup> / <sub>4</sub> "	2 <sup>7</sup> / <sub>16</sub> "	3/8"	1 <sup>1</sup> / <sub>4</sub> "	7/32"	3/4"
9/16" O.D.	20-12LF9	20,000	LF9	5/16"	6 <sup>5</sup> / <sub>8</sub> "	2 <sup>1</sup> / <sub>2</sub> "	—	1 <sup>5</sup> / <sub>8</sub> "	3 <sup>3</sup> / <sub>8</sub> "	1/2"	1 <sup>3</sup> / <sub>8</sub> "	1 <sup>1</sup> / <sub>32</sub> "	1"
3/4" O.D.	20-12LF12	20,000	LF12	7/16"	7 <sup>1</sup> / <sub>2</sub> "	3"	—	2"	4 <sup>1</sup> / <sub>4</sub> "	5/8"	1 <sup>3</sup> / <sub>4</sub> "	7/16"	1 <sup>3</sup> / <sub>8</sub> "
3/4" O.D.	10-12LF12	10,000	LF12	3 <sup>3</sup> / <sub>64</sub> "	7 <sup>1</sup> / <sub>2</sub> "	3"	—	2"	4 <sup>1</sup> / <sub>4</sub> "	5/8"	1 <sup>3</sup> / <sub>4</sub> "	7/16"	1 <sup>3</sup> / <sub>8</sub> "
1" O.D.	20-12LF16	20,000	LF16	9/16"	9 <sup>3</sup> / <sub>8</sub> "	4 <sup>1</sup> / <sub>8</sub> "	—	2 <sup>9</sup> / <sub>16</sub> "	5 <sup>7</sup> / <sub>16</sub> "	1 <sup>1</sup> / <sub>8</sub> "	2 <sup>1</sup> / <sub>2</sub> "	9/16"	1 <sup>3</sup> / <sub>4</sub> "
1" O.D.	10-12LF16	10,000	LF16	1 <sup>1</sup> / <sub>16</sub> "	9 <sup>3</sup> / <sub>8</sub> "	4 <sup>1</sup> / <sub>8</sub> "	—	2 <sup>9</sup> / <sub>16</sub> "	5 <sup>7</sup> / <sub>16</sub> "	1 <sup>1</sup> / <sub>8</sub> "	2 <sup>1</sup> / <sub>2</sub> "	9/16"	1 <sup>3</sup> / <sub>4</sub> "

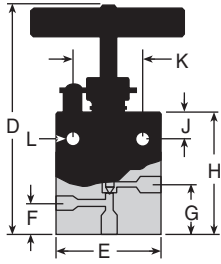

## Three Way Valves / Two Pressure Connections

Tubeing	Catalog No.	psi	Connection	Orifice	D	E	F	G	H	J	K	L	Thickness
1/4" O.D.	20-13LF4	20,000	LF4	1/8"	5"	2"	1"	1 <sup>7</sup> / <sub>16</sub> "	2 <sup>5</sup> / <sub>8</sub> "	3/8"	1 <sup>1</sup> / <sub>4</sub> "	7/32"	3/4"
3/8" O.D.	20-13LF6	20,000	LF6	1 <sup>3</sup> / <sub>64</sub> "	5"	2"	1"	1 <sup>7</sup> / <sub>16</sub> "	2 <sup>5</sup> / <sub>8</sub> "	3/8"	1 <sup>1</sup> / <sub>4</sub> "	7/32"	3/4"
9/16" O.D.	20-13LF9	20,000	LF9	5/16"	6 <sup>7</sup> / <sub>8</sub> "	2 <sup>1</sup> / <sub>2</sub> "	1 <sup>1</sup> / <sub>4</sub> "	1 <sup>7</sup> / <sub>8</sub> "	3 <sup>5</sup> / <sub>8</sub> "	1/2"	1 <sup>3</sup> / <sub>8</sub> "	1 <sup>1</sup> / <sub>32</sub> "	1"
3/4" O.D.	20-13LF12	20,000	LF12	7/16"	7 <sup>7</sup> / <sub>8</sub> "	3"	2 <sup>5</sup> / <sub>8</sub> "	2 <sup>3</sup> / <sub>8</sub> "	4 <sup>5</sup> / <sub>8</sub> "	5/8"	1 <sup>3</sup> / <sub>4</sub> "	7/16"	1 <sup>3</sup> / <sub>8</sub> "
3/4" O.D.	10-13LF12	10,000	LF12	3 <sup>3</sup> / <sub>64</sub> "	7 <sup>7</sup> / <sub>8</sub> "	3"	2 <sup>5</sup> / <sub>8</sub> "	2 <sup>3</sup> / <sub>8</sub> "	4 <sup>5</sup> / <sub>8</sub> "	5/8"	1 <sup>3</sup> / <sub>4</sub> "	7/16"	1 <sup>3</sup> / <sub>8</sub> "
1" O.D.	20-13LF16	20,000	LF16	9/16"	9 <sup>3</sup> / <sub>4</sub> "	4 <sup>1</sup> / <sub>8</sub> "	2 <sup>1</sup> / <sub>8</sub> "	3 <sup>1</sup> / <sub>16</sub> "	5 <sup>7</sup> / <sub>8</sub> "	1 <sup>1</sup> / <sub>8</sub> "	2 <sup>1</sup> / <sub>2</sub> "	9/16"	1 <sup>3</sup> / <sub>4</sub> "
1" O.D.	10-13LF16	10,000	LF16	1 <sup>1</sup> / <sub>16</sub> "	9 <sup>3</sup> / <sub>4</sub> "	4 <sup>1</sup> / <sub>8</sub> "	2 <sup>1</sup> / <sub>8</sub> "	3 <sup>1</sup> / <sub>16</sub> "	5 <sup>7</sup> / <sub>8</sub> "	1 <sup>1</sup> / <sub>8</sub> "	2 <sup>1</sup> / <sub>2</sub> "	9/16"	1 <sup>3</sup> / <sub>4</sub> "

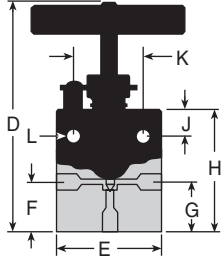

## Three Way Valves / One Pressure Connection

Tubeing	Catalog No.	psi	Connection	Orifice	D	E	F	G	H	J	K	L	Thickness
1/4" O.D.	20-14LF4	20,000	LF4	1/8"	4 <sup>13</sup> / <sub>16</sub> "	2"	1 <sup>1</sup> / <sub>4</sub> "	1 <sup>1</sup> / <sub>4</sub> "	2 <sup>7</sup> / <sub>16</sub> "	3/8"	1 <sup>1</sup> / <sub>4</sub> "	7/32"	3/4"
3/8" O.D.	20-14LF6	20,000	LF6	1 <sup>3</sup> / <sub>64</sub> "	4 <sup>13</sup> / <sub>16</sub> "	2"	1 <sup>1</sup> / <sub>4</sub> "	1 <sup>1</sup> / <sub>4</sub> "	2 <sup>7</sup> / <sub>16</sub> "	3/8"	1 <sup>1</sup> / <sub>4</sub> "	7/32"	3/4"
9/16" O.D.	20-14LF9	20,000	LF9	5/16"	6 <sup>5</sup> / <sub>8</sub> "	2 <sup>1</sup> / <sub>2</sub> "	1 <sup>5</sup> / <sub>8</sub> "	1 <sup>5</sup> / <sub>8</sub> "	3 <sup>3</sup> / <sub>8</sub> "	1/2"	1 <sup>3</sup> / <sub>8</sub> "	1 <sup>1</sup> / <sub>32</sub> "	1"
3/4" O.D.	20-14LF12	20,000	LF12	7/16"	7 <sup>1</sup> / <sub>2</sub> "	3"	2"	2"	4 <sup>1</sup> / <sub>4</sub> "	5/8"	1 <sup>3</sup> / <sub>4</sub> "	7/16"	1 <sup>3</sup> / <sub>8</sub> "
3/4" O.D.	10-14LF12	10,000	LF12	3 <sup>3</sup> / <sub>64</sub> "	7 <sup>1</sup> / <sub>2</sub> "	3"	2"	2"	4 <sup>1</sup> / <sub>4</sub> "	5/8"	1 <sup>3</sup> / <sub>4</sub> "	7/16"	1 <sup>3</sup> / <sub>8</sub> "
1" O.D.	20-14LF16	20,000	LF16	9/16"	9 <sup>3</sup> / <sub>8</sub> "	4 <sup>1</sup> / <sub>8</sub> "	2 <sup>5</sup> / <sub>8</sub> "	2 <sup>5</sup> / <sub>8</sub> "	5 <sup>7</sup> / <sub>16</sub> "	1 <sup>1</sup> / <sub>8</sub> "	2 <sup>1</sup> / <sub>2</sub> "	9/16"	1 <sup>3</sup> / <sub>4</sub> "
1" O.D.	10-14LF16	10,000	LF16	1 <sup>1</sup> / <sub>16</sub> "	9 <sup>3</sup> / <sub>8</sub> "	4 <sup>1</sup> / <sub>8</sub> "	2 <sup>5</sup> / <sub>8</sub> "	2 <sup>5</sup> / <sub>8</sub> "	5 <sup>7</sup> / <sub>16</sub> "	1 <sup>1</sup> / <sub>8</sub> "	2 <sup>1</sup> / <sub>2</sub> "	9/16"	1 <sup>3</sup> / <sub>4</sub> "

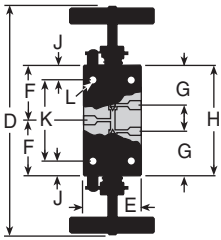

## Three Way / Two Stem Connection Valves

Tubeing	Catalog No.	psi	Connection	Orifice	D	E	F	G	H	J	K	L	Thickness
1/4" O.D.	20-15LF4	20,000	LF4	1/8"	5 <sup>3</sup> / <sub>4</sub> "	2"	1 <sup>11</sup> / <sub>16</sub> "	1 <sup>3</sup> / <sub>16</sub> "	3 <sup>3</sup> / <sub>8</sub> "	3/8"	1 <sup>1</sup> / <sub>4</sub> "	7/32"	3/4"
3/8" O.D.	20-15LF6	20,000	LF6	1 <sup>3</sup> / <sub>64</sub> "	5 <sup>3</sup> / <sub>4</sub> "	2"	1 <sup>11</sup> / <sub>16</sub> "	1 <sup>3</sup> / <sub>16</sub> "	3 <sup>3</sup> / <sub>8</sub> "	3/8"	1 <sup>1</sup> / <sub>4</sub> "	7/32"	3/4"
9/16" O.D.	20-15LF9	20,000	LF9	5/16"	8 <sup>3</sup> / <sub>8</sub> "	2 <sup>1</sup> / <sub>2</sub> "	2 <sup>2</sup> / <sub>16</sub> "	1 <sup>3</sup> / <sub>4</sub> "	5 <sup>1</sup> / <sub>8</sub> "	1/2"	1 <sup>3</sup> / <sub>8</sub> "	1 <sup>1</sup> / <sub>32</sub> "	1"
3/4" O.D.	20-15LF12	20,000	LF12	7/16"	9 <sup>3</sup> / <sub>4</sub> "	3"	3 <sup>1</sup> / <sub>4</sub> "	2 <sup>1</sup> / <sub>4</sub> "	6 <sup>1</sup> / <sub>2</sub> "	5/8"	1 <sup>3</sup> / <sub>4</sub> "	7/16"	1 <sup>3</sup> / <sub>8</sub> "
3/4" O.D.	10-15LF12	10,000	LF12	3 <sup>3</sup> / <sub>64</sub> "	9 <sup>3</sup> / <sub>4</sub> "	3"	3 <sup>1</sup> / <sub>4</sub> "	2 <sup>1</sup> / <sub>4</sub> "	6 <sup>1</sup> / <sub>2</sub> "	5/8"	1 <sup>3</sup> / <sub>4</sub> "	7/16"	1 <sup>3</sup> / <sub>8</sub> "
1" O.D.	20-15LF16	20,000	LF16	9/16"	12 <sup>3</sup> / <sub>16</sub> "	4 <sup>1</sup> / <sub>8</sub> "	4 <sup>1</sup> / <sub>8</sub> "	2 <sup>13</sup> / <sub>16</sub> "	8 <sup>1</sup> / <sub>4</sub> "	1 <sup>1</sup> / <sub>8</sub> "	2 <sup>1</sup> / <sub>2</sub> "	9/16"	1 <sup>3</sup> / <sub>4</sub> "
1" O.D.	10-15LF16	10,000	LF16	1 <sup>1</sup> / <sub>16</sub> "	12 <sup>3</sup> / <sub>16</sub> "	4 <sup>1</sup> / <sub>8</sub> "	4 <sup>1</sup> / <sub>8</sub> "	2 <sup>13</sup> / <sub>16</sub> "	8 <sup>1</sup> / <sub>4</sub> "	1 <sup>1</sup> / <sub>8</sub> "	2 <sup>1</sup> / <sub>2</sub> "	9/16"	1 <sup>3</sup> / <sub>4</sub> "

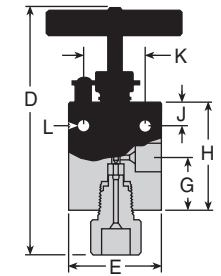

## Replaceable Seat Valves



Tubeing	Catalog No.	psi	Connection	Orifice	D	E	F	G	H	J	K	L	Thickness
1/4" O.D.	20-12LF4-R	20,000	LF4	1/8"	5 <sup>3</sup> / <sub>8</sub> "	2"	—	1 <sup>1</sup> / <sub>4</sub> "	2 <sup>7</sup> / <sub>16</sub> "	3/8"	1 <sup>1</sup> / <sub>4</sub> "	7/32"	3/4"
3/8" O.D.	20-12LF6-R	20,000	LF6	1 <sup>3</sup> / <sub>64</sub> "	5 <sup>3</sup> / <sub>8</sub> "	2"	—	1 <sup>1</sup> / <sub>4</sub> "	2 <sup>7</sup> / <sub>16</sub> "	3/8"	1 <sup>1</sup> / <sub>4</sub> "	7/32"	3/4"
9/16" O.D.	20-12LF9-R	20,000	LF9	5/16"	8"	2 <sup>1</sup> / <sub>2</sub> "	—	1 <sup>5</sup> / <sub>8</sub> "	3 <sup>3</sup> / <sub>8</sub> "	1/2"	1 <sup>3</sup> / <sub>8</sub> "	1 <sup>1</sup> / <sub>32</sub> "	1"
3/4" O.D.	20-12LF12-R	20,000	LF12	7/16"	8 <sup>7</sup> / <sub>8</sub> "	3"	—	2"	4 <sup>1</sup> / <sub>4</sub> "	5/8"	1 <sup>3</sup> / <sub>4</sub> "	7/16"	1 <sup>3</sup> / <sub>8</sub> "
3/4" O.D.	10-12LF12-R	10,000	LF12	3 <sup>3</sup> / <sub>64</sub> "	8 <sup>7</sup> / <sub>8</sub> "	3"	—	2"	4 <sup>1</sup> / <sub>4</sub> "	5/8"	1 <sup>3</sup> / <sub>4</sub> "	7/16"	1 <sup>3</sup> / <sub>8</sub> "
1" O.D.	20-12LF16-R	20,000	LF16	9/16"	11 <sup>1</sup> / <sub>8</sub> "	4 <sup>1</sup> / <sub>8</sub> "	—	2 <sup>9</sup> / <sub>16</sub> "	5 <sup>7</sup> / <sub>16</sub> "	1 <sup>1</sup> / <sub>8</sub> "	2 <sup>1</sup> / <sub>2</sub> "	9/16"	1 <sup>3</sup> / <sub>4</sub> "
1" O.D.	10-12LF16-R	10,000	LF16	1 <sup>1</sup> / <sub>16</sub> "	11 <sup>1</sup> / <sub>8</sub> "	4 <sup>1</sup> / <sub>8</sub> "	—	2 <sup>9</sup> / <sub>16</sub> "	5 <sup>7</sup> / <sub>16</sub> "	1 <sup>1</sup> / <sub>8</sub> "	2 <sup>1</sup> / <sub>2</sub> "	9/16"	1 <sup>3</sup> / <sub>4</sub> "

# High Pressure Equipment

## Glands/Collars/Plugs Elbows/Tees/Crosses

A complete range of elbows, tees, and crosses is available for all of the tubing connection sizes. Material is high tensile 316 stainless steel. Standard tubing glands and collars are provided unless otherwise specified.

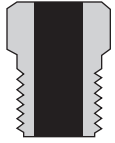
### Connection Components

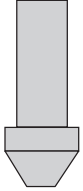
Catalog No.	Tube Size	Gland	Catalog No.	Tube Size	Collar	Catalog No.	Tube Size	Plug
20-2LM4	1/4"		20-2L4	1/4"		20-7LM4	1/4"	
20-2LM6	3/8"		20-2L6	3/8"		20-7LM6	3/8"	
20-2LM9	9/16"		20-2L9	9/16"		20-7LM9	9/16"	
20-2LM12	3/4"		20-2L12	3/4"		20-7LM12	3/4"	
20-2LM16	1"		20-2L16	1"		20-7LM16	1"	

### Medium Pressure Elbows

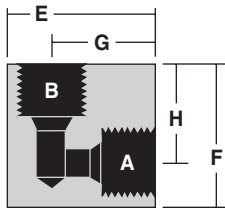

Catalog No.	Pressure Rating psi	Connections	A-B	E	F	G	H	Thickness
20-22LF4	20,000	1/4" O.D. TUBE	LF4	1 3/16"	1"	7/8"	1 1/16"	5/8"
20-22LF6	20,000	3/8" O.D. TUBE	LF6	1 3/8"	1 3/8"	1"	1"	3/4"
20-22LF9	20,000	9/16" O.D. TUBE	LF9	1 3/4"	1 3/4"	1 1/4"	1 1/4"	1"
20-22LF12	20,000	3/4" O.D. TUBE	LF12	2 1/4"	2 1/4"	1 1/2"	1 1/2"	1 3/8"
20-22LF16	20,000	1" O.D. TUBE	LF16	3"	3"	2 1/16"	2 1/16"	1 3/4"

### Medium Pressure Tees

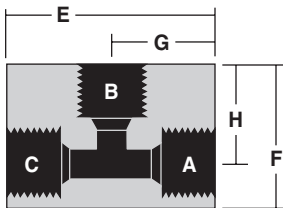

Catalog No.	Pressure Rating psi	Connections	A-B-C	E	F	G	H	Thickness
20-23LF4	20,000	1/4" O.D. TUBE	LF4	1 3/4"	1"	7/8"	1 1/16"	5/8"
20-23LF6	20,000	3/8" O.D. TUBE	LF6	2"	1 3/8"	1"	1"	3/4"
20-23LF9	20,000	9/16" O.D. TUBE	LF9	2 1/2"	1 3/4"	1 1/4"	1 1/4"	1"
20-23LF12	20,000	3/4" O.D. TUBE	LF12	3"	2 1/4"	1 1/2"	1 1/2"	1 3/8"
20-23LF16	20,000	1" O.D. TUBE	LF16	4 1/8"	3"	2 1/16"	2 1/16"	1 3/4"

### Medium Pressure Crosses

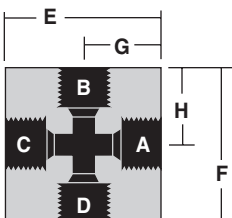

Catalog No.	Pressure Rating psi	Connections	A-B-C-D	E	F	G	H	Thickness
20-24LF4	20,000	1/4" O.D. TUBE	LF4	1 3/4"	1 3/8"	7/8"	1 1/16"	5/8"
20-24LF6	20,000	3/8" O.D. TUBE	LF6	2"	2"	1"	1"	3/4"
20-24LF9	20,000	9/16" O.D. TUBE	LF9	2 1/2"	2 1/2"	1 1/4"	1 1/4"	1"
20-24LF12	20,000	3/4" O.D. TUBE	LF12	3"	3"	1 1/2"	1 1/2"	1 3/8"
20-24LF16	20,000	1" O.D. TUBE	LF16	4 1/8"	4 1/8"	2 1/16"	2 1/16"	1 3/4"

## Union Couplings (Slip Type)

Union (slip type) couplings are ideal for use in confined space installations. This design allows the entire coupling to be disconnected and slipped back over the tubing to facilitate assembly and disassembly. In installations where tubing is easily assembled, it is preferable (and less expensive) to use standard straight couplings (see section 8.0). Standard material is high tensile 316 stainless steel. Standard tubing collars and glands are provided unless otherwise specified.

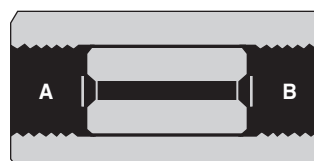

Catalog No.	Tubing	psi	A	B	Orifice	Length	Hex
20-21LF4-U	1/4" O.D.	20,000	LF4	LF4	1/8"	1 9/16"	5/8"
20-21LF6-U	3/8" O.D.	20,000	LF6	LF6	7/32"	1 3/4"	3/4"
20-21LF9-U	9/16" O.D.	20,000	LF9	LF9	23/64"	2 1/8"	1"
20-21LF12-U	3/4" O.D.	20,000	LF12	LF12	33/64"	2 1/2"	1 3/8"
20-21LF16-U	1" O.D.	20,000	LF16	LF16	11/16"	3 1/2"	1 3/4"

## Bulkhead Couplings

Bulkhead couplings are designed specifically for passing a tubing connection through a panel or steel barricade. These couplings include a locknut as shown. Material is high tensile 316 stainless steel. Standard tubing collars and glands are included unless otherwise specified.

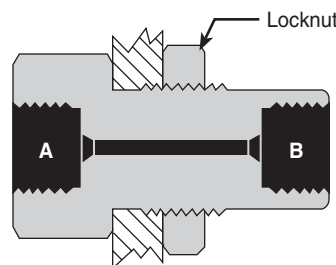

Catalog No.	Tubing	psi	Connections	Orifice	Length	Hex	Hole Diameter
20-21LF4-B	1/4" O.D.	20,000	LF4	1/8"	1 7/8"	1"	3/4" - 16
20-21LF6-B	3/8" O.D.	20,000	LF6	7/32"	2"	1"	7/8" - 14
20-21LF9-B	9/16" O.D.	20,000	LF9	23/64"	2 3/8"	1 3/8"	1 1/16" - 12
20-21LF12-B	3/4" O.D.	20,000	LF12	33/64"	2 5/8"	1 7/8"	1 5/8" - 12
20-21LF16-B	1" O.D.	20,000	LF-16	11/16"	3 1/2"	2 1/8"	1 7/8" - 12

## Caps

Tubing end caps are offered for use in sealing off tubing ends either for temporary use or permanent use such as on small volume reservoirs. Standard material is high tensile 316 stainless steel. Standard tubing collars and glands are provided unless otherwise specified.

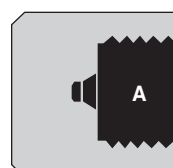

Catalog No.	Tubing	psi	A	Length	Hex
20-21LF4-C	1/4" O.D.	20,000	LF4	7/8"	5/8"
20-21LF6-C	3/8" O.D.	20,000	LF6	1 3/8"	3/4"
20-21LF9-C	9/16" O.D.	20,000	LF9	1 1/2"	1"
20-21LF12-C	3/4" O.D.	20,000	LF12	2 1/2"	1 3/8"
20-21LF16-C	1" O.D.	20,000	LF16	3"	1 3/4"

# High Pressure Equipment

## Line Filters

The line filters as shown utilize sintered stainless steel filter discs 3 pc./set. Porosities are available as per the chart to the right. If not otherwise specified, 100 micron filter discs are supplied. (One micron = 0.001 millimeters). Material of body, caps and cover is high tensile 316 stainless steel. Standard tubing glands and collars are provided unless otherwise specified.

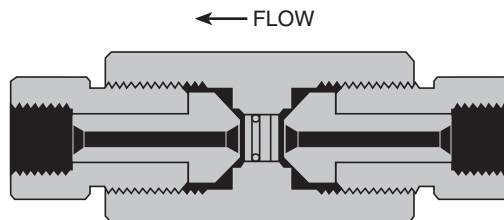

Catalog No.	Tubing	psi	Connections	Orifice	Length	Thickness	Micron Size Filter Available					
							0.5	2	5	10	40	100
20-51LF4	1/4" O.D.	20,000	LF4	1/8"	5 1/4"	1 3/8"	●	●	●	●	●	●
20-51LF6	3/8" O.D.	20,000	LF6	7/32"	5 1/4"	1 3/8"	●	●	●	●	●	●
20-51LF9	9/16" O.D.	20,000	LF9	23/64"	5 1/4"	1 3/8"	●	●	●	●	●	●

## Ball Check Valves

Ball type check valves insure flow in one direction only. Material for body, caps and cover is high tensile 316 stainless steel. Standard tubing glands and collars are provided unless otherwise specified.

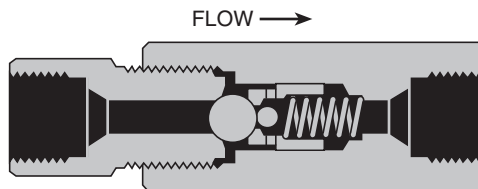

Catalog No.	Tubing	psi	Connections	Orifice	Length	Thickness
20-41LF4	1/4" O.D.	20,000	LF4	1/8"	3 3/4"	1"
20-41LF6	3/8" O.D.	20,000	LF6	7/32"	3 3/4"	1"
20-41LF9	9/16" O.D.	20,000	LF9	23/64"	4 1/2"	1 3/8"
20-41LF12	3/4" O.D.	20,000	LF12	7/16"	5 1/8"	1 3/4"
20-41LF16	1" O.D.	20,000	LF16	9/16"	6 1/2"	2 1/2"

Note: 20-41LF16 material 17-4PH

## Soft Seat Check Valves

Soft seat check valves insure flow in one direction only and can be mounted in any position. These are highly reliable for both gas and liquid service. Standard O-ring (soft seat) material for the sealing surface is Buna-N (nitrile) with other materials including Teflon and Viton available on request. Temperature is limited by the choice of O-ring material. Material of all other parts is high tensile 316 stainless steel. Standard glands and collars are provided unless otherwise specified.

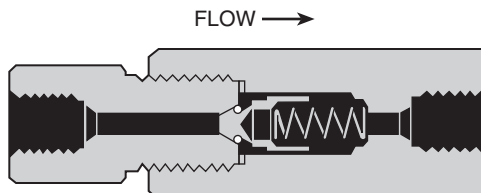

Catalog No.	Tubing	psi	Connections	Orifice	Length	Thickness
20-41LF4-T	1/4" O.D.	20,000	LF4	1/8"	3 3/4"	1"
20-41LF6-T	3/8" O.D.	20,000	LF6	7/32"	3 3/4"	1"
20-41LF9-T	9/16" O.D.	20,000	LF9	23/64"	4 1/2"	1 3/8"
20-41LF12-T	3/4" O.D.	20,000	LF12	7/16"	5 1/8"	1 3/4"
20-41LF16-T	1" O.D.	20,000	LF16	9/16"	6 1/2"	2 1/2"

Note: 20-41LF16 material 17-4PH

## Safety Heads

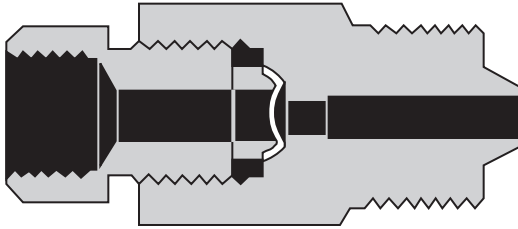

The male inlet design can be inserted directly into the tubing connections of valves and various fittings such as tees and crosses, or located in pressure vessels.

Outlet connections are  $\frac{3}{8}$ " pipe (NPT). This outlet may be connected to a suitable discharge line to vent pressure to a safe location in the event of bursting of the rupture disc. Torque required for sealing rupture discs will range from 40 to 90 foot pounds, depending upon pressure and media being used.

Material of body and hold down nut is high tensile 316 stainless steel. Standard tubing glands and collars are provided unless otherwise specified.

**Note:** Rupture discs are **not** included and must be ordered as a separate item.

Catalog No.	Tubing	psi	Connections	Orifice	Length	Hex
20-61LM4	$\frac{1}{4}$ " O.D.	20,000	LM4	0.125"	2"	1"
20-61LM6	$\frac{3}{8}$ " O.D.	20,000	LM6	0.219"	2"	1"
20-61LM9	$\frac{9}{16}$ " O.D.	20,000	LM9	0.250"	2 $\frac{1}{8}$ "	1"
20-61LM12	$\frac{3}{4}$ " O.D.	20,000	LM12	0.250"	2 $\frac{3}{8}$ "	1 $\frac{1}{8}$ "
20-61LM16	1" O.D.	20,000	LM16	0.250"	3 $\frac{1}{2}$ "	1 $\frac{1}{8}$ "

## Rupture Discs

### $\frac{1}{4}$ " Angled Seat

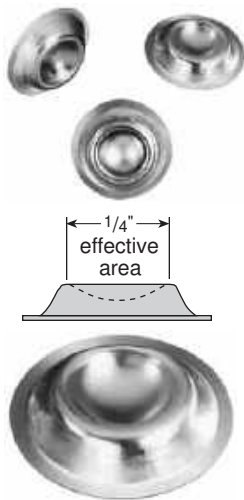

**SPECIAL DISCS** are available on special order for pressure ranges not shown above and in numerous materials and coatings. Consult factory for price and delivery.

Standard rupture discs are available from stock in burst pressures as listed in the chart below. All pressures through 20,000 psi are shaded. These discs are 316 stainless steel (except for 1,000 psi which are inconel) and may be used with any of the safety heads shown. Note that these rupture discs are supplied with a tolerance of plus 6% and minus 3% of specified burst pressure. Samples of each batch are tested and the actual average burst pressure is stamped on an accompanying metal tag. Factors influencing rupture disc life include corrosion, metal fatigue, and cyclic effects. Periodic replacement is recommended to prevent premature failure.

### Standard Burst Pressures (in psi at 72°F)

1,000	3,000	5,000	7,000	9,000	11,000	17,500	25,000	37,500	55,000
1,500	3,500	5,500	7,500	9,500	11,500	18,000	27,000	40,000	60,000
2,000	4,000	6,000	8,000	10,000	12,500	20,000	30,000	45,000	65,000
2,500	4,500	6,500	8,500	10,500	15,000	22,500	35,000	50,000	



# High Pressure Equipment

## Anti-Vibration Gland Assemblies

Tubing systems that are subject to extreme vibration or shock, such as mobile pressure systems or long tubing runs culminating at a compressor, will benefit from the use of High Pressure Equipment Company's Anti-Vibration Gland Assemblies. These assemblies utilize the same reliable connection geometries as the standard HiP fittings, with the added benefit of essentially unlimited vibrational fatigue life.

A coned and threaded tube, when subjected to unusual or excessive vibration, may fail prematurely and break at the last thread. The Anti-Vibration Gland Assembly acts to move the fulcrum of vibration away from the threaded portion of the tube and onto the strong, solid wall of the tubing. A wedge-like collet firmly holds the assembly in place, virtually eliminating premature tubing failure while reliably maintaining a leak-free connection between the tube and the connection seat.

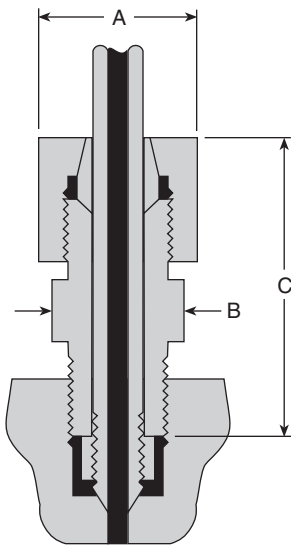

### Medium Pressure Anti-Vibration Gland Assemblies

Catalog No.	Pressure Rating psi	Connections	A	B	C
20-3LM4	20,000	1/4" MEDIUM PRESSURE	5/8"	1/2"	1 7/16"
20-3LM6	20,000	3/8" MEDIUM PRESSURE	3/4"	5/8"	1 5/8"
20-3LM9	20,000	9/16" MEDIUM PRESSURE	1"	7/8"	1 7/8"
20-3LM12	20,000	3/4" MEDIUM PRESSURE	1 1/4"	1 1/8"	2 1/8"
20-3LM16	20,000	1" MEDIUM PRESSURE	1 1/2"	1 3/8"	2 1/2"

### Anti-Vibration Components

Tubing Size	Slotted Collet	Collet Gland	Collet Body	Collar
1/4"	2-8769	2-8770	2-8768	20-2L4
3/8"	2-8772	2-8773	2-8771	20-2L6
9/16"	2-8775	2-8776	2-8774	20-2L9
3/4"	2-8778	2-8779	2-8777	20-2L12
1"	2-8781	2-8782	2-8780	20-2L16

## Medium Pressure Tubing

Tubing is cold drawn, seamless, and is supplied in the  $\frac{1}{8}$  hard condition (not annealed). Tensile strength is approximately 40 percent higher than that of annealed tubing. All tubing is manufactured in strict accordance with High Pressure Equipment Company specifications to insure tolerances and bore quality. Tubing is stocked in lengths of 18 to 22 feet but may be ordered in shorter lengths with **no additional cutting charge**.

	Tubing Size	Working Pressure psi	Type of Connection Used	Material	Catalog Order Number
$\frac{1}{4}$ "	$\frac{1}{4}$ " O.D. x 0.109" I.D.	20,000	$\frac{1}{4}$ " MEDIUM PRESSURE (LF4)	316 SS	20-9M4-316
$\frac{3}{8}$ "	$\frac{3}{8}$ " O.D. x 0.203" I.D.	20,000	$\frac{3}{8}$ " MEDIUM PRESSURE (LF6)	316 SS	20-9M6-316
$\frac{9}{16}$ "	$\frac{9}{16}$ " O.D. x 0.359" I.D.	10,000	$\frac{9}{16}$ " MEDIUM PRESSURE (LF9)	316 SS	10-9M9-316
	$\frac{9}{16}$ " O.D. x 0.312" I.D.	20,000		304 SS	20-9M9-304
				316 SS	20-9M9-316
$\frac{3}{4}$ "	$\frac{3}{4}$ " O.D. x 0.516" I.D.	10,000	$\frac{3}{4}$ " MEDIUM PRESSURE (LF12)	316 SS	10-9M12-316
	$\frac{3}{4}$ " O.D. x 0.438" I.D.	20,000			20-9M12-316
1"	1" O.D. x 0.688" I.D.	10,000	1" MEDIUM PRESSURE (LF16)	316 SS	10-9M16-316
	1" O.D. x 0.562" I.D.	20,000			20-9M16-316

## Nipples

Nipples are stocked in 316 stainless steel. Nipples in lengths other than those shown are supplied upon request. Nipples are not furnished with collars and glands, unless specified at time of order.

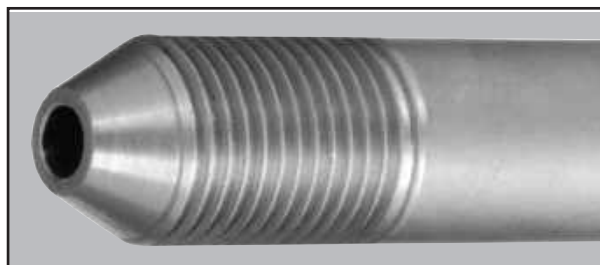

### Coned and Threaded Nipples

Length	Tubing Size (O.D. x I.D.)						
	$\frac{1}{4}$ " O.D. x $\frac{7}{64}$ " I.D.	$\frac{3}{8}$ " O.D. x $\frac{13}{64}$ " I.D.	$\frac{9}{16}$ " O.D. x $\frac{5}{16}$ " I.D.	$\frac{3}{4}$ " O.D. x $\frac{33}{64}$ " I.D.	$\frac{3}{4}$ " O.D. x $\frac{7}{16}$ " I.D.	1" O.D. x $\frac{11}{16}$ " I.D.	1" O.D. x $\frac{9}{16}$ " I.D.
psi	20,000 psi	20,000 psi	20,000 psi	10,000 psi	20,000 psi	10,000 psi	20,000 psi
$2\frac{3}{4}$ "	20-LM4-2.75						
3"		20-LM6-3					
4"			20-LM9-4	10-LM12-4			
6"	20-LM4-6	20-LM6-6	20-LM9-6	10-LM12-6	20-LM12-6	10-LM16-6	20-LM16-6
8"	20-LM4-8	20-LM6-8	20-LM9-8	10-LM12-8	20-LM12-8	10-LM16-8	20-LM16-8
10"	20-LM4-10	20-LM6-10	20-LM9-10	10-LM12-10	20-LM12-10	10-LM16-10	20-LM16-10
12"	20-LM4-12	20-LM6-12	20-LM9-12	10-LM12-12	20-LM12-12	10-LM16-12	20-LM16-12

# High Pressure Equipment

## Medium Pressure Connections (Coned and Threaded) 20,000 psi service

The Medium Pressure tubing connection is available for  $\frac{1}{4}$ ",  $\frac{3}{8}$ ",  $\frac{9}{16}$ "  $\frac{3}{4}$ ", and 1" O.D. tubing. The tubing may be prepared with the use of tooling (see tooling section 9.0) or prepared at the factory to specified lengths. Additionally, standard length coned and threaded nipples are available from stock (see page 3.9).

This connection has become an industry standard for use at elevated pressures and temperatures in both liquid and gas applications. It may be disassembled and retightened indefinitely.

The threads of the gland are right-hand while the threads of the collar and tubing are left-hand to prevent rotation of the collar during assembly.

### Materials.

All of the components required for make-up of a Medium Pressure connection (glands, collars and plugs) are produced in Type 316 stainless steel.

Glands and collars are provided with all valves and fittings (except nipples) unless otherwise requested. (See chart on the right for size details and catalog numbers).

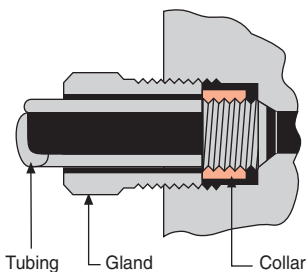

20,000 psi				
LF4 1/4" O.D. Tubing	LF6 3/8" O.D. Tubing	LF9 9/16" O.D. Tubing	LF12 3/4" O.D. Tubing	LF16 1" O.D. Tubing
<b>Female Opening Detail</b>				
<b>Gland</b>				
20-2LM4	20-2LM6	20-2LM9	20-2LM12	20-2LM16
<b>Collar</b>				
20-2L4	20-2L6	20-2L9	20-2L12	20-2L16
<b>Plug</b>				
20-7LM4	20-7LM6	20-7LM9	20-7LM12	20-7LM16
<b>Tube End Prep</b>				
LM4	LM6	LM9	LM12	LM16



# Contact Us

Tel: +44(0)191 549 7335

Email: [hos@hos.co.uk](mailto:hos@hos.co.uk)

Web: [www.hos.co.uk](http://www.hos.co.uk)



in

f

