

# Hydraulic & Offshore SUPPLIES

## Function of Fittings

Contact our team *and*  
**Order today on:**  
**+44 (0)191 549 7335**

Offshore House, Southwick Industrial Estate, Sunderland, SR5 3TX  
hos@hos.co.uk | [www.hos.co.uk](http://www.hos.co.uk)



**Index**

Ermeto Original tube fittings – introduction ..... A3

New Generation: High performance tube fittings..... A4

EO-Plus: Progressive Stop Ring PSR for steel fittings ..... A6

EO-DUR progressive ring DPR for stainless steel fittings ..... A8

EO2-Plus ..... A11

EO2-Form..... A15

EO Weld nipple..... A18

Introduction to O-Lok® ..... A20





Parflange® orbital flaring process and the Flange Seal system ..... A25

Introduction to Triple-Lok® ..... A28

Adapters – introduction ..... A32

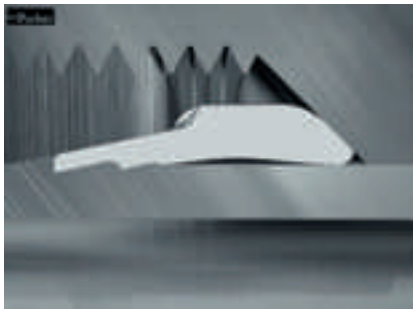
Thread configurations..... A36

## Ermeto Original tube fittings

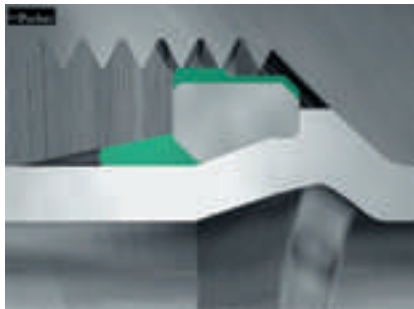
Metal sealing	Soft seal bite type	Soft seal tube forming
 	  <p data-bbox="710 952 885 996"><i>Dry Technology</i></p>	  <p data-bbox="1157 952 1332 996"><i>Dry Technology</i></p>

### Introduction:

The bite type fitting was designed by Ermeto in Germany in the early 1930's.

Ermeto-fittings soon became popular due to the simple assembly which basically just requires two wrenches. Today, the EO fitting is the most widely used bite-type fitting in the world.

EO fittings are designed for metric tube. All threads, hexagons, bores and other dimensions are purely metric. Historically it is based on German national standards 2353, DIN3861, DIN 3859 and DIN 2353, which today are represented in the international standards ISO 8434.

EO fittings are recognised for the high pressure performance from a compact body. EO fittings are available in the three series for low, medium and high pressures (LL, L and S-Series). This allows cost savings and -space minimised solutions for each specific application.



## Function of fittings



### New Generation: High performance tube fittings

The new, Cr(VI)-free fitting generation from Parker Ermeto is called EO-Plus for metallic sealed connections, EO2-Plus for Dry Technology systems and EO2-FORM for formed tube soft-sealed systems without cutting rings. The new generation is characterised by maximum safety even under extreme pressures of up to 800 bar nominal pressure.

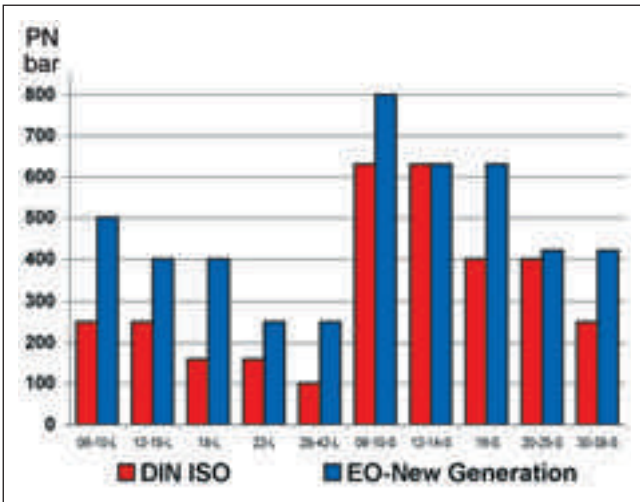

Nominal pressure ratings

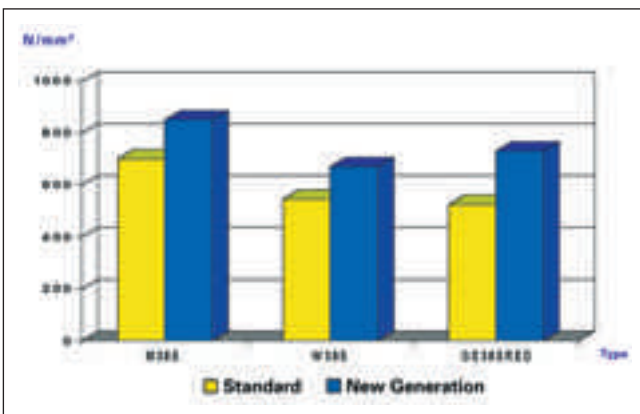

Material tensile strength

The new multifunctional PSR cutting ring, the heart of the EO-Plus fitting, ensures a uniquely simple and easy assembly through its multifunctional ring geometry.

The further development of the proven Dry Technology EO-2 concept is designated EO2-Plus and gives extremely high pressure ratings and greatly reduced tightening torques for the larger fitting sizes.

EO2-FORM is the new high pressure tube connection from Parker Ermeto. This concept unites the advantages of welded connections with those of EO-2 technology proven worldwide in millions of applications.

The New Generation from Parker Ermeto clearly exceeds the performance requirements of DIN/ISO standards: with its guaranteed 4-fold design factor, the new fitting generation can be used at the following nominal pressures in steel:

- Up to 500 bar in the L series
- Up to 800 bar in the S series
- A unique 420 bar in the 20 S–38 S sizes!

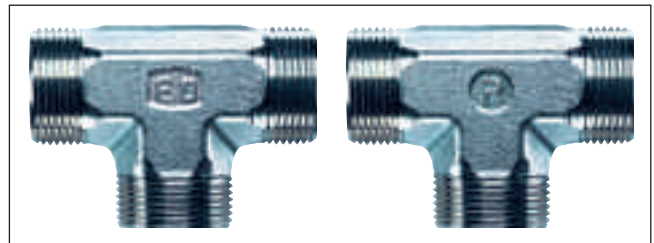

New forging design (front and back)

This extraordinary pressure and assembly performance can only be achieved by the use of even better and more resistant materials in combination with a special coating of individual components.

This greatly extends the application range and the user does not have to sacrifice any advantages. Thanks to the higher pressure levels, less expensive “L” series fittings can now be used instead of the heavier “S” series.

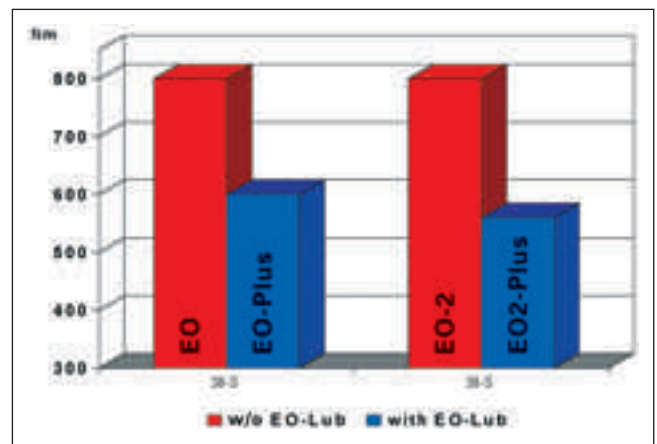

Assembly torques



The new high performance forging design with its considerably larger flats size makes assembly even safer and easier.

Through the application of a Cr(VI)-free surface treatment, Parker Ermeto meets future requirements of the automotive industry today, and respects the directive of the European Parliament to eliminate the use of Cr(VI). The removal of Cr(VI) reflects Parker's ongoing commitment to an environmentally clean and safe production process. The additional "Plus": the corrosion resistance is increased to more than 500 hrs. to white rust.

The EO-LUB procedure is yet another innovation unique to Parker. In addition to the standard dry wax lubrication of the tube nuts, all larger fittings (25S/28L and above) are EO-LUB treated. EO-LUB reduces the assembly torques by approximately 25%, which makes assembly easier and prevents underassembly, the most common reason for bite-type tube fitting failure.

This latest fitting generation benefits from Parker's long years of experience combined with continuous innovation. It is made with our state-of-the-art production methods, controlled by the strictest quality assurance systems and procedures.

## EO-Plus: Progressive Stop Ring PSR for steel fittings



### Introduction

The original fitting system used worldwide in millions of applications is now available in a new design: more safety even under the highest pressure, Cr(VI)-free surface treatment with significantly higher corrosion resistance, and considerably reduced tightening torques.

The ingenious invention of the cutting ring fitting was made by the founder of Parker Ermeto in the late nineteen twenties. In 1934, this idea was patented and today it is just as useful as it was on the very first day. Considering the range of applications, quality, reliability and functional safety, the principle of the Parker's cutting ring fitting has been a leading system up to today.

Of course, this has only been possible by continuously adapting the original invention from 1934 to the practical requirements of state of the art technology. Thus, the first Parker Ermeto cutting ring has little left in common with the latest multifunctional PSR cutting ring, the heart of EO-Plus.

The EO-Plus fitting meets the requirements of modern hydraulic systems. This is especially true for applications where the systems are exposed to extremely high loads.

EO-Plus is designed for metric tube and based on German Standards DIN 3861 and DIN 2353, which today are represented by the international standard ISO 8434-1. EO-Plus is available in "L"- and "S"-Series.

The PSR (Progressive Stop Ring) is available for the steel fitting range. For stainless steel applications, the Progressive ring DPR 71 is used and the Cutting ring for brass fittings and series LL.

### EO-Plus fitting features

The EO-Plus fitting produces high pressure, leak free connection of tubes and components in fluid systems. The basic function of EO-Plus is the controlled progressive bite of the PSR into the tube due to a unique internal geometry.

The front cutting edge A has already started cutting into the tube before the second cutting edge B begins. As soon as both cutting edges have cut into the tube to the designed depth further advance is limited by the stop shape C and the new overtightening protection D. Additionally, the special form of the PSR with its dimples at the front shoulder section gives an assembly state control.

Owing to the design of both cutting edges and stop shape all forces arising are equally distributed. This distribution along with the specially designed interior collar E of the ring guarantees increased safety, particularly with regard to vibration and flexure stresses. Service vibration loading is not present in the areas of the tubing where the bite is made.

The stop shape as well as the overtightening protection cause a clear sharp increase in tightening forces. After assembly, a visible collar F of cut tube material must completely fill the space in front of the first cutting edge. A slight bowing up of the ring G is desirable. This spring effect provides permanent compensation for flexural vibration and settling effects in the thread of the fitting nuts.

### Assembly

Assembly process is similar to EO-Progressive ring. See chapter E.

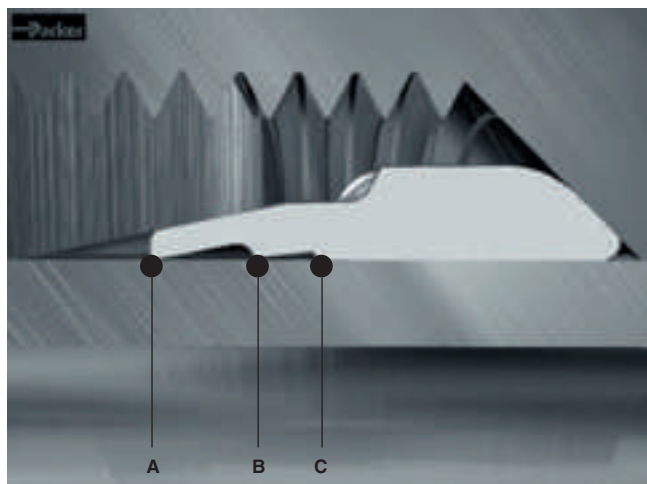

Before tightening the nut

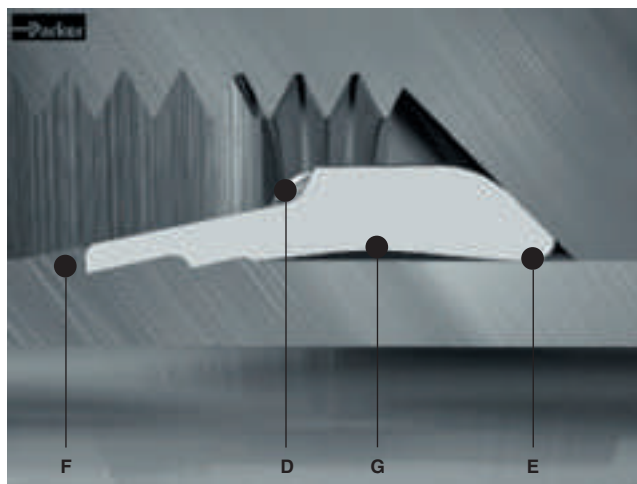

After tightening the nut

## Features, advantages and benefits of EO-Plus fittings

Naturally all advantages of the proven EO Progressive ring fittings are also present in EO-Plus, however, the new EO-Plus Generation additionally offers the following:

- **Plus: Highest corrosion resistance** – The corrosion resistance is increased to more than 500 hours to white rust.
- **Plus: Increased pressure** – Due to the application of even better materials combined with the special processing of individual components, EO-Plus can be used in applications of up to 800 bar (S series) and 500 bar (L series). EO-Plus considerably exceeds the DIN/ISO requirements and guarantees a 4-fold design factor. Thanks to the higher pressure levels, less expensive “L” series fittings can now be used instead of the heavier “S” series, which also is of benefit in limited or tight space applications.
- **Plus: EO-LUB** – Due to the special treatment of the larger sized nuts by the EO-LUB procedure (25S/28L and larger), the tightening torques of EO-Plus fittings have been reduced by 25%. This makes assembly easier and prevents underassembly, the most common reason for tube fitting failure.
- **Plus: Safe assembly** – Two distinctive cutting edges provide a progressive increase of the tightening torque of the PSR. The noticeable end point of assembly contributes to maximum safety of assembly, and the multifunctional ring geometry prevents over-tightening.
- **Plus: Overtightening protection** – The special geometry of the PSR prevents the overassembly of EO-Plus fittings.
- **Plus: Spring effect** – Thanks to the spring effect, re-tightening of the fitting is not necessary. Upon the completion of the assembly (due to the geometry, material and heat treatment) an elastic initial tension is achieved which compensates displacement effects in the thread and at the bite point of the tube.
- **Plus: Cr(VI)-free** – Due to its Cr(VI)-free treated surface, Parker Ermeto now meets the expected requirements of the automotive industry and the requirements issued by the European Parliament to eliminate the use of materials and surfaces containing Cr(VI). The removal of Cr(VI) reflects Parker’s ongoing commitment to an environmentally clean and safe production process.
- **Plus: Worldwide availability** – EO-Plus is available worldwide and meets the requirements of the applicable standards for 24° cutting ring fittings. The multifunctional PSR can be used with all types, series and dimensions of the wide range of EO-Plus fittings.



The new multifunctional PSR



Cranes – one of numerous applications for EO-Plus fittings

## EO-DUR Progressive Ring DPR for stainless steel fittings

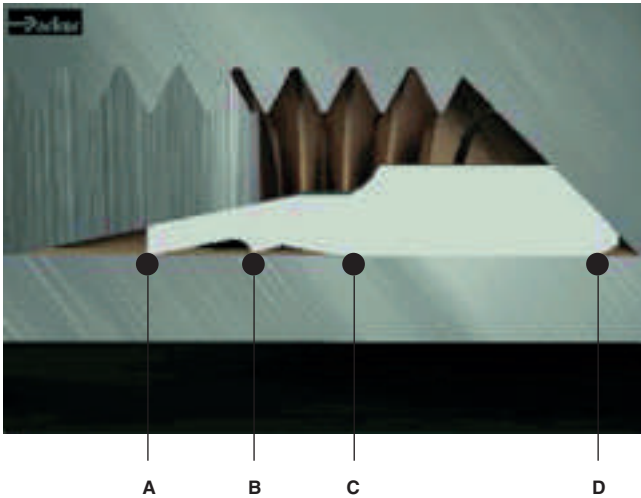

Before tightening the nut

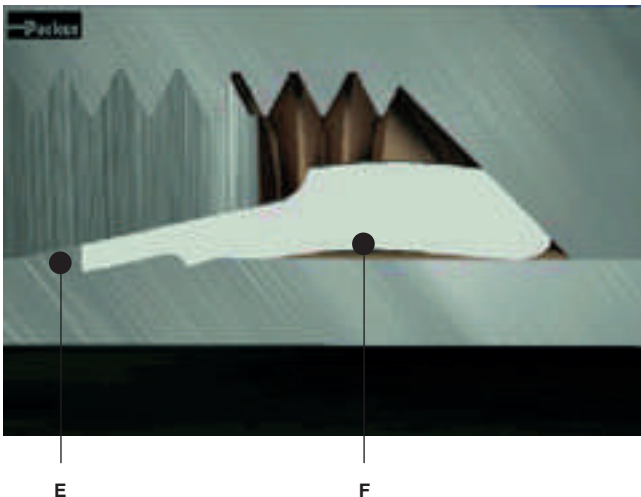

After tightening the nut

The proper assembly result is achieved by  $1\frac{1}{2}$  turns of the nut.

### The function of the EO-DUR stainless steel progressive ring fitting

The EO progressive ring fitting produces a low to high pressure, leak free connection of tubes and components in fluid systems. The basic function of the EO progressive ring is the controlled progressive bite of the ring into the tube due to its unique internal geometry. The design of the EO-DUR stainless steel progressive ring is based on three essential functions.

The front cutting edge (A) has already started cutting into the tube before the second cutting edge (B) starts. As soon as both cutting edges have cut into the tube to the designed depth further advance is limited by the stop shape (C).

Owing to the design of both cutting edges and stop shape all forces arising are equally distributed. This distribution

along with the specially designed interior collar (D) of the ring guarantees increased safety, particularly with regard to vibration and flexure stresses. The design and function of the cutting ring ensure that service vibration loading is not present in the areas of the tubing where the bite is made.

The stop shape causes a sharp increase in tightening forces which is perceptible. After assembly, a visible collar (E) of cut tube material must completely fill the space in front of the first cutting edge. With stainless steel tube and standpipe hose connections, the collar is smaller due to the harder material.

A slight bowing up of the ring (F) is desirable while this happens. This spring effect provides permanent compensation for flexural vibration and setting effects in the thread of the fitting nuts.

All EODUR stainless steel fittings show a special progressive ring design for best performance with stainless steel tubes. LL – series fittings and all brass fittings are equipped with a single bite “D”-ring.

### The spring effect

$$\textcircled{1} + \textcircled{2} + \textcircled{3} = 1\frac{1}{2} \text{ } \curvearrowright$$

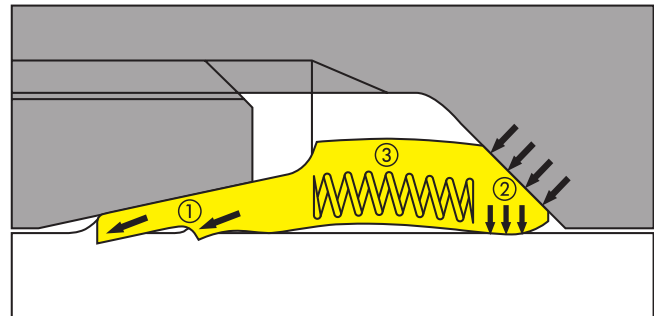

The 3 vital effects of Progressive-Ring assembly: sealing (1), tube clamping (2), spring effect (3).

During assembly of the EO progressive ring fitting, three essential functions are achieved:

#### ① Tube bite

The tube bite guarantees the leak free sealing and ensures the necessary holding power for high operating pressures. After assembly, a collar of cut tube material in front of the cutting edge is the visible control for the proper function of the connection.

#### ② Tube clamping

The rear section of the progressive ring is designed for clamping the tube firmly. This ensures that service vibration loading is not present in the tube bite area.



### ③ Spring effect

Towards the end of assembly, the special EO progressive ring design, material and heat treatment allow a defined elastic deformation of the ring. This spring effect compensates subsidences of tube bite and threads, thus ensuring long term leakfree performance without retightening.

### EO-DUR stainless steel products with silver plated threads

All threads of the EO-DUR stainless steel nuts are surface treated to reduce the tightening-torques by 40 % compared to non treated products. The treatment also avoids galling of the threads. Nuts larger than size 12S/15L are delivered with silver plated threads, all smaller sizes are treated with a special wax.

### The EO-DUR Suparcased SPH cutting ring

On the basis of the proven progressive ring design, the suparcased stainless steel bite-type ring has been developed especially for aggressive internal and external media. The special geometry and thermochemical hardening process guarantee a permanently leak-proof and corrosion-resistant connection under extreme conditions. Typical applications are in the food, chemical and medical industries as well as in process engineering.

### Common features, advantages and benefits of the EO Bite type system

- **Field assembly** – EO fittings can be assembled virtually anywhere with just a couple of wrenches. For stainless steel tube simple presetting tools are available. No additional equipment or machine is required.
- **Low cost assembly** – Using an EOMAT machine is the most economic method to preassemble EO rings onto tube ends. Whereas the actual preassembly process only takes some 1.4 seconds on the EOMAT, the total “floor-to-floor” time averages around 15 seconds.
- **3 series** – Very Light (LL), Light (L) and Heavy (S) series can be individually selected. For each application there is a solution for best flow rate, sufficient pressure resistance, smallest envelope size, low assembly force and minimum fitting cost.
- **Available sizes** – Most EO fittings are available in 25 sizes from 4 to 42 mm tube OD. Additional reducers allow optimum dimensioning of each individual fluid line. This saves space and material costs.
- **Tube wall** – EO fittings are suitable for use with light wall, medium wall, heavy wall, and extra heavy wall tubing. (Light wall tube may require support sleeve VH.)
- **Tube material** – EO-bite type fittings can be used with most tube materials, such as high and low-grade steel or stainless steel, copper, aluminium or CuNiFe. Even plastic tubes such as nylon, polyurethane, PVC or PTFE can be easily connected by using additional support sleeves E.
- **Visible bite** – The critical ring to tube front bite is clearly visible to tube fitters & inspectors. The presence of the recommended bite virtually eliminates any risk of catastrophic blow-off. This is a very important safety feature.
- **Reduced torque** – All nuts of EO-fittings are coated with a highly effective lubricant. Reduced assembly effort helps to prevent underassembly which is the most common reason for bite type fitting failure.
- **Sealing capability** – EO fittings have demonstrated a remarkable ability to remain leak free under various service conditions ranging from sealing high vacuum and small molecule gases to high pressure hydraulic fluids.
- **Distributed stresses** – Stresses due to flexural loading in service are distributed at several points in the joint, thus stress concentration in the bite is minimised.
- **Vibration control** – The rear bevel of the ring firmly grips tubing, thus dampening the effects of system vibration in the joint.
- **Envelope size** – EO fittings are comparatively small and compact, making them a suitable selection for tube connections in limited or tight spaces.
- **Temperature rating** – EO fittings are suitable for sub zero through elevated temperature applications. Service temperature rating is limited by the material chosen.

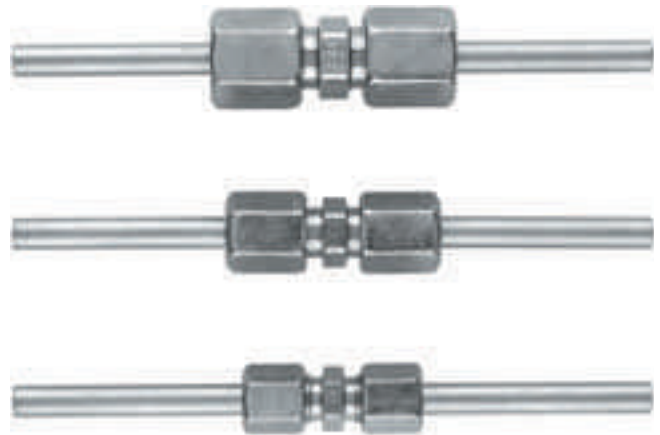

Top to bottom: EO Heavy (S), Light (L) and Very Light (LL) series:  
Best choice for each individual application  
(Illustration: Straight union 6 mm tube OD)

## Function of fittings

---

- **Compatibility** – Since EO fittings can be manufactured from a wide range of metals, compatibility factor with various fluids and atmospheric conditions is extensive.
- **Manufacture** – EO fittings are manufactured under tight quality controls which ensures that the product routinely satisfies or surpasses the requirements of the pertinent military and industrial standards. All manufacturing locations are ISO 9001 certified.
- **Silver plated nuts** – Stainless steel tube nuts are pre-lubricated with silver plated threads (size 15L-42L, 12S-38S). The threads of smaller sized stainless steel nuts are waxed. Thread galling is eliminated and assembly torque is reduced by as much as 40 percent. The EODUR treatment increases the speed and efficiency of stainless steel fitting assembly.
- **Tube length determination** – Exact tube length and bending can easily be checked by just trying out before assembly. This makes on-site piping very efficient.
- **Broad range of configurations** – EO fittings are available in more than 50 configurations. Especially for orientable fittings there is a wide variety of banjos, adjustable elbows or swivel combinations that allow an optimum solution for each application.
- **Functional fittings** – A variety of rotary fittings, non-return valves, Shut-off valves and test point connectors are available with the original EO-joint. This greatly reduces assembly time and cost of additional fittings and also eliminates possible leak paths.
- **True metric design** – EO fittings are designed to metric standards. All threads, hexagons, bores and other dimensions are purely metric.
- **No restrictions** – All bores of each fitting fit the inner diameter of the matching tube. LL, L and S-Series fittings are designed for best flow rate with thin, medium and heavy wall tube. Therefore, best performance without excessive noise or heat generation is always guaranteed.
- **World wide popularity** – The bite type fitting has worldwide acceptance. Most European, Asian, African and South American industry standards are purely metric. But also in Australia and Northern America DIN bite type fittings are gaining acceptance due to the metrification and end user specifications. Many machine operators prefer fittings that can be assembled without any additional equipment.

## EO2-Plus



### Introduction

As a part of Parker Ermeto's New Generation fittings, the Dry Technology EO-2 Plus Concept proven worldwide has been further developed. EO2-Plus means maximum pressure capability, as well as a new Cr(VI)-free surface with significantly higher corrosion resistance, and greatly reduced tightening torques for larger sized fittings.

The common feature of all EO2-Plus fittings is elastomeric seals on all joints. These are also now available in FKM for applications with higher temperatures or aggressive media. This assures leak free operation without retightening – even under extreme working conditions. The easy handling, time and cost saving features, and many assembly advantages of the unique EO2-Plus functional nuts have made EO2-Plus fittings increasingly popular.



EO-2: Safe dry – clean – leakfree

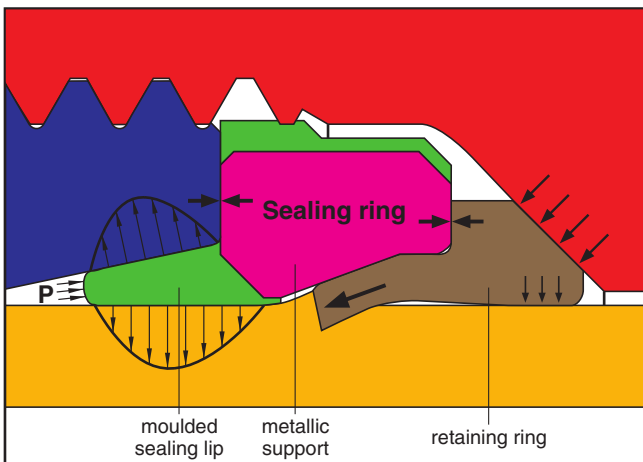

The metallic support of the sealing ring acts just like an integrated pre-assembly tool.

EO2-Plus is designed for metric tube and based on German Standards DIN 3861 and DIN 2353, which today are represented by the international standard ISO 8434-1. EO2-Plus is available in "LL", "L"- and "S"-Series.



The new Cr(VI)-free EO2-Plus Functional Nut: also with FKM sealing ring

### Features, advantages and benefits of EO2-Plus fittings

Naturally all advantages of the proven EO-2 soft sealed technology are also present in EO2-Plus, however, the new EO2-Plus Generation additionally offers the following:

- **Plus: Highest corrosion resistance** – The corrosion resistance is increased by 400 % to more than 500 hrs. to white rust.
- **Plus: Increased pressure** – Due to the application of even better materials combined with the special processing of individual components, EO2-Plus can be used in applications of up to 800 bar (S series) and 500 bar (L series). EO2-Plus considerably exceeds the DIN/ISO requirements and guarantees a 4-fold design factor. Thanks to the higher pressure levels, less expensive "L" series fittings can now be used instead of the heavier "S" series, which also is of benefit in limited or tight space applications.
- **Plus: EO-LUB** – Due to the special treatment of the larger sized nuts by the EO-LUB procedure (25S/28L and larger), the tightening torques of EO2-Plus fittings have been reduced by 25%. This makes assembly easier and prevents underassembly, the most common reason for tube fitting failure.
- **Plus: Cr(VI)-free** – Due to its Cr(VI)-free treated surface, Parker Ermeto now meets the requirements to be expected in the automotive industry and the expected requirements issued by the European Parliament to

## Function of fittings

eliminate the use of materials and surfaces containing Cr(VI). The removal of Cr(VI) reflects Parker's ongoing commitment to an environmentally clean and safe production process.

- **Plus: Worldwide availability** – EO2-Plus is available worldwide and meets the requirements of the applicable standards for 24° cutting ring fittings.

## Function of the EO2-Plus fitting system

### Elastomeric sealing

The elastomeric seal assures a hermetically sealed tube joint. It is located between the inner cone of the fitting body and the tube surface, thus blocking the only possible leak path. Due to its large cross-section, the seal effectively compensates for all manufacturing tolerances on tube and fitting cone.

The sealing effect is pressure supported which makes the EO2-Plus fitting suitable for high pressure applications. The static compression also eliminates air-ingress into the fluid system at vacuum conditions.

Elastomerically sealed EO2-Plus fittings do not require any retightening even in heavy duty applications. Seal extrusion is prevented by proper housing without gaps or dead volume. The sealing lip is bonded to a metallic support ring.

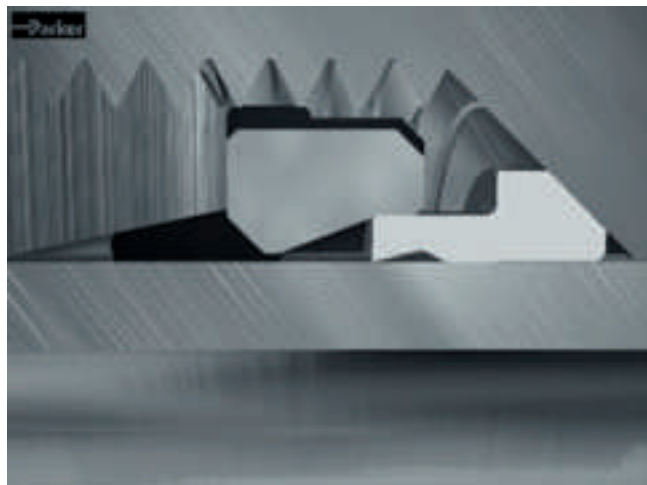

Before tightening the nut

### Assembly “to block”

The retaining ring bites into the tube in accordance to the proven bite ring principle. The support ring reduces the danger of over- or underassembly by a special EO2-Plus design feature: Before assembly there is a gap in between the flat surfaces of the retaining ring and the metallic support ring of the seal. As soon as the retaining ring has

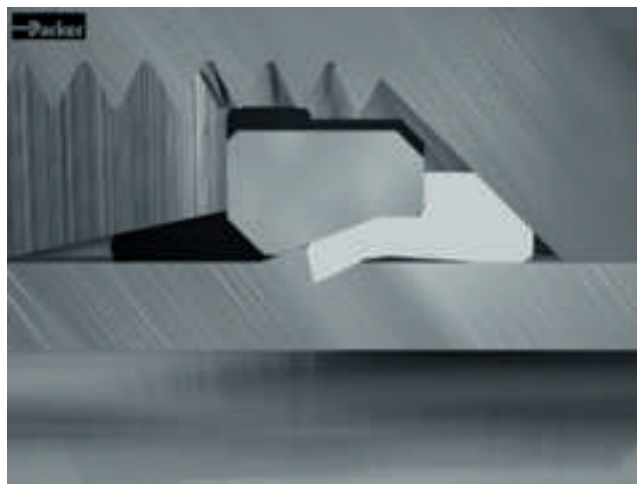

After tightening the nut

Closing the gap at the end of assembly provides a clear “Hit-Home-Feel”.

reached the proper bite depth, the gap closes, resulting in a sharp increase of assembly torque. This results in uniform and reliable fitting assemblies. The assembly result can easily be inspected by just checking if the gap is closed.

The separation of sealing and fixing function to two separate elements finally allows a more effective solution of the over- and undertightening problems of bite type fittings than increasing the number of cutting edges.

### Integrated assembly tool

The metallic support ring of the seal is made of a special design, material and heat-treatment to act as a assembly tool. This makes sure that the retaining ring securely cuts into the tube surface without damaging the sensitive inner cone of the fitting body.

This unique feature of EO2-Plus fittings even allows direct assembly of stainless steel tube without any additional pre-assembly process. An EOMAT machine can be used to allow easy assembly of large dimension tube and drastically save total assembly time, effort and costs.

The integrated assembly tool of EO2-Plus fittings even helps to save further costs and trouble when using an EOMAT-type presetting machine:

As the presetting cone is only in contact with the elastomeric sealing lip, it cannot be worn out or damaged even after thousands of assemblies. This does not only save replacement costs but also avoids leakage problems caused by worn presetting tools.

### The functional nut

The unique functional nut simplifies handling of fitting components and helps to minimise storage and procurement



The unique functional nut allows easy handling and quick assembly.

costs. The sealing and retaining rings are combined as a pair and are inserted into the internal thread of the nut in such a manner that they cannot fall out, so that these three parts form one functional element.

Individual components such as seals or retaining rings cannot be forgotten, confused or assembled in the wrong orientation. Time and cost is saved arranging the components to make up individual joints.

The functional nuts match all EO tube fitting joints. After assembly and disassembly, the sealing ring can be replaced individually without cutting off the tube end.

### Common features, advantages and benefits of the EO-2 and EO2-Plus fitting system

In addition to the general advantages of the EO tube fitting system, the unique EO2-Plus fitting features even more specific benefits:

- **Sealing capability** – An elastomeric seal forms the primary sealing element, thus assuring leakfree sealing. Even low-viscosity media such as water or gas are hermetically sealed. Hydraulic systems therefore do not “sweat” at fittings.
- **Durability** – The elastomeric seal does not require any retightening even after years of operation under extreme working conditions.
- **Bite control** – The ideal bite depth is controlled by the fitting design rather than by the fitters force. Closing the gap at the end of manual assembly, the fitter gets a clear signal that setting is completed and the joint is ready for inspection.
- **Functional nut** – Individual components such as the retaining ring or seal cannot be lost, forgotten, confused or assembled in the wrong orientation. This dramatically saves assembly cost and helps to avoid dangerous assembly errors.

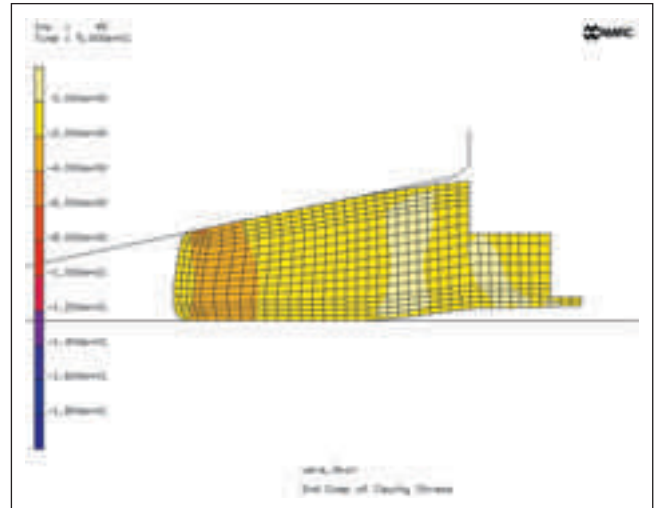

FEM (Finite Element Method) has been used to optimize the seal design (Picture: FES, Raiffeisenstr. 10a, D-74343 Sachsenheim).

- **Assembly cost** – With less than 10 seconds cycle time on the EOMAT (actual presetting process: 1.4 seconds) the cost of presetting EO2-Plus is extremely low.
- **Integrated preassembly tool** – Each EO2-Plus functional nut comes assembled with an integrated assembly tool that makes sure that the retaining ring securely cuts into the tube surface without damaging the sensitive inner cone of the fitting body. This greatly reduces the danger of tube blow-off, even when using stainless steel tube.
- **Reliable repeatability** – When EOMAT machines are used for cost-efficient presetting, the preassembly tools do not wear out as they are only in contact with the rubber seal. This avoids leaks and dangerous blow-off which can result when traditional bite-type fittings are assembled using worn presetting tools.
- **Final assembly** – From the wrench-tight position of the preset EO2-Plus joint, one short pull on the wrench (approx. 1/6 to 1/4 turn) gives the assembly a quick high rise to required torque. EO2-Plus fittings have a solid “Hit-home-feel” and excellent over-torque resistance.
- **Visible inspection** – There is no doubt if an EO2-Plus functional nut has been preset correctly or not. Inspection is as simple as checking if the gap between retaining ring and sealing ring is completely closed. The tube end does not have to be disassembled out of the fitting for bite inspection.
- **No phantom leaks** – Lubrication is not mandatory for the assembly of steel EO2-Plus fittings. The machine operator will not be irritated about lubricant coming out of the fittings once the hydraulic system gets hot.

## Function of fittings

- **Reusability/Remakeability** – EO2-Plus fittings can be disassembled and reassembled many times. There is no wear or widening of the vulnerable inner cone. Damaged seals can easily be replaced. All spare DOZ-seals are marked by size-code (e.g.: 12–L).
- **On-Site-Maintenance** – For the maintenance and replacement of EO2-Plus fittings a set of wrenches is sufficient. Additional in – line – components, such as test points (GMA), ball valves (KH) or Tee-fittings can be added to an existing assembly within minutes.
- **Interchangeability** – The EO2-Plus functional nut can be used for the whole variety of the broad range of more than 50 configurations in some 25 sizes of standard EO LL, L and S-series fittings. Changeover from progressive ring or weld nipple is easy by the simple use of EO2-Plus functional nuts.
- **Reliability** – Millions of EO2-Plus fittings are working trouble free in applications like: Mobile Construction equipment, stationary machine tools, hydraulic press-

es, plastic injection moulding machines, shipbuilding, offshore exploration, submarines, railway trains and military equipment. Leakage does not occur on EO2-Plus pipework.

- **Trouble-free** – Regular bite type fittings allow typical assembly-errors such as: confusion of bite type ring material and size. Also, the use of worn-out pre-assembly tool may result in fitting failure. The clever EO2-Plus design does not allow most of these mistakes without making the assembly process more complicated.
- **Popularity** – EO2-Plus fittings are as easy to assemble as traditional bite type fittings, but they eliminate most of their typical assembly problems. EO2-Plus fittings are therefore appreciated by an increasing number of original equipment manufactures. EO2-Plus also has become the fitting of choice of end-users that appreciate the leakfree performance, the easy maintenance and the global availability of the metric soft-seal bite type system.

## Suitable FM-type

	Steel tube	Stainless tube	Plastic tube
Steel fittings body (EO2-Plus)	FM...CF	FM...SSA	FM...CF
Stainless steel fitting body (EO-2)	—	FM...71	FM...71



EO-2 fittings are used for heavy-duty applications, such as construction equipment or plastic injection molding.

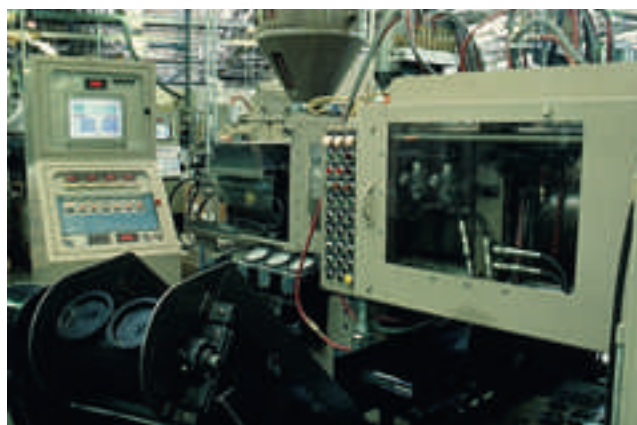

Every day millions of EO-2 fittings perform absolutely trouble-free.

## EO2-FORM

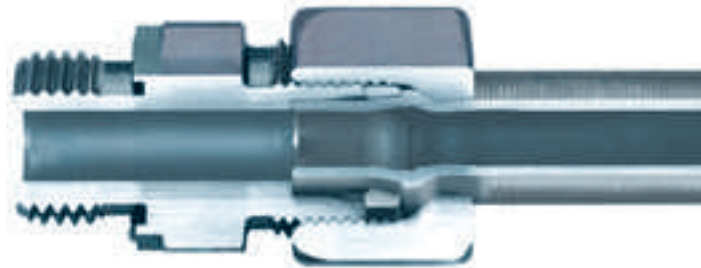

### Introduction

EO2-FORM is the new high pressure formed tube Generation of the Tube Fittings Division Europe. As with EO2-Plus, it is designed in to eliminate leakage in all fluid systems, by using elastomeric sealing systems.

The common feature of all EO2-FORM connections are the EO2 seal elements (Dry Technology) as well as the new cold forming process, that gives extreme rigidity and low tightening torques. The seals are now also available in FKM for applications with higher temperatures or aggressive media.

Through EO2-FORM, elastomeric sealing technology is made available even where bite-type connectors are not popular, like in hydraulic presses, cranes, lifts or ship canal locks. Compared to welding or brazing, the EO2-FORM process is faster and easier. It does not require special tube treatment, heating or chemicals.

EO2-FORM is designed for metric tube and fully interchangeable to the complete Ermeto Original product range according to ISO 8434-1 / DIN 2353. EO2-FORM is available in "L"- and "S"-Series.

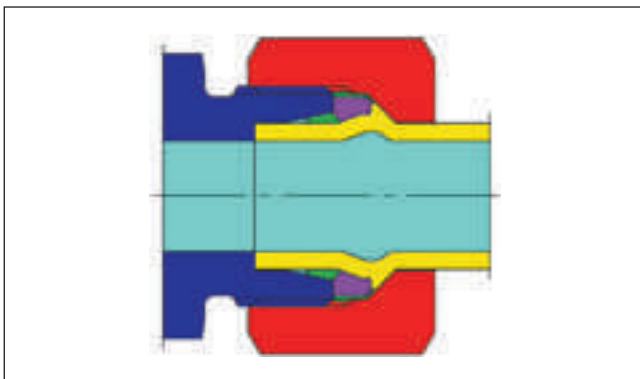

The new EO2-FORM connection:  
Extreme rigidity and low tightening torques



The EO2-FORM F3 machine

### Function of EO2-FORM

#### EO-2/EO2-FORM system

EO2-FORM is not a stand-alone product. It has been developed as an extension of the proven EO2-Plus system product range. All EO2-FORM components like nuts, seals and fitting bodies come from the EO2-Plus program. The only investment needed is the forming machine, which pays off quickly as it reduces assembly time and effort. Assembly characteristics of EO2-FORM are similar to

**The EO2-FORM process**



Tube end is prepared and equipped with EO nut

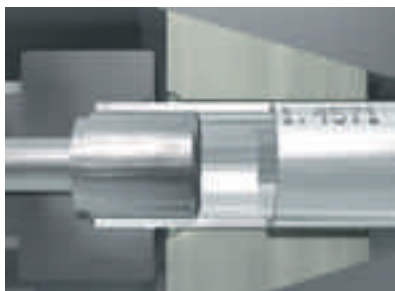

Tube is inserted into the tools until it firmly touches the stop at the end



After starting the process, the dies clamp the tube and the forming pin starts to move forward



While moving, the pin is continuously forming the tube wall and compressing the material



The tool shape defines the outer contour of the formed tube wall



The inner contour also gets slightly deformed but remains smooth and unrestricted for good flow characteristics



As soon as the moving pin touches the clamping jaws, the forming process is completed



The tube end is released and ready for attaching the EO-2 seal



Installation is made in the fitting body

EO2-Plus too. This allows the customer to use both products for his hydraulic pipework without increasing stock or confusing workflow engineers with new components.

**Elastomeric sealing**

For EO2-FORM, the same sealing ring “DOZ” is used as for EO2-Plus. The high volume elastomeric seal assures a hermetically sealed tube joint. It is located between the inner cone of the fitting body and the tube surface, thus blocking the only possible leak path. Due to its large cross section, the seal effectively compensates for all manufacturing tolerances between the tube and fitting cone.

The sealing effect is pressure supported which makes the EO2-FORM fitting ideal for high pressure applications. The static compression also eliminates air-ingress into the fluid system in vacuum conditions.

Elastomerically sealed EO2-FORM fittings do not require any retightening even in heavy-duty applications. Seal extrusion is prevented by proper housing without gaps or dead volume areas. The sealing lip is bonded to a metallic support ring.

**Cold-formed tube**

The cold-forming of the tube is carried out by the EO2-FORM machine. Machine operation and tool setup are optimised for short cycle times, which makes the process easy and fast. The tube is connected when the sealing ring is fixed and the nut is tightened.

The working contact area of the EO2-FORM connection is the flat front surface of the metallic support ring which is made of heat-treated, high-strength steel. This provides superior mechanical strength without settling, loosening or need for re-tightening.





Before tightening the nut

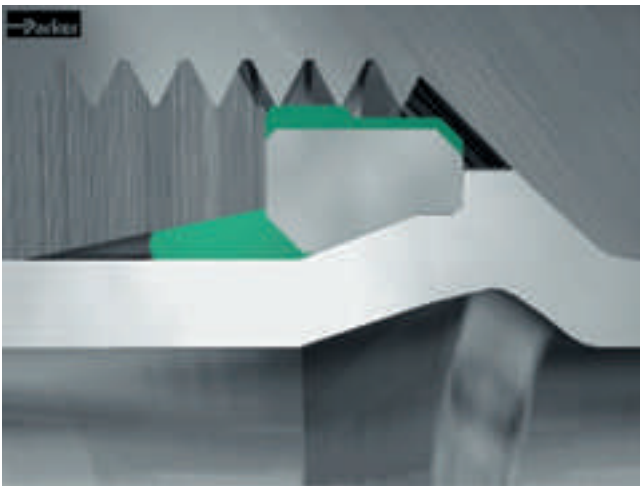

After tightening the nut

### Features, advantages and benefits of the EO2-FORM fitting system

- **System solution** – No additional items need to be purchased or stocked on top of the existing EO-2 product range. Assembly characteristics of EO-2-FORM are similar to EO-2-Plus. Therefore, EO2-FORM can be introduced with minimum effort.
- **Flexible concept** – The product family of EO-2 and EO2-FORM allows the application of the optimum product within a complex hydraulic system or a whole manufacturing facility. EO2-FORM can be used for heavy duty applications like presses, EO-2 is ideal for general hydraulic and pneumatic pipework. This allows maximum total system performance with minimum component, assembly and stocking cost.
- **No risk** – EO2-FORM technology is based on the proven EO-2 technology. All components and the assembly technology are approved. The customer does not have to test a new system.
- **Highest pressure performance** – Due to the application of even better materials combined with the special processing of individual components, EO2-FORM can be used in applications of up to 800 bar (S series) and 500 bar (L series). EO2-FORM considerably exceeds the DIN/ISO requirements and guarantees a 4-fold design factor. Thanks to the higher pressure levels, less expensive “L” series fittings can now be used instead of the heavier “S” series, which also is a benefit in limited or tight space applications.
- **Sealing capability** – The high volume elastomeric seal forms the primary sealing element, thus assuring leak-free sealing. Even low-viscosity media such as water or gas are hermetically sealed. Hydraulic systems therefore do not “sweat” at the fitting joints.
- **No phantom leaks** – Lubrication is not mandatory for the assembly of steel EO weld nipples. The machine operator will not be irritated about lubricant coming out of the fittings once the hydraulic system gets hot.
- **Universal** – The EO2-FORM machine can cold-form all common steel tubes used in hydraulic systems (the EO2-FORM process also allows the use of stainless steel and exotic materials such as CuNiFe; please ask for separate catalogue). EO2-FORM tools cover metric tube from 6 to 42 mm OD. Thin wall tube of 1 mm wall thickness can be formed, too.
- **Superior vibration resistance** – The new EO2-FORM process achieves a smooth structural transformation of the tube wall allowing superior vibration resistance.
- **Durability** – The elastomeric seal does not require any re-tightening even after years of operation under extreme working conditions.
- **Efficient** – Compared to welding or brazing, EO2-FORM is much less time consuming. Special tube preparation and finishing are not necessary. Forming uses only a fraction of the energy needed for brazing or welding.
- **Quality** – Tube clamping and tooling are fully automated. Therefore, high and consistent quality is achieved without manual adjustment.
- **Noise reduction** – Compared to other forming methods, the EO2-FORM process results in a smooth inner contour of the tube that does not allow the accumulation of air, dirt or other sources of trouble. Less pressure drop, heat and noise is created.
- **Re-usability** – EO2-FORM connections can be disassembled and reassembled many times. There is no wear or widening of the vulnerable fitting inner cone.
- **Approved** – Both, EO-2 high pressure tube fittings and the EO2-FORM process are tested and approved by independent organisations such as Germanischer Lloyd and Det Norske Veritas (DNV).
- **Small bending radii** – The compact clamping device and special dies are suitable for forming short tube ends.
- **Clean** – The EO2-FORM process is environmentally clean and safe. As no heat is used, hazards from chemicals, fumes or heat do not occur.

## EO weld nipple



The leakfree performance of EO Weld nipples is assured by an O-ring seal.

### Introduction

EO-weld nipples were introduced to the market in the late 60's. The simple bite rings off the 60's were designed for hydraulic applications of pre-war time and did not match growing market demands on high pressure performance, impulse and vibration resistance. Also, the single bite ring was easy to over- or undertighten. Most assembly workshops could not afford assembly machines so large size fittings often failed due to underassembly. European customers preferred to stay with the established EO fitting body range, as it provides unbeaten advantages like: full metric system, repair possible with just two wrenches and 3 series of different design and pressure performance.

EO weld nipples provide all these benefits based on replacing the bite type ring by a welded connection. Today, modern solutions like EO2-FORM and O-Lok® provide the same performance without the effort of welding.

### Applications

EO weld nipples are used for applications where the advantages of the EO program are appreciated and the rigidity of a solid weld connection is required. EO weld nipples are traditionally used for heavy duty applications such as hydraulic presses, mining, steel mills and shipbuilding.

Today, many users of weld nipples are switching to modern "Dry Technology" fittings using reliable assembly methods such as O-Lok®/Parflange® or EO-2/EOMAT.

### Function of the EO weld nipple

The wide EO fitting range allows welded tube connections. Therefore, the EO weld nipple has to be welded onto the tube end.

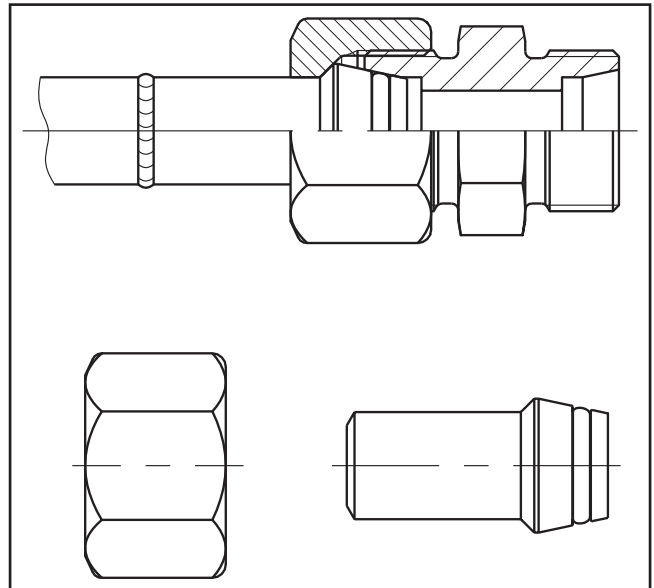

EO-Weld Nipples match to all fittings of the wide EO-range.

Using the standard EO nut, this weld nipple can then be connected to the tube joint of any EO tube fitting.

EO weld nipples are available for L and S-series tubes of 6–38/42 mm diameter. A broad range of weld nipple fittings including reducers or elbows covers most applications.

The use of EO weld nipples allows remakeable pipe systems based on rigid weld connections.

### Features, advantages and benefits of the EO weld nipple

EO weld nipples feature most advantages of the attractive EO fitting program. The specific benefits of the EO weld nipple program are:

- **Low quality tube** – Unlike bite-type or flared fittings, dimensional tolerances and rough tube surface are not very critical. Therefore weld nipples are suitable for countries where only poor quality tube is available.
- **Sealing capability** – An elastomeric seal forms the primary sealing element, thus assuring leakfree sealing. Even low-viscosity media such as water or gas are hermetically sealed. Hydraulic systems therefore do not "sweat" at fittings.
- **Durability** – The O-ring seal is assembled with a high initial compression. It does not require any retightening

even after years of operation under extreme working conditions.

- **Failure mode** – Unlike bite type fittings there is little danger of tube blow off if the fitting is not properly tightened. A loose joint shows excessive leakage before total failure.
- **Reusability/Remakeability** – EO weld nipples can be disassembled and reassembled many times. There is no wear or widening up of vulnerable inner fitting cone. Damaged O-rings can easily be replaced.
- **Smooth edge** – Under extreme working conditions, weld nipples are most likely to crack at the dimensional step just under the nut. In an additional rolling process this critical edge is smoothed for increased vibration strength.
- **Stress-free** – By welding, small deviations on tube cutting or bending can be compensated. Tension-free pipework is not likely to break even under extreme working conditions.
- **Welding process** – EO weld nipples are designed to be used for most popular welding processes.

## Function of fittings

### Introduction to O-Lok®



The O-Lok® fitting was developed by Parker Tube Fittings Division in the USA in the early 1980's. This product has proven to be extremely effective in eliminating leaks at the higher pressures found in today's hydraulic systems.

The O-Lok® fitting is an O-ring face seal (O.R.F.S.) type fitting that consists of a nut, a body, an O-ring and a sleeve. Parker O-Lok® fittings come standard with a trapezoidal seal "Trap Seal". As shown in Fig. 1 the tube is flanged to 90° using the patented Parflange® system (or the tube may be brazed instead to a braze-type sleeve). When the fitting is assembled, it compresses an elastomeric seal in the precision-machined groove in the fitting body to form a leak-free connection.

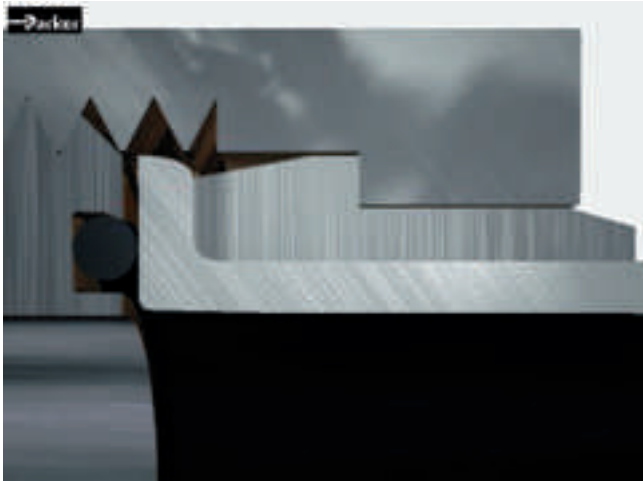

Before tightening the nut



After tightening the nut  
Standard O-Rings can be fitted instead of "Trap Seals"

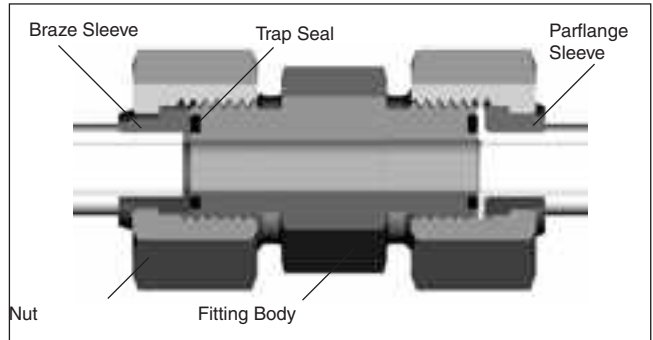

Fig. 1 – O-Lok® Union cutaway with brazed (LHS) and flanged assemblies

O-Lok® fittings are suitable for a wide range of tube wall thickness and are also readily adaptable to inch or metric tubing and hose connections.

### O-Lok® Progress

The last twenty years of experience supplying O-Lok® to the largest OEM customers have been well used in terms of listening to customer needs and refining design and material details to achieve the optimum mix of headline performance and a long trouble-free service life. After extensive product testing, it has been recognised that Parker O-Lok® fittings can be uprated to higher performance levels.

### O-Lok®

The O-Lok® fitting system is characterised by the words.

'Durability' and 'leakfree performance'.

- **Pressure Plus** – Larger fitting sizes nominal pressure increased
  - 20 from 280 to 420 bar\*
  - 24 from 280 to 350 bar\*

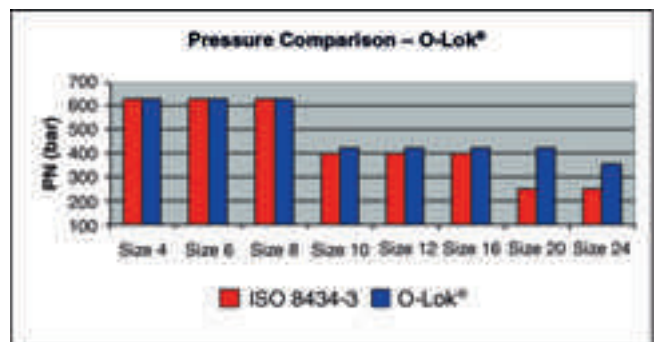

\*For detailed pressure ratings see chapter C.



- **Flange Seal Plus** – A development of the patented Parflange® system, the Flange Seal gives a cold-formed tube end connection to eliminate the need for costly brazing in Hose – Tube and Tube – Tube connections.
- **Plating Plus** – 120 hours resistance to white rust corrosion exceeds the requirements of international standards.
- **Cleanliness Plus** – Contamination is the biggest source of early component failure in hydraulic systems. Parker O-Lok® fittings meet all requirements from the factory to the point of use – backed up by individual bagging.
- **CORG Plus** – All Parker O-Lok® fittings are manufactured with the Captive O-Ring Grooves (CORG) as standard. (This is an optional version in ISO 8434-3 and SAE J1453). See fig. 2.
- **Range Plus** – Parker offers the widest range of catalogue standard materials, seal combinations, styles and sizes in the industry. Only Parker has all this.

## Introducing ACE Solutions

Advance Connector Enhancements are product features that take the fitting performance in the hands of customers beyond the standard we have come to expect. Driven by customer experiences and feedback from the field, ACE solutions are exactly that – simple engineering answers to real world problems.

### Trap Seal

The Trap Seal in Parker O-Lok fittings eliminates any possibility of the seal being rubbed out of position during the assembly process and hence cuts warranty costs and end customer dissatisfaction. Standard O-Rings can be dislodged without being noticed, leading to unexplained leaks after machines have been delivered to the end user. The simple patent pending engineered solution requires no changes in assembly method or order codes, and so is a seamless product upgrade unique to Parker. Existing standard O-Rings fit in the groove where necessary as field replacements.

### Robust Adjustable Port Fittings

Robust Adjustable Port connections have been developed and tested to prevent leaks caused by incorrect assembly procedures. The joint geometry is re-designed to stop the backup washer being deformed / damaged if the fitting is over tightened when threaded into the port. The new robust locknut eliminates the possibilities of excessive tightening damage. It is available for all parallel thread types – UNF, Metric, BSPP. The simple design improvement leaves the assembly instructions unchanged. Patent pending.



Fig 2 – Captive O-ring Groove (CORG) cutaway

### Cr(VI)-free Surface finish

In accordance with European “end of vehicle life” directive 2000/53/EC which becomes law on 1st July 2007, all O-Lok® products have Cr(VI)-free surface protection. The new surface – introduced as a running change – gives a minimum of 120 hours to first white rust as measured according to ISO 9227 / ASTM B117 5% NaCl solution test standards.

## Applications

The original development of the O-Lok® fitting was heavily influenced to meet the needs of international mobile equipment companies, mining, site clearance, agricultural and other heavy duty equipment. Today, the O-Lok® fitting is becoming an industry standard hydraulic fitting system for rugged duty equipment mounted on tracks or wheels. Equipment in these fields of application endure some of the highest levels of use, sometimes round the clock operation, in tough environments with extremes of temperature and mechanical stress. The simple, but effective design of the O-Lok® connection when used with the Parflange® tube preparation technology mean that long term ‘fit and forget’ performance is ensured, despite the physical conditions.

Simple, low torque assembly, no tube entry breakaway feature, 2”/50 mm max. tube size, and the ease of use with inch or metric tubing also make O-Lok® eminently suitable for general hydraulic applications in hydraulic presses, injection moulding equipment, shipbuilding, machine tools and a range of other areas. Anywhere in fact where a high quality leak-free tube or hose connection is needed.

### Function of O-Lok® fittings

The O-Lok® fitting consists of four main components: a body, sleeve trapezoidal elastomeric seal and nut.

#### The O-Lok® fitting body

There are over 40 different body configurations to choose from for specific applications. The body face has a groove, which contains a high durometer seal that is held captive during installation. In addition, the O-Lok® fitting body shapes are all forged for added strength and longer service life.

Straight fittings are made from cold drawn barstock. The cold drawing process ensures consistent dimensional tolerances, improved strength and consistent surface finish.

#### CORG Groove

O-Lok® fittings are manufactured with a Captive seal Groove (CORG) design for prevention of seal fall out prior to final assembly. The international standards for ORFS fittings contain two versions of the seal groove. The original design had straight sides and under certain conditions of tolerance between the seal and the groove, it was possible for the seal to be dislodged. As a further refinement of the O-Lok® fitting, Parker introduced the CORG groove as standard production in all its plants in 1998.

#### Elastomeric Sealing

From the design of the system, the Trap Seal compression gives excellent sealing characteristics from low pressure, low temperature circumstances found in winter during machine storage, to full pressure, high temperature cycles. Trap Seals are made from the same high quality NBR compound as the O-Rings superseded in 2006.

#### The O-Lok® fitting nut

Smaller size O-Lok® fitting nuts are cold-formed to provide a more tightly packed grain structure, resulting in a much stronger component. Larger size nuts are made of warm-forged steel-blanks.

#### The O-Lok® Parflange® sleeve

The preferred method of making an O-Lok® tube connection is by using the Parker Parflange® process to create the 90° flange on the tube end. A flange sleeve is used to support the flange and the tube, and provides the contact shoulder for the nut. After the Parflange® process, the sleeve is permanently fixed on the end of the tube reinforcing the joint.

The O-Lok® connection using the Parflange® method can be made with either metric or inch tubing by choosing the appropriate sleeves and tooling.

Parflange® sleeves from Parker are manufactured to exacting tolerances and geometry to work with the Parflange® machine and tooling, producing the robust, reinforced tube end connection. Failure to use the correct components can result in premature joint failure in the final application.

#### The O-Lok® braze sleeve

The braze sleeve provides the mating surface between the tube and the fitting body. Secondly, the braze sleeve, as the name implies, is attached to the tube through silver brazing. The braze provides holding power as well as a method to seal the joint. It also has a flat and smooth contact shoulder for the nut to connect the tube to the fitting body.

O-Lok® braze sleeves are manufactured to exacting dimensions. Tightly toleranced dimensions are required to prevent binding in the nut when torqued, to provide a flat and smooth sealing surface against the seal, and to give the appropriate clearance for silver brazing to the tube.

The O-Lok® connection can be made with either metric or inch tubing by choosing the appropriate braze sleeve.

#### The O-Lok® reducing braze sleeves

O-Lok® braze sleeves are manufactured in both even and reducing sizes. The reducing sleeves make it easy to adapt a larger face seal fitting to a smaller tube connection.

#### O-Lok® fitting function

The O-Lok® fitting body face contains a high durometer seal that is held captive in a precision machined groove. As the nut is tightened onto the fitting body, the seal is compressed between the body and flat face of the tube flange or braze sleeve to form a tight, positive seal.

As the two faces come in contact, further tightening of the nut produces a sharp rise in assembly torque. A solid pull of the wrench at this point, to the recommended assembly torque, completes the assembly.

The sharp torque rise gives a "solid feel" at assembly, and minimises the possibility of over tightening.

Because the sealing surfaces are flat and perpendicular to the assembly forces, they remain virtually free of distortion during assembly, giving O-Lok® fittings virtually unlimited remakeability. The seal should be inspected at each disassembly and replaced when necessary.

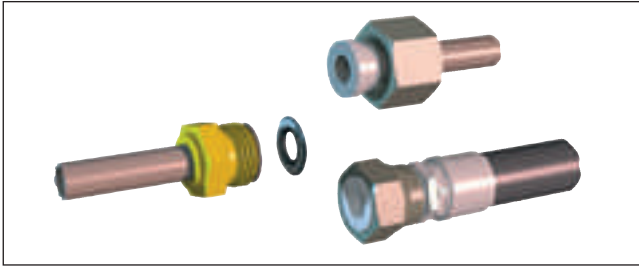

Flange-Seal fitting system

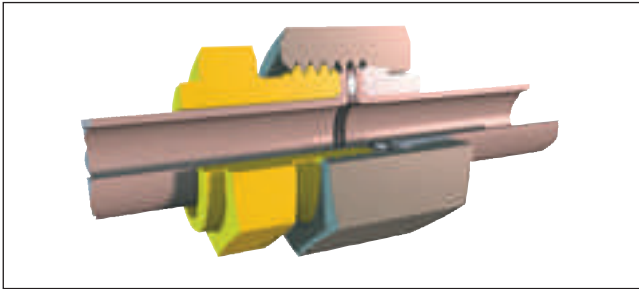

Dry Technology connection

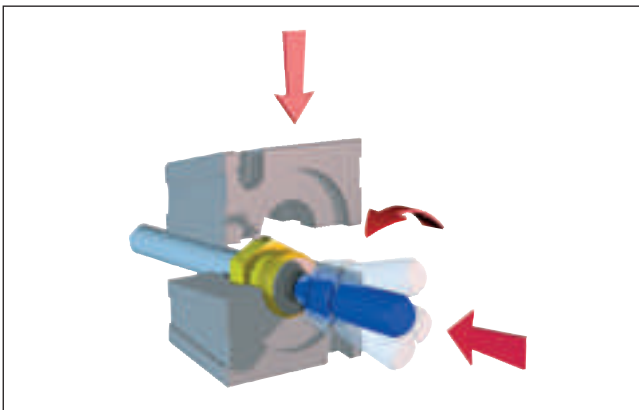

Orbital flanging

## The Flange Seal System

Parker's new Flange Seal Fitting System, provides an efficient, fast, and economical method to connect a tube line to a hose assembly, or another tube line. It replaces the need for conventional braze-on male ORFS ends by a modern tube preparation method. By eliminating the brazing operation, this creates several advantages – flexibility of batch sizes, and production location, safer finished result, fewer process stages, all resulting in cost reduction opportunities.

The Flange Seal System is a development of the patented and proven Parflange® process to create a 90° flange on the tube end. A custom-designed bonded elastomeric seal is positioned between the Flange Seal tube line and the mating hose/tube assembly. The seal is designed with rubber tabs on the outside diameter, allowing it to be securely positioned within the tube nut or hose end swivel prior to assembly. When assembled by tightening the nut, the seal

is compressed between the two flat surfaces, providing a leak-tight connection.

## Flange Seal features, advantages and benefits

- Eliminates potential leak path and reduces costs
- Reduced assembly costs
- Leak free connection, lower assembly and rework costs
- Assures reliable sealing
- Reduced tube preparation cost
- Flexible, reduced batch sizes, lower stock costs
- Safer process
- Reduced cost and complexity
- Better asset utilisation

## O-Lok®

### Features, advantages and benefits

- **Leak-free** – The O-Lok® fitting system provides a leak-free, 'fit and forget' performance due to the elastomeric sealing design. O-Lok® fittings form part of Tube Fitting Division's 'Dry Technology' family of products.
- **Pressure rating** – With pressure ratings up to 630 bar, the O-Lok® system meets the requirements of today's high pressure hydraulic systems.
- **Heavy duty capability** – In addition to high pressure resistance, O-Lok® fittings have been tested and proven in the heaviest duty applications known against the effects of shock and vibration, and are becoming the 'fitting of choice' in construction equipment.
- **Trap Seal** – Prevents seal rub out, hence reduces warranty costs from leaks in the field. Replaceable with standard O-Rings for convenience.
- **Robust Adjustable Port Connections** – Eliminates potential assembly errors associated with over tightening of the elbow or tee bodies into ports. Reduces warranty claims from unseen assembly faults.
- **Cr(VI)-free surface** – O-Lok® fittings conform to the requirements of the European directive 2000/53/EC.
- **Corrosion resistance** – O-Lok® fittings achieve a minimum of 120 hours to first white rust, exceeding industry standards.
- **Flexibility** – O-Lok® is available in steel, stainless steel and brass (on request). By selecting body materials and changing industry standard sized O-rings, the O-Lok® system can adapt to the extremes of temperatures and specified fluid media.

## Function of fittings

---

- **Hose or tube connections** – O-Lok® fittings can be used equally well as a tube fitting or a high performance hose adapter.
- **Ease of tube preparation** – The patented Parflange® tube preparation system flanges the tube end to 90 degrees to give a high quality seal face against the fitting TRAP seal.
- **Ease of tube preparation** – the new Flange Seal system allows the elimination of costly brazing for hose – tube and tube – tube connections.
- **Tube materials** – O-Lok® fittings can be used with most tube materials, such as high and low-grade steel or stainless steel, copper and aluminium.
- **Metric or inch tube compatibility** – Just by changing the tube sleeve, either inch or metric O.D. tube can be used. Customer tube specifications can be followed without changing the complete fitting system. O-Lok® is one of the few designs of tube fitting to allow this.
- **Range of standard sizes** – the O-Lok® system is available in sizes to suit from 6 mm/1/4" to 50 mm/2" tubes, or their equivalent hose sizes. No other manufacturer makes this range as standard.
- **Ease of assembly** – Because the system design requires no component deformation or tube forming during the final assembly, the O-Lok® fitting is exceptionally easy to assemble, requiring lower assembly torque than comparable fittings of similar working pressure.
- **Over torque capability** – Parker O-Lok® tube fittings are capable of withstanding up to twice the recommended assembly torque without damage or failure.
- **Consistency of assembly** – At final assembly, metallic faces are in direct contact, giving a clear signal to the assembler. After this point, a short sharp pull is all that is needed to complete the joint. This short assembly tightening angle means that fittings are much easier to assemble in areas with poor access or little space.
- **Visible quality check** – Due to the design, quality checking prior to final assembly is simple and therefore reliable.
- **No tube entry** – O-Lok® fittings and the corresponding tube end both have a flat face. This means that tube lines can be more easily installed without 'springing', and during maintenance, it is easier to disassemble hydraulic components without completely stripping the line.
- **Breadth of fitting styles** – O-Lok® is available as standard in over forty basic fitting body styles, making it a flexible system.
- **Worldwide availability** – O-Lok® fittings are available worldwide from the Parker network of sales locations and Certified Distributors, giving back-up wherever it is needed.
- **Standardised** – Parker O-Lok® fittings conform to the relevant international standards (SAE J1453 & ISO8434-3), which means that specification of the fitting system is easy, consistent and low cost compared to writing 'in-house' standards.



## Parflange® orbital flaring process and the Flange Seal system

### The Parflange® process

With the Parflange® process, the tube to sleeve attachment is achieved mechanically during an orbital cold forming process with a Parflange® machine. The process progressively flares then flanges the tube. The final dwell action in the cycle ensures that the seal surface produced is smooth and flat, and also eliminates springback effects in the material. This flange provides both the holding power and sealing surface (eliminating the braze joint, and hence, a potential leak path found with brazed sleeve attachment). The only sealing point is between the fitting body and the tube flange face via the high durometer elastomeric seal. Trap Seals are now fitted as standard to Parker O-Lok® fittings.

The flanging process is very fast and requires very little cleaning prior to or after flanging. Thus, the process enhances the integrity of the joint and reduces cost.



Parflange® 1025

The Parflange® process utilises an orbital cold flow forming process to produce a flat, smooth, rigidly supported 90° sealing surface on the tube end. The process progressively flares then flanges the tube.

The Parflange® process conforms to the requirements for mechanical tube forming shown in the SAE J1453 standard, and has been specified after extensive testing by the majority of the large mobile equipment manufacturers.



Upgraded Parflange® 1050 – Easier to use, reliable machine

Flanging with Parflange® eliminates the need for welding or brazing of the sleeve to the tube end.

### New 1050 Parflange® series production machine

The 1050 generation of the hugely successful Parflange® machine incorporates all the feedback and suggestions from professional tube manipulation users across the world. Ergonomics, controls and electronics and maintenance aspects are all improved, but the heart of the process – the Parflange® orbital forming head remains unchanged. Similarly existing tooling can be used with the new machine, making a 1050 upgrade from the 1040 generation a seamless experience. For full details please see chapter H.

### Parflange® advantages over brazing or welding

- **Flexibility** – Fast tool changes and easy set-up make small batches economical to reduce WIP (work in progress) and inventory costs.

## Function of fittings



Parflange® tools

- **Faster** – 9 to 12 times the speed of comparable induction brazing.
- **Simple tube preparation** – The Parflange® process does not require any special pre- or post-flange cleaning of the tube and sleeve. The process is simple and the machine requires straightforward training only to operate.
- **Safety** – Unlike brazing, the Parflange® process does not require any flux, braze alloy, post braze cleaner or rust inhibitor. An environmentally safe lubricant applied to the flanging pin is the only additive associated with the Parflange®.

### The Parflange® process



For O-Lok®, the sleeve is placed into clamping dies first



Tube is inserted into the tools until it firmly touches the stop at the end



After starting the process, the dies clamp the tube and the flanging pin starts the orbital movement and the forward stroke



While moving, the front pin expands the tube wall from the inside



As soon as the flat working surface of the pin contacts the tube end, the flanging process begins



The front surface is continuously rolled and compressed. From the inside, the tube surface is slightly expanded to clamp the sleeve



As soon as the defined flange contour is achieved, the orbital movement stops and the pin withdraws



The tube end is released and can be taken out of the machine



The connection is ready for assembly

- **Environment** – The Parflange® process is environmentally clean and safe. It does not require open flame or any form of heating. Additionally, there is no emission of hazardous fumes, as is typical with welding and brazing.
- **Energy** – The Parflange® process uses only a fraction of the energy needed for welding or brazing.
- **Corrosion resistance** – The Parflange® process accommodates the use of plated or unplated components (i.e. tube and sleeve). Thus, the high costs of electroplating assemblies after fabrication is eliminated by using pre-plated tube.
- **Excellent surface quality** – The Parflange® process eliminates the potential leak path present at the braze or weld joint. The Parflange® process produces a burnished sealing surface, typically much smoother than the 3.1 µm/125 micro-inch Ra surface smoothness requirement of SAE J1453.

Users of Parflange® and Parker's O-Lok® fittings enjoy all the inherent sealing, reliability, time and cost saving benefits, without the many drawbacks which accompany welding or brazing.

Therefore, Parker strongly recommends the Parflange® process for the assembly of Triple-Lok® and O-Lok® connections. Parflange® machines range from desktop 1025 for flexible workshop use to 1050 for economic industrial production.

## Features, advantages and benefits of the Parflange® process for Triple-Lok®, O-Lok® and Flange Seal connections

- **Superior sealing performance** – The patented Parflange® process achieves a sealing surface of unique surface quality and mechanical strength.
- **Superior vibration resistance** – Unlike conventional flaring, the Parflange® process results in a rigid connection of the O-Lok® sleeve on the tube-end. Parflange®/O-Lok® connections perform much better under reversed bending stress conditions.
- **Easy to use** – No programming or adjustments necessary. High quality results are consistently achieved without manual adjustment.
- **Cost saving** – Compared to brazing or welding, orbital flanging is much less time consuming. Special tube preparation and finishing are not necessary. Flanging uses only a fraction of the energy needed for brazing or welding. In summary the Parflange® process can reduce costs for volume manufacture by more than half.
- **Clean** – The Parflange® process is environmental clean and safe. As no heat or chemicals are used, hazards from fumes or heat do not occur.
- **Zinc plated tubing** – The Parflange® process allows the use of zinc-plated tubing. The cost for cleaning, post process plating or painting can be saved.
- **Process/Product concept** – Parflange® machines are specially designed to match Parker O-Lok® and Triple-Lok® standards. Machine, tools and products are fine-tuned for reliable performance.
- **Proven technology** – For more than 14 years, hundreds of Parflange® machines have operated worldwide under heavy duty workshop conditions.

### Introduction to Triple-Lok®



The concept of flaring tube to provide a seal and holding power to the connection is very old. Its origin goes back to the early days of the automobile. Different types of flared connections including 45° single and double flares, inverted flare, 30° flare, etc., were developed for coolant, fuel, brake and lube systems of the early automobile.

Pioneered by Parker Hannifin, the Triple-Lok® 37° flared fitting evolved as a higher pressure version of the above connections. Its initial use was in the developing hydraulic systems of agricultural and earth moving machinery, automotive transfer lines and other machine tools.

As exports of machinery increased after World War II, the Triple-Lok® Plus fitting gained worldwide use and acceptance. Today it is the most widely used fitting in the world.



Before tightening the nut



After tightening the nut

It enjoys conformance approvals by a range of national and international technical and certifying organisations.

Its appeal is in its simplicity, compact design, ease of assembly, reliability (single sealing point), wide availability and acceptance. It is especially suited for low and medium wall thickness tubing. Today the Triple-Lok® generation capabilities range from 500 bar for smaller sizes to 140 bar for largest – 2” size. Currently it is used in virtually every application that uses fluid power for motion control.

### Triple-Lok® Progress

Parker have supplied more Triple-Lok® fittings than any other manufacturer over the last seventy years. Parker engineers take a leading position in advising both customers and the international standards committees concerning 37° flare fittings. This experience, combined with optimised manufacturing methods and materials have resulted in steady product performance improvements verified by extensive testing in the laboratory. A combination of simple burst tests (with a 4× design factor), impulse and vibration tests have shown Parker Triple-Lok® fittings can be uprated to higher performance levels in the smaller and in the larger sized parts. Additionally, the corrosion protection level has been improved by 100% due to effective process control.

### Triple-Lok®

The Triple-Lok® fitting can be characterised by the phrase “reliable product performance”.

- **Pressure Plus** – Following fitting sizes nominal pressure increased
  - Size 4: 350 ISO 8434-2 (bar) 500 Triple-Lok® (bar)
  - Size 5: 350 ISO 8434-2 (bar) 420 Triple-Lok® (bar)
  - Size 6: 350 ISO 8434-2 (bar) 420 Triple-Lok® (bar)
  - Size 8: 350 ISO 8434-2 (bar) 420 Triple-Lok® (bar)
  - Size 20: 210 ISO 8434-2 (bar) 280 Triple-Lok® (bar)
  - Size 24: 140 ISO 8434-2 (bar) 210 Triple-Lok® (bar)
  - Size 32: 105 ISO 8434-2 (bar) 140 Triple-Lok® (bar)

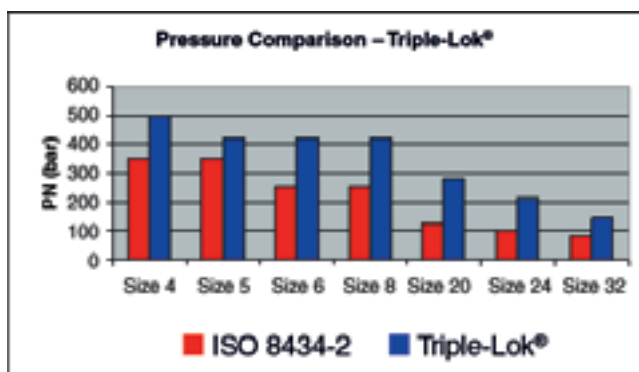



Fig. C1 – Assembled Triple-Lok® fitting cutaway and Triple-Lok® fitting components (fitting body with O-ring, sleeve and nut).

- **Plating Plus** – 120 hours resistance to white rust corrosion exceeds the requirements of international standards.
- **Cleanliness Plus** – Contamination is the biggest source of early component failure in hydraulic systems. Parker Triple-Lok® fittings meet all requirements from the factory to the point of use – backed up by individual bagging.
- **Range Plus** – Parker offers the widest range of catalogue standard materials, seal combinations, styles and sizes in the industry. Only Parker has all this.

This all adds up to an unbeatable combination of performance and customer-friendly features.

## Introducing ACE Solutions

Advance Connector Enhancements are product features that take the fitting performance in the hands of customers beyond the standard we have come to expect. Driven by customer experiences and feedback from the field, ACE solutions are exactly that – simple engineering answers to real world problems.

### ● Robust Adjustable Port Fittings

Robust Adjustable Port connections have been developed and tested to prevent leaks caused by incorrect assembly procedures. The joint geometry is re-designed to stop the backup washer being deformed / damaged if the fitting is over tightened when threaded into the port. The new robust locknut eliminates the possibilities of excessive tightening damage. It is available for all parallel thread types – UNF, Metric, BSPP. The simple design improvement leaves the assembly instructions unchanged. Patent pending.

### ● Cr(VI)-free Surface finish

In accordance with European “end of vehicle life” direc-



tive 2000/53/EC which becomes law on 1st July 2007, all Triple-Lok® products have Cr(VI)-free surface protection. The new surface – introduced as a running change – gives a minimum of 120 hours to first white rust as measured according to ISO 9227 / ASTM B117 5% NaCl solution test standards.

### ● Dual Angle Swivel Connections

In another ‘first’ for Parker, all swivel female cone connections will be switched to the unique dual angle design. This will make the connections even more effective by increasing the reliability in dynamic pressure conditions, making the contact point between the cones more stable, and easier to make a tight connection when the sealing cone gets damaged. Further, the pressure rating for some of the connections will be increased, without the need for heavier or higher strength materials. Another elegant engineering upgrade from Parker. There are no changes to the assembly procedures or part numbers. Customers need do nothing to start to receive a superior product.

## Applications

Because of its long history and the heavy influence of American industry worldwide, Triple-Lok® fittings designed to the original American SAE standard are found in almost every branch of hydraulics, from garbage trucks to ship-building. They are particularly prevalent in those branches of mobile hydraulics where medium pressure systems are used. The Triple-Lok® fitting system is especially applicable where high volumes of tubes are prepared, and efficient tube flaring equipment can be employed. Still field repairs can be made with hand tools where needed.

## Function of Triple-Lok® fittings

The Triple-Lok® fitting design is very simple. It uses an easily produced flare at the tube end to seal and hold fluid under high pressure. The fitting consists of three pieces: the body, sleeve and nut. The tube end is flared to a 37° angle and held between the fitting nose (seat) and the sleeve (support) with the nut as shown in Fig. C1, provid-

## Function of fittings

---

ing a very effective single seal point between the fitting nose and the tube flare.

The support sleeve serves several important functions:

- It provides a clamping surface against the rear of the tube flare and a bearing shoulder for the nut. This minimises tube twisting during assembly.
- It provides support to the tube flare. The tapered fitting nose tends to wedge open the flare during assembly. The sleeve helps to resist this expansion, allowing the fitting to be tightened adequately.
- It makes the fitting adaptable to both metric and inch O.D. tubing merely by changing the sleeve. This feature has made Triple-Lok® fittings accepted worldwide.

The Triple-Lok® design is also very efficient. It has the smallest seal area of all fitting designs. The seal area is only slightly larger than the fluid flow area. The small seal area results in compactness and low assembly torque compared to the holding power of the joint.

The design was standardised initially as a J.I.C. (Joint Industrial Council) design and was later adopted by the S.A.E. (Society of Automotive Engineers) and I.S.O. (International Organisation for Standardisation) to assure complete dimensional interchangeability between various manufacturers.

Even though many manufacturers conform to the same dimensional standard, there are significant differences in actual performance of the fittings because of a variety of methods of manufacture and quality standards used.

Triple-Lok® fitting components are produced using the best methods of manufacture and state of the art equipment to assure construction integrity, high strength, long service life and high quality.

**The Triple-Lok® body** – Straight bodies are made from either cold drawn bar stock, or cold-formed construction. All shapes are of one-piece forged construction eliminating potential leak paths of multiple component constructions such as brazed shapes. The Triple-Lok® steel forged shapes also feature higher hardness for high pressure capability and minimising nose collapse (typical of sizes – 10 and under) during repeated assembly. This compares very favourably to parts of brazed construction, which typically exhibit lower hardness and hence much more nose deformation.

**The Triple-Lok® sleeve** – Triple-Lok® fitting support sleeves are cold-formed and heat treated for an optimum combination of strength and ductility. Cold forming also eliminates the problems of laps, folds, stringers, etc., associated with sleeves machined from bar stock.

**The Triple-Lok® nut** – Nuts for all but the three largest sizes (–20, –24 and –32) are cold formed. Cold forming increases material strength and its fatigue properties, imparting high strength and longer service life to the nuts.

Larger nuts which are less severely stressed, are hot forged.

### Triple-Lok® fittings sealing function

As seen in Fig. C2, tightening of the nut clamps the tube flare against the body nose, producing a leak tight joint. This clamping onto the 37° cone provides a measure of elasticity to the joint helping it to resist loosening under vibration. The clamping force results in a radial load ( $F_R$ ) that tends to deform the fitting nose inwards. The resistance of the nose to elastic deformation provides a constant pre-load (similar to a spring washer) keeping it tight.

The clamping force provided by the nut resists the opposing force of the fluid under pressure. The joint remains leak tight as long as the clamping force is higher than the opposing pressure load. Properly assembled Triple-Lok® fittings with appropriate tube will seal consistently under pressure until the tube bursts.

Sealing in Triple-Lok® fittings takes place between two smooth metal surfaces, the fitting nose and inside of the tube flare. Therefore, the sealing surfaces have to be round and smooth, free of any, scratches, dents, spiral tool marks, splits or weld beads, in the seal area.

Seamless or welded and redrawn fully annealed tubing is recommended for Triple-Lok® fittings for ease of flaring and tube bending.

### Features, advantages and benefits

- **Pressure** – Triple-Lok® fittings are rated up to 500 bar nominal pressure with 4× design factor. Triple-Lok® can be used in more applications.
- **Robust Adjustable Port connections** – Eliminates potential assembly errors associated with over tightening of the elbow or tee bodies into ports. Reduces warranty claims from unseen assembly faults.
- **Cr(VI)-free surface** – O-Lok fittings conform to the requirements of the European directive 2999/53/EC.
- **Corrosion resistance** – Triple-Lok® fittings achieve a minimum of 120 hours to first white rust, exceeding industry standards.
- **Dual Anlge Swivel** – improved reliability in dynamic pressure conditions and increased pressure ratings for the swivel connection.

- **Safety** – The flared tube provides a solid and visible stop for the nut. The tube flare means there is no risk of tear out of the tube, thus giving the Triple-Lok® system a reputation for safety.
- **Single seal point** – Triple-Lok® fittings have only one seal (between the fitting nose and flare I.D.). This makes a highly reliable joint that is easily maintained.
- **Easy to assemble** – Small seal area under pressure makes for high-pressure capability at relatively low torque levels. This allows the use of small wrenches for easy installation and maintenance.
- **Wide temperature and media compatibility** – Metal to metal seal allows a range of uses and many applications.
- **Tube materials** – Triple-Lok® fittings can be used with most tube materials, such as high and low-grade steel or stainless steel, copper and aluminium.
- **No minimum tube wall limitation** – Triple-Lok® fittings are suitable for very thin to medium wall tubing. The optimum wall thickness tubing can be used, reducing overall system cost.
- **Ease of installation and maintenance** – Short tube entry means that installation is simplified and minimum tube prying is necessary when maintenance is required on the system. It is easy and quick.
- **Adaptability to metric & inch tubing** – Triple-Lok® fitting sleeves make the system suitable for inch and metric tubing by merely changing the sleeve.
- **Adaptability to hose assembly** – Triple-Lok® fittings allow for direct connection to 37° flare hose assemblies, the most popular industrial hose connection worldwide.
- **Forged shapes** – Triple-Lok® fittings have no braze joints to leak. Forgings provide higher dependability and longer life compared to multiple component brazed constructions.
- **Hard forgings** – High hardness of Triple-Lok® fittings forged shapes minimises the deformation of the 37° nose during assembly, maintaining full flow area and good reuseability.
- **Cold formed sleeves and nuts** – Sleeves and nuts in popular sizes are cold formed for high strength and toughness through optimum grain flow. This imparts high dependability and long service life.
- **International standard design** – Triple-Lok® fittings offer worldwide availability and interchangeability, they conform to SAE and ISO standards. 37° fittings are the most widely used fitting type in the world.
- **Availability** – Triple-Lok® fittings offer the broadest range of sizes and configurations of any fitting. This provides users with the optimum choice of tube fitting options. Standard materials offered are steel, stainless steel and brass.

### Adapters – introduction

In addition to the tube fittings described earlier, there are needs for other adapters to complete hydraulic circuits which perform different functions:

- **Thread size adapters** – to reduce or expand the existing thread
- **Thread conversion adapters** – to change from one port thread to another to allow tube fitting or hose connections
- **Hose end adapters** – hose to port, hose to hose etc.
- Blanking plugs.

The range of Tube Fittings products, when used without the tube nut and ring/sleeve, can also be used as hose adapters to allow the corresponding hose assembly to connect to a port.

Adapters are frequently used in maintenance situations, where equipment is used outside the region in which it was manufactured. For example to convert BSPP threads from a European manufacturer to an American thread alternative – UNF or NPT. Adapters are therefore often the most economical way to solve short-term problems.

There are many types of threads used in the Fluid Power industry throughout the world. This section contains adapters with a wide range of those thread types including: NPT, NPTF, NPSM, BSPT, BSPP, SAE, UN/UNF, and Metric. All threads in this section are made to industry specifications with conformance shown in Table F1.

Thread	Standard
NPT	ANSI B1.21.1, FED-STD-H28/7
NPTF	SAE J476, ANSI B1.20.3, FED-STD-H28/8
NPSM	ANSI B1.20.1, FED-STD-28/7
BSPT	BS 21, ISO 7/1
BSPP	BS 2779, ISO 228/1
Metric	ISO 261, ANSI B1.13M, FED-STD-H28/21
UN/UNF*	ANSI B1.1, FED-STD-H28/2

Table F1 – Thread conformance standards

Adapters from Parker Hannifin are manufactured from drawn barstock for straight parts, or from forgings in the case of elbows, tees and crosses, to give higher durability and long term performance. Pressure ratings are based on the same requirements used for the tube fittings product ranges. Parts are corrosion protected also to the same high standard found in other Tube Fitting Division products.

### Adapters – function

#### NPT/NPTF adapters

Commonly known as pipe thread adapters in USA, NPT and NPTF (Dryseal) adapters have tapered threads. These threads feature a 60° flank angle and 1°47" taper, as shown in Fig. F1. Because of the taper, they are commonly used in the USA as adjustable fittings in the elbow and tee forms. It has been found that although NPT/NPTF have a high static pressure capability, they are unreliable in dynamic applications, especially in the larger thread sizes 1" and above. Parker therefore recommends the use of alternative thread forms and sealing, based on elastomeric seals for new applications and designs.

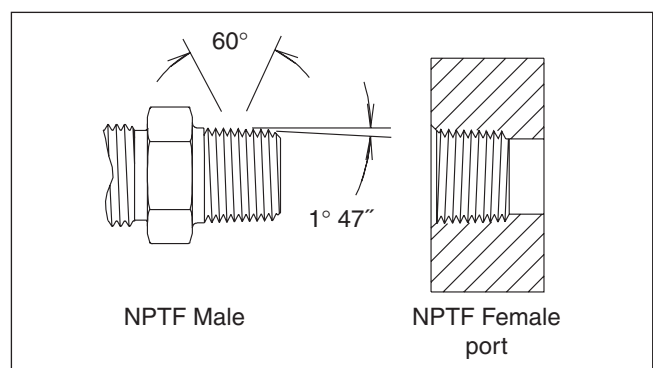

Fig. 1 – NPTF thread

NPT threads when assembled without a sealant, leave a spiral leak path at the crest-root junction as shown in Fig. F2. To seal pressurised fluid, NPT threads need a suitable sealer.

NPTF threads (Dryseal) on the other hand, when assembled, do not leave such spiral leak path. This is because they have controlled truncation at the crest and root, ensuring metal to metal crest-root contact as the male-female thread flanks make contact as seen in Fig. F3. Upon further tightening, the thread crests are flattened out until the flanks also make metal to metal contact as seen in Fig. F4. Theoretically, at least, there is no passage left for the fluid to leak, provided all surfaces are flawless and dimensions exact. In the real world, however, this is not the case and a sealant/lubricant is necessary to achieve a leak free joint even with NPTF threads. Because of the higher surface pressure contact with the NPTF design, Parker manufactures all Stainless steel adapters with the NPT thread form to reduce the possibility of thread galling (Cold welding effects).



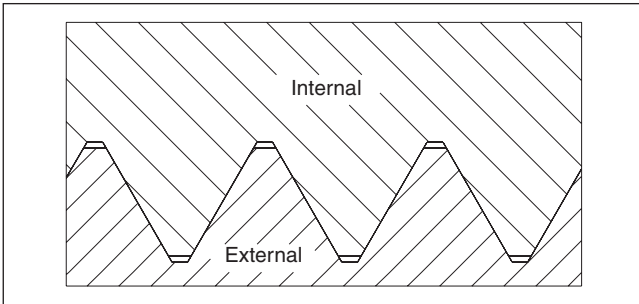

Fig. 2 – NPT – Wrench tight – No Crest-Root contact, Flank contact only.

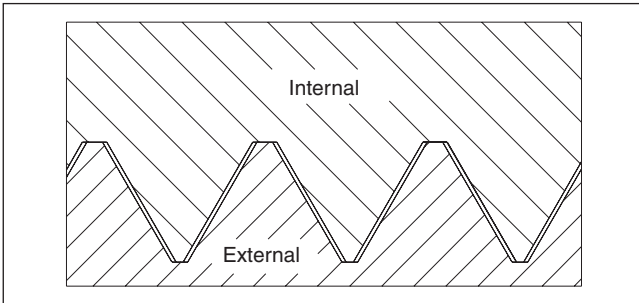

Fig. 3 – NPTF – Hand tight crest-root contact

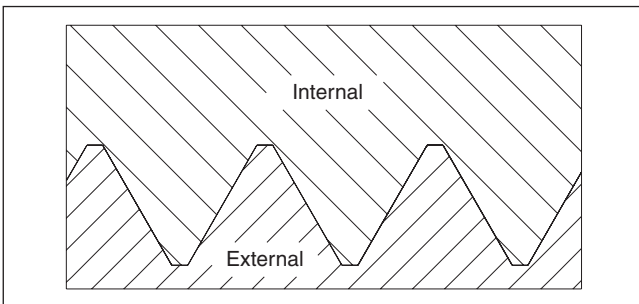

Fig. 4 – NPTF – Wrench tight crest-root and flank contact

### Type of sealant/lubricant

Sealant/Lubricant assist in sealing and provide lubrication during assembly, reducing the potential for galling. Pipe thread sealants are available in various forms such as dry pre-applied, tape, paste and anaerobic liquid. PTFE tape, if not applied properly, can contribute to system contamination during assembly and disassembly. Paste sealants can also contribute to system contamination, if not applied properly. They are also messy to work with, and some types require a cure period after component installation, prior to system start up.

### BSPT adapters

BSPT threads came from the British gas industry, where the outside diameter of a gas pipe was threaded at the end to allow a connection to be made. The thread form has a 55 degree flank angle, and the thread pitch is dif-

ferent generally to NPT threads. Therefore the two forms are not compatible. Today the BSPT thread is used in the pneumatics industry, but use on the hydraulics side is limited. In most cases, the BSPT male stud is screwed into a BSPP – parallel – port. Thread engagement in this situation is limited, giving lower holding power compared to NPT equivalents.

To seal BSPT threads, a sealant is always needed, since the sealing function is on the threads. BSPT fittings offer a limited adjustability when using elbow or tee types, and it is easy to overtighten and damage the port thread, stud thread or both. Re-useability is also therefore very limited. For all these reasons, BSPT threads should be limited to lower pressure applications with limited dynamic changes in pressure. Parker Hannifin does not use BSPT threads in it's "Dry Technology" programmes for this reason.

### UNF thread adapters

#### Function of UNF adapters

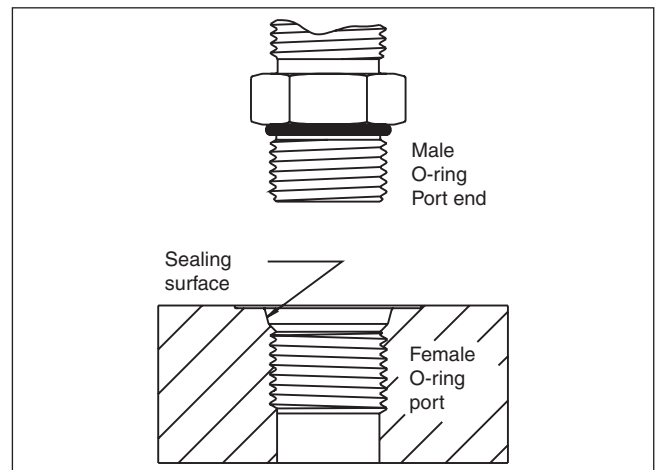

Fig. 5 – UNF port

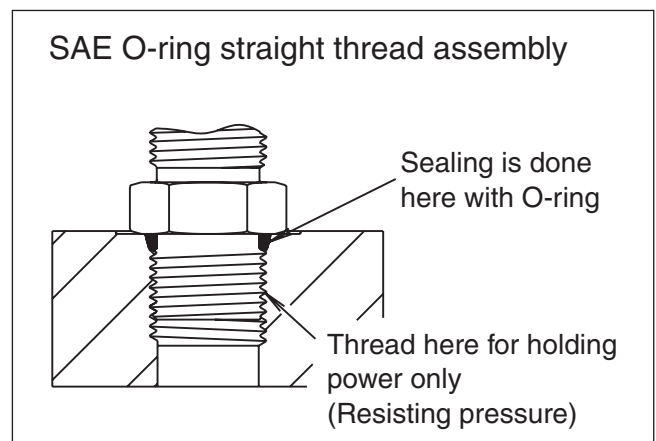

Fig. 6 – UNF port assembly

## Function of fittings

Parker fittings incorporating UN/UNF thread, O-ring port studs shown in this section are for connection with the UN/UNF thread ports. They are also known as O-Ring Boss (O.R.B.) connections. When properly assembled, they give performance equal to the best leak-free port connection available.

For this style of connection, the sealing and holding functions are separated. The threads have only the holding function. Thread tolerances are wider between the male stud and female port, and so the sensitivity to damage of the threads is much lower than the NPT for example. Sealing is achieved via a high durometer O-ring seal seated in a specially machined chamfer at the top of the port thread. When energised under pressure, the O-ring seals the only leak path. Good initial compression of the seal, means that the joint is leak tight at low and high pressures.

### Features, advantages and benefits

#### SAE straight thread

- **Elastomeric seal** – SAE straight thread O-ring connections offer a high sealing reliability, especially in dynamic and shock loading applications. The O-ring seal offers a high tolerance to minor surface imperfections and damage.
- **Ease of assembly** – This design is extremely easy to assemble, even for less experienced workers.
- **Infinite positioning of shaped fittings** – Due to the design of shaped fittings, incorporating adjustable SAE straight thread connections, they allow for infinite positioning of the port end. Aligning for tube and hose connections is much easier as compared to tapered threads.
- **Reusability** – Since the sealing and mechanical holding functions are separated, the SAE straight thread male studs can be re-used many times simply by changing the O-ring.

### ISO 6149 adapters

The ISO 6149 connection design is similar to the UN/UNF, but with metric threads. The pressure performance of the connections is therefore similar, and also the user-friendly assembly characteristics. This design is recommended by the ISO standards committee for all new applications and designs. The ISO 6149 thread has gained widespread use with OEM's in the agricultural and construction equipment segments. Parker Hannifin offers one of the widest range of tube fittings and adapters to the ISO6149 standard.

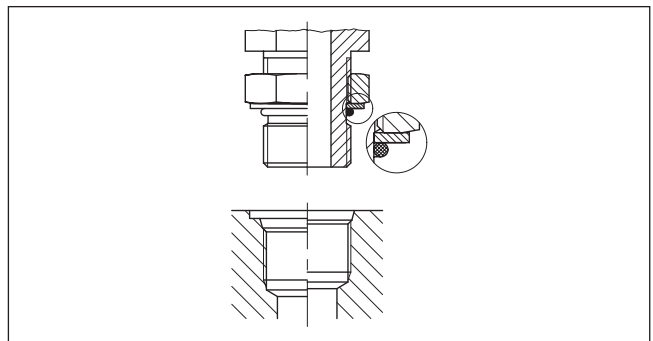

Fig. 7 – Adjustable UNF Port connection

### Japanese Industrial Standard (JIS) adapters

JIS adapters are typically used as hose adapters on equipment designed or built in Japan or Korea. Sealing is achieved with a line contact between the surfaces of mating 60 degree cones on the fitting and the hose end. These adapters are made according to the JIS B8363 standard. Although they have the same cone angle and threads as the BSPP 60 degree cone adapters below, they are not interchangeable. (Longer thread lengths on the JIS female swivel fittings lead to threads bottoming out before the seal is made on the corresponding BSPP fitting).

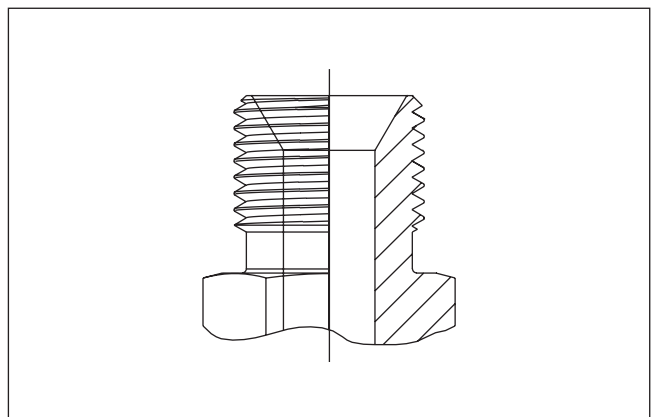

Fig. 8 – JIS adapter

### BSPP thread adapters

British Standard Pipe (Parallel) threads are still the most widely type used today in the Fluid Power Industry in Europe. This section is split into two parts, covering the thread adapters and later the BSP hose adapters.

### Function of 60 Deg cone

This form of BSPP adapter which has been modified to work as a hose adapter is still popular in the UK, Scandinavia and throughout the rest of Europe. These connections are standardised in BS5200. The bore of the BSPP thread is coned inwards with a 60 degree included angle

to match with a male cone of the same angle on a Swivel Female hose end see figure 9 below. When the nut is tightened, the two cone halves are clamped together to form a metallic seal. This type of connection is flexible in use, since the same thread end could also be used to screw into a BSPP threaded port. In this case a seal would be needed, normally a bonded washer consisting of a metallic outer ring and an elastomeric inner seal part.

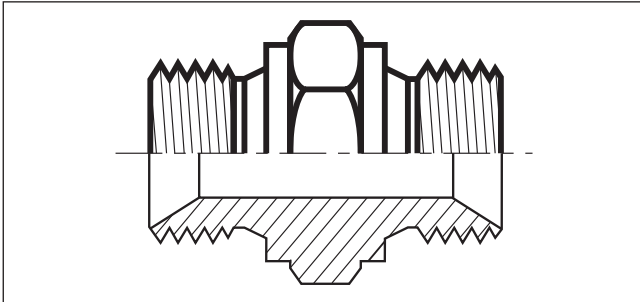

Fig. 9 – BSPP 60° cone adapter

Despite this flexibility, these adapters cannot be used as tube fittings in the same way as Triple-Lok®, O-Lok® or EO fittings, and therefore cannot be classed as a “universal system”.

Many manufacturers produce the elbow and tee adapters by brazing together straight parts. This can result in the fitting being effectively annealed during the brazing process, and therefore the material is left in its softest state. Parker tees and elbows are manufactured from high integrity forgings and offer superior long term performance.

### Function of BSPP thread adapters

BSPP thread adapters are designed to work with ports that have been machined with a flat ‘spot face’ concentrically around the thread. This spot face provides a consistent flat sealing area, whether the port is in a machined valve block, or on the face of a pump housing casting. Originally, the sealing was in the form of a copper (or other ductile metal) washer, but today most adapters use some form of elastomeric seal.

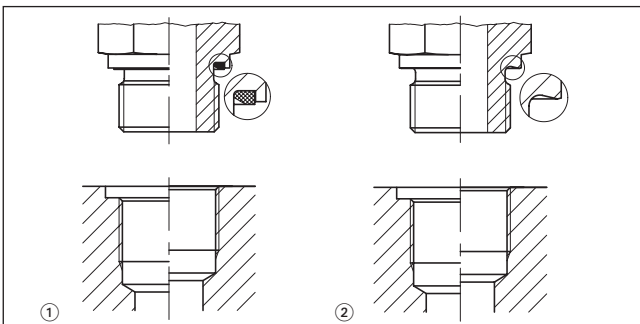

Fig. 10 – ① O-ring with retainer ring; ② Form A

The highest performance is achieved by the ED seal version, followed by the O-ring and retainer ring, bonded washer and lastly the German “Form-B” metallic sealed design. In terms of adjustable fittings, they are only normally available in the O-ring and retainer version. The ED seal design does not lend itself to adjustability.

### Metric thread adapters

Metric thread adapters have developed in parallel with the BSPP threaded adapters with a similar design based around the metric thread sizes.

### Pipe (NPSM) swivel adapters

#### Function of NPSM swivels

NPSM swivel adapters are designed for use with male NPT/NPTF hose fittings that have a 30° machined seat. NPSM adapters do not seal on the threads like most NPT thread adapters, they seal on the nose of the NPSM swivel and the seat on the male NPT/NPTF pipe thread. This creates a metal to metal seal as shown in Fig. 11. The most important preparation prior to assembly is to make certain that the mating male NPT/NPTF pipe thread has a 30° seat as shown in Fig. 12.

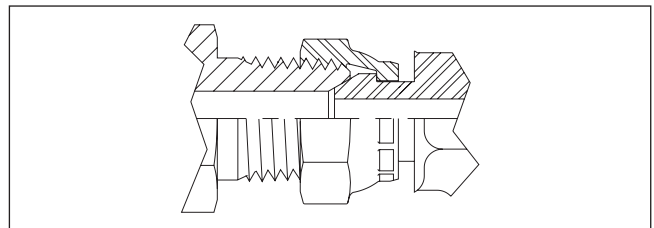

Fig. 11 – Illustration showing how NPSM swivel adapters seal on mating chamfer in male NPT thread

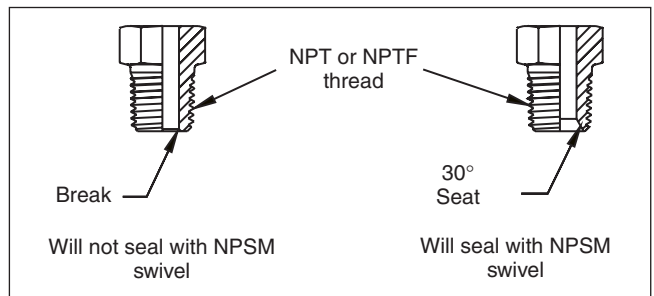

Fig. 12 – Illustration showing the required 30° seat on NPT/NPTF threads for NPSM swivel to seal

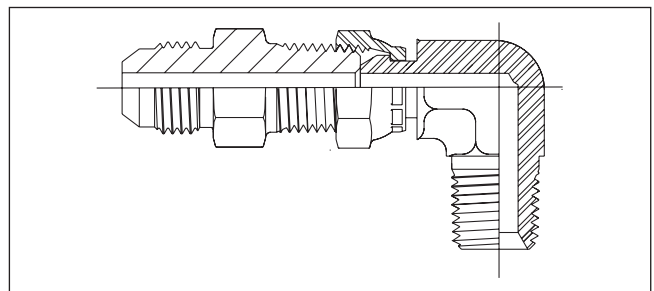

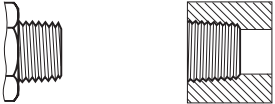
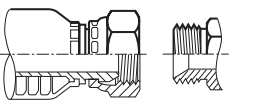
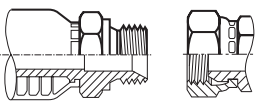
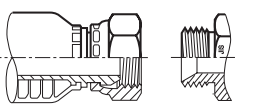
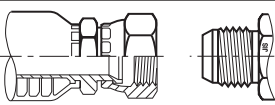
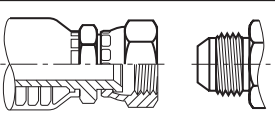
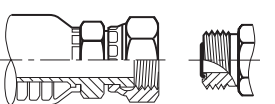

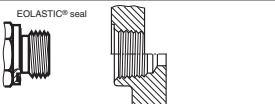
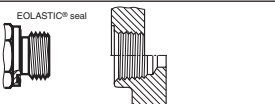
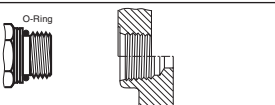
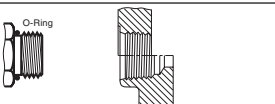
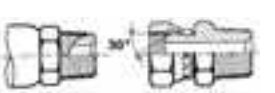

Fig. 13 – Chamfer of NPT/NPTF male thread does not provide appropriate contact for a reliable seal with cone of NPSM swivel

Thread configurations

<p>Taper thread adapters NPTF and</p>		<p>NPTF thread SAE J476-B2</p>
<p>BSPT</p>		<p>BSPT taper thread ISO 7</p>
<p>BSPP 60° cone adapters</p>		<p>BSPP male parallel thread 60° female cone BS5200</p>
		<p>BSPP female parallel thread 60° male cone BS5200</p>
<p>JIS adapters</p>		<p>BSPP male parallel thread JIS B8363 60° female cone</p>
		<p>BSPP female parallel thread JIS B8363 60° male cone</p>
<p>37° Flare (Triple-Lok®) and</p>		<p>SAE 37° Flare UNF thread SAE J514 ISO 8434-2</p>
<p>ORFS (O-Lok®) adapters</p>		<p>ORFS (O-ring Face Seal) UNF thread SAE J1453 ISO 8434-3</p>
<p>Male studs and female port threads</p>		<p>BSPP parallel thread O-ring and retaining ring according to ISO 1179</p>
		<p>BSPP parallel thread with ED seal according to ISO 1179-2</p>
		<p>Metric parallel thread with ED seal according to ISO 9974-2</p>
		<p>Metric straight thread ISO 6149-2+3</p>
		<p>UN/UNF threads SAE J475 thread ISO 11926-2/-3</p>
<p>NPSM female Swivel adapters</p>		<p>Hose adapters National pipe straight thread for mechanical joint 30° cone male / NPTF male thread. SAE J516</p>

# Hydraulic & Offshore SUPPLIES



Offshore House, Southwick Industrial Estate, Sunderland, SR5 3TX  
hos@hos.co.uk | [www.hos.co.uk](http://www.hos.co.uk)

