

**Hydraulic
& Offshore
SUPPLIES**



**Monoblock Directional
Control Valves
MB-2 Series**

Contact our team *and*
Order today on:
+44 (0)191 549 7335

Offshore House, Southwick Industrial Estate, Sunderland, SR5 3TX
hos@hos.co.uk | www.hos.co.uk

MB-2 SERIES

Monoblock Directional Control Valves

FOR MOBILE AND INDUSTRIAL
HYDRAULIC APPLICATIONS



Innovative Designs
Professional Quality
Customer Satisfaction !

MB-2 Chapters

Monoblock Directional Control Valves

Working condition	P.5
Ordering code	P.6
Dimensions	P.8
Performance data	P.9
Inlet relief options	P.10
Spool options	P.11
A side options	P.14
B side spool positioners	P.16
Inlet options	P.20





For Mobile And Industrial Hydraulic Applications.



MB-2

ONLY ONE SECTION AVAILABLE

Nominal flow rate	45 l/min	12 US gpm
Operating pressure (maximum)	250 bar	3600 psi
Back pressure (maximum) on outlet port T	25 bar	360 psi



MB-3

AVAILABLE SECTIONS FROM 1 TO 7

Nominal flow rate	45 l/min	12 US gpm
Operating pressure (maximum)	315 bar	4600 psi
Back pressure (maximum) on outlet port T	25 bar	360 psi



MB-4

AVAILABLE SECTIONS FROM 1 TO 6

Nominal flow rate	60 l/min	16 US gpm
Operating pressure (maximum)	315 bar	4600 psi
Back pressure (maximum) on outlet port T	25 bar	360 psi



MB-5

AVAILABLE SECTIONS FROM 1 TO 6

Nominal flow rate	80 l/min	21 US gpm
Operating pressure (maximum)	315 bar	4600 psi
Back pressure (maximum) on outlet port T	25 bar	360 psi

MONOBLOCK DIRECTIONAL CONTROL VALVES

MB-2 / MB-3 / MB-4 / MB-5 / MSB-5

SECTIONAL DIRECTIONAL CONTROL VALVES

SN-3 / SN-4 / SN-6



MSB-5

AVAILABLE SECTIONS FROM 1 TO 6

With Independent load check valve in each section, and optional port relief.

Nominal flow rate	80 l/min	21 US gpm
Operating pressure (maximum)	315 bar	4600 psi
Back pressure (maximum) on outlet port T	25 bar	360 psi



SN-3

AVAILABLE SECTIONS FROM 1 TO 12

Nominal flow rate	50 l/min	13 US gpm
Operating pressure (maximum)	315 bar	4600 psi
Back pressure (maximum) on outlet port T	25 bar	360 psi



SN-4

AVAILABLE SECTIONS FROM 1 TO 12

Nominal flow rate	80 l/min	21 US gpm
Operating pressure (maximum)	315 bar	4600 psi
Back pressure (maximum) on outlet port T	25 bar	360 psi



SN-6

AVAILABLE SECTIONS FROM 1 TO 12

Nominal flow rate	140 l/min	37 US gpm
Operating pressure (maximum)	315 bar	4600 psi
Back pressure (maximum) on outlet port T	25 bar	360 psi

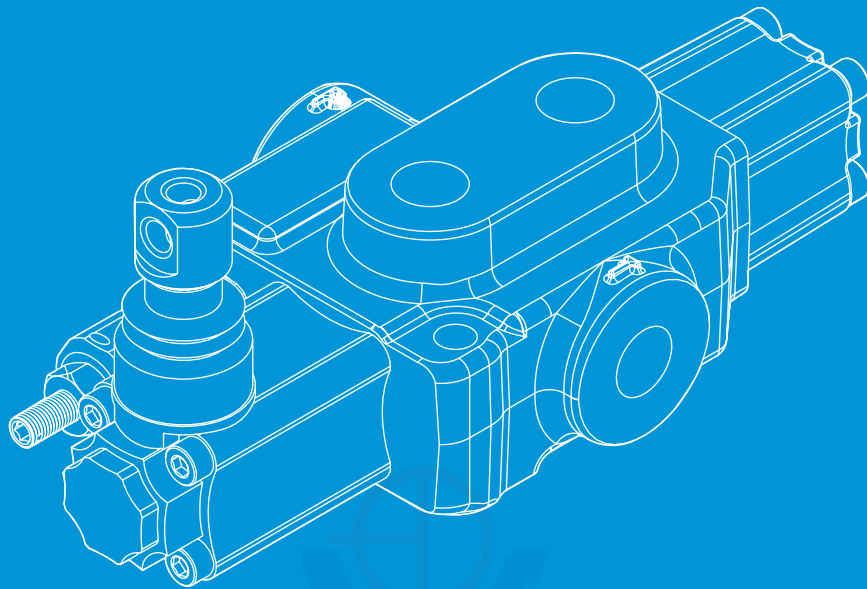

Innovative Designs
Professional Quality
Customer Satisfaction !

ONLY ONE SECTION AVAILABLE

MB-2

Monoblock Directional Control Valves



MB-2

Monoblock Directional Control Valves

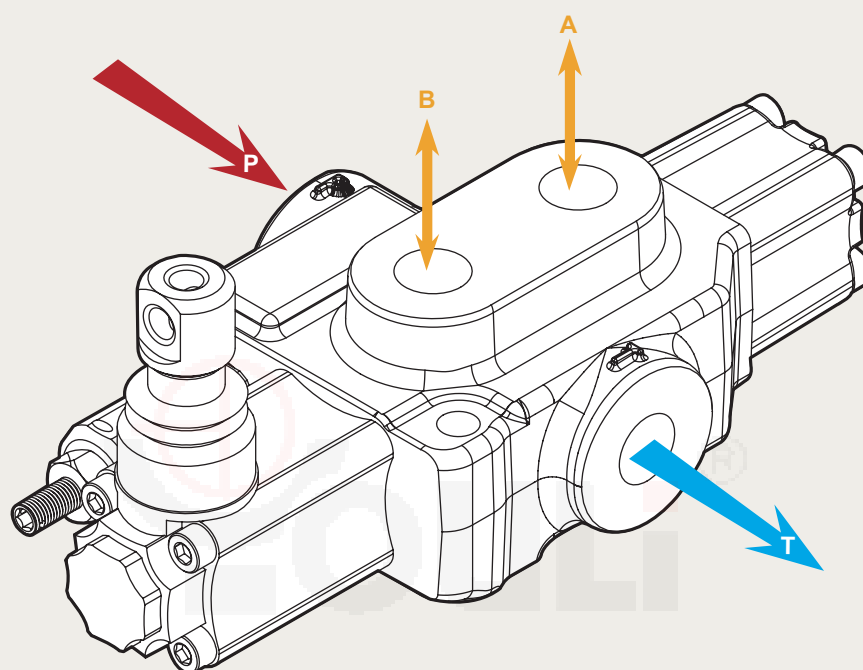

MB-2 Specifications

Nominal flow rate		45 l/min	12 US gpm
Operating pressure (maximum)		250 bar	3600 psi
Back pressure (maximum)	on outlet port T	25 bar	360 psi
Fluid temperature range	with NBR(BUNA-N) seals	from - 20° to 80°C	from - 4° to 176° F
	with FPM(VITON) seal	from - 20° to 100°C	from - 4° to 212° F
Viscosity	operating range	from 15 to 75 mm ² /s	from 15 to 75 cst
	min	12 mm ² /s	12 cst
	max.	400 mm ² /s	400 cst
Ambient temperature range		from - 40° to 60°C	from - 40° to 140° F

• All specifications, dimensions and design characteristics shown in this catalogue are subject to change without notice.

MB-2

Monoblock Directional Control Valves

MB-2 / **1S** - **3** / **18L** / G-3 / M1
 1 2 3 4 5

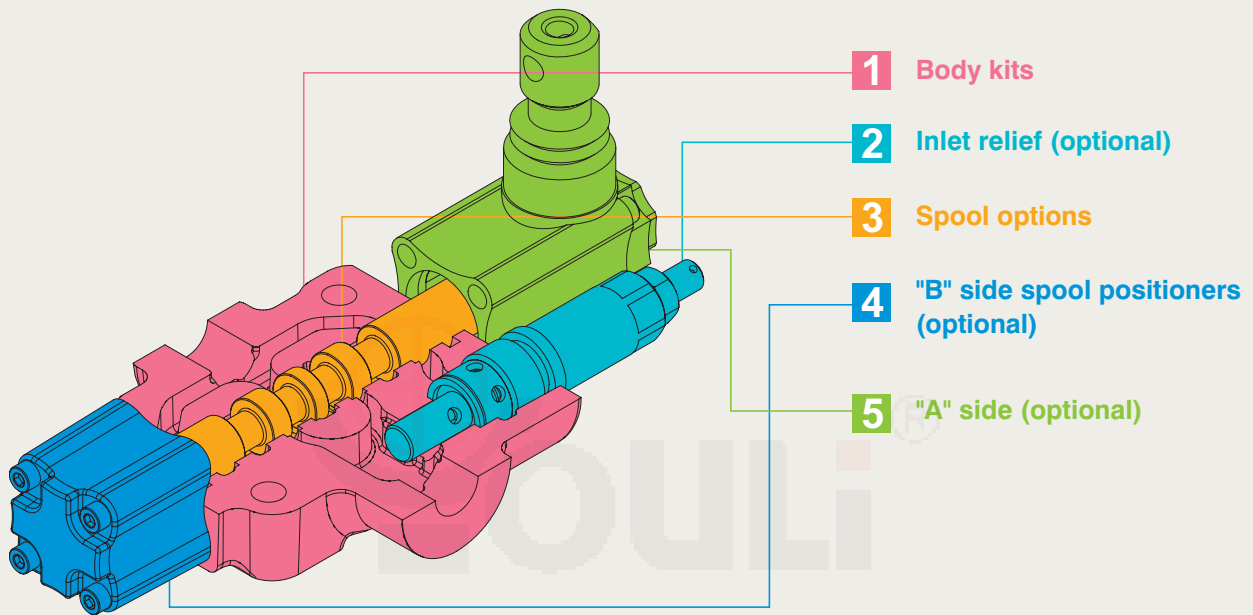

1:	Body kits	WITHOUT SERVICE PORT VALVES PREARRANGEMENT (INCLUDE BODY, SEALS, RINGS)
-----------	------------------	---

TYPE	DESCRIPTION
1 - S	1 section

2: Inlet Relief (optional)

TYPE	CODE	DESCRIPTION	PAGE
DG-2	YLMB32002	Range 40 to 80 bar / 580 to 1150 psi, standard setting 80 bar / 1150 psi	P. 10
DG-3	YLMB32003	Range 63 to 200 bar / 900 to 2900 psi, standard setting 120 bar / 1750 psi	P. 10
DG-4	YLMB32004	Range 160 to 315 bar / 2300 to 4600 psi, standard setting 220 bar / 3200 psi	P. 10
SV	YLMB32100	Relief valve blanking plug	P. 10

MB-2

Monoblock Directional Control Valves

3: Spool Options			
TYPE	CODE	DESCRIPTION	PAGE
1	YLMB23001	Double acting, 3 positions, with A, B closed in neutral position	P. 11
2	YLMB23002	Double acting, 3 positions, with A, B open to Tank in neutral position	P. 11
3	YLMB23003	Single acting on A closed in neutral position, 3 positions, B plugged	P. 12
4	YLMB23003	Single acting on B closed in neutral position, 3 positions, A plugged	P. 12
9	YLMB23009	Double acting, 3 positions, with P, T, A, B closed in neutral position (Closed center)	P. 13
10	YLMB23010	Double acting, 3 positions, with A, B open to Tank and P, T closed in neutral position (Closed center)	P. 13

4: B Side Spool Positioners			
TYPE	CODE	DESCRIPTION	PAGE
6-1	YLMB24061	Detent in pos. 1-0-2, without spring centered	P. 16
6-2	YLMB24062	2 positions, detent in pos. 0-2, without spring centered	P. 16
6-3	YLMB24063	2 positions, detent in pos. 1-0, without spring centered	P. 16
8D2	YLMB24200	With spring return to neutral position and pin with M8 male thread for dual control	P. 16
8EP3	YLMB24300	ON/OFF Electro-Pneumatic actuator	P. 17
8P	YLMB24080	ON/OFF Pneumatic actuator	P. 17
8MG1 (NO)	YLMB24801	Microswitch kit operated in pos. 1 (Normally Open)	P. 18
8MG2 (NO)	YLMB24802	Microswitch kit operated in pos. 2 (Normally Open)	P. 18
8MG3 (NO)	YLMB24803	Microswitch kit operated in pos. 1&2 (Normally Open)	P. 18
MG (NO)	YLMB24804	Microswitch with NO terminal	P. 18
8MG1 (NC)	YLMB248011	Microswitch kit operated in pos. 1 (Normally Closed)	P. 18
8MG2(NC)	YLMB248021	Microswitch kit operated in pos. 2 (Normally Closed)	P. 18
8MG3 (NC)	YLMB248031	Microswitch kit operated in pos. 1&2 (Normally Closed)	P. 18
MG (NC)	YLMB248041	Microswitch with NC terminal	P. 18
8	YLMB24008	With spring return to neutral position	P. 19
8-1	YLMB24081	2 positions, with spring centered from pos. 1	P. 19
8-2	YLMB24082	2 positions, with spring centered from pos. 2	P. 19
9-1	YLMB24091	Detent in pos. 1, 2 with spring centered	P. 19
9-2	YLMB24092	Detent in pos. 2 with spring centered	P. 19
9-3	YLMB24093	Detent in pos. 1 with spring centered	P. 19

5: A Side (optional)			
TYPE	CODE	DESCRIPTION	PAGE
L	YLMB45000	Standard lever box	P. 14
SLP	YLMB45001	Without lever box,with dust-proof plate	P. 14
TQ	YLMB45003	Flexible cable connection	P. 15

MB-2 Dimensions

Monoblock Directional Control Valves

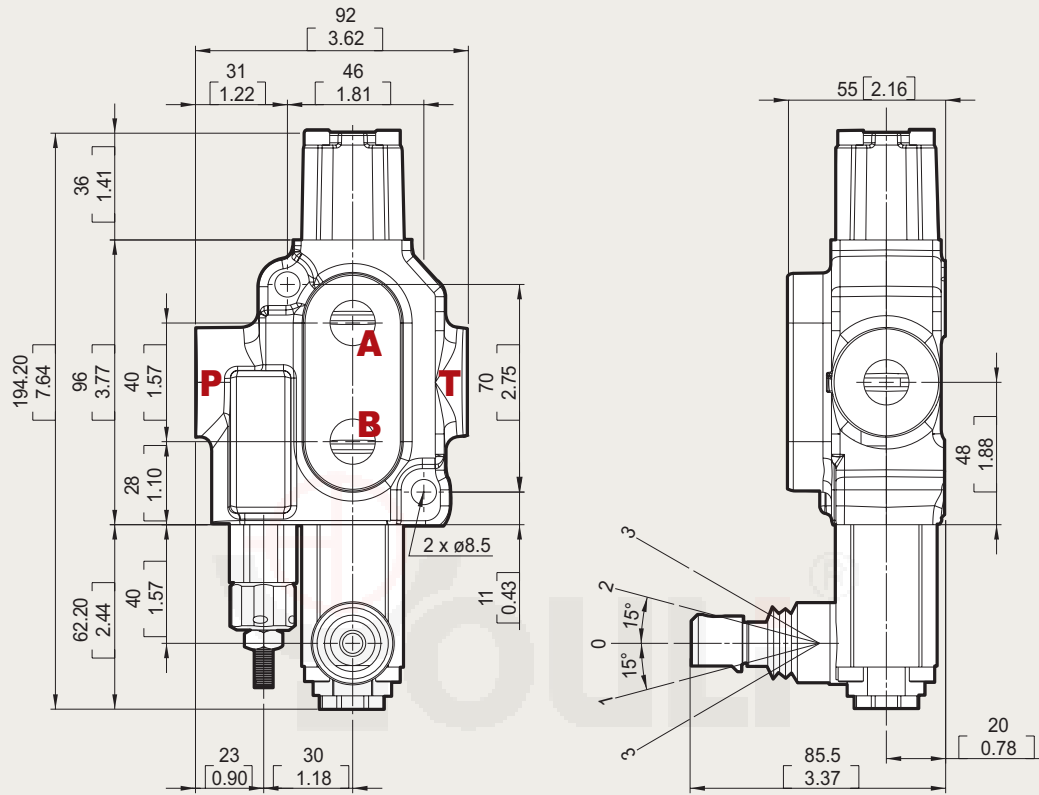

Standard threads

Ports	Inlet P	A and B	Outlet T
BSP	G3/8	G3/8	G3/8
UN-UNF	3/4-16 UNF-2B (SAE 8)	3/4-16 UNF-2B (SAE 8)	3/4-16 UNF-2B (SAE 8)
METRIC	M18x1.5	M18x1.5	M18x1.5

• G-1/2 : G4 G-3/8 : G3 G-3/4 : G6
 • SAE 8: E8 SAE 10: E10 SAE 12: E12 SAE 16: E16

MB-2 Performance curve chart

Monoblock Directional Control Valves

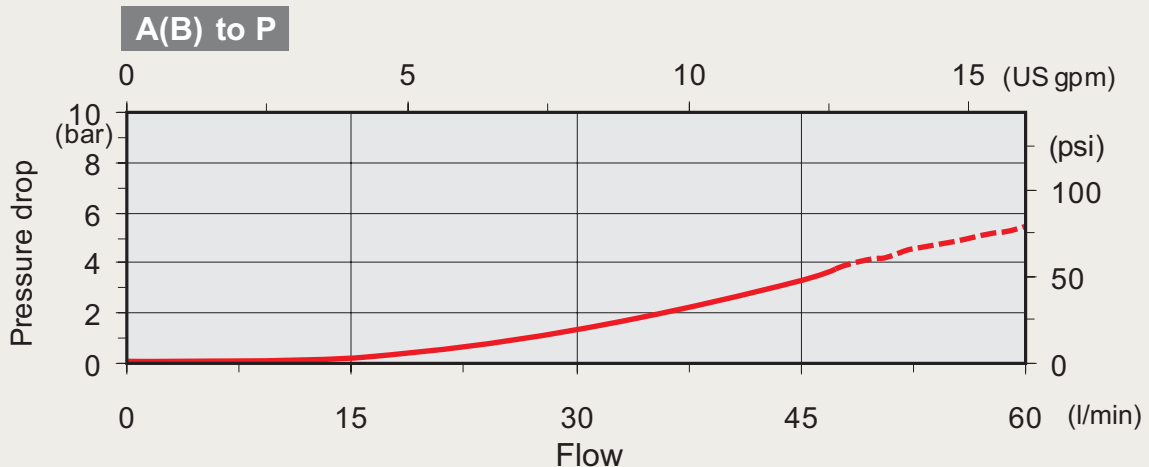
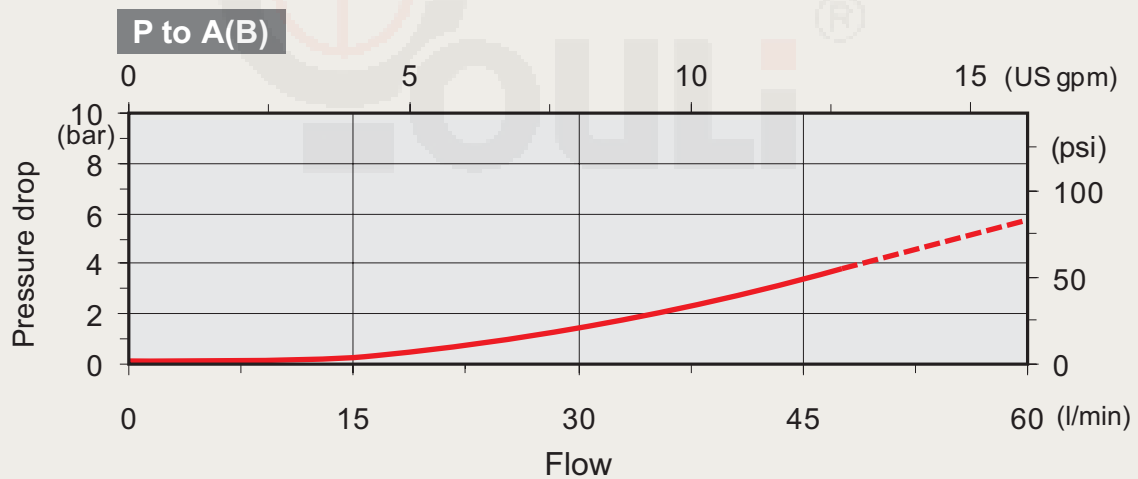
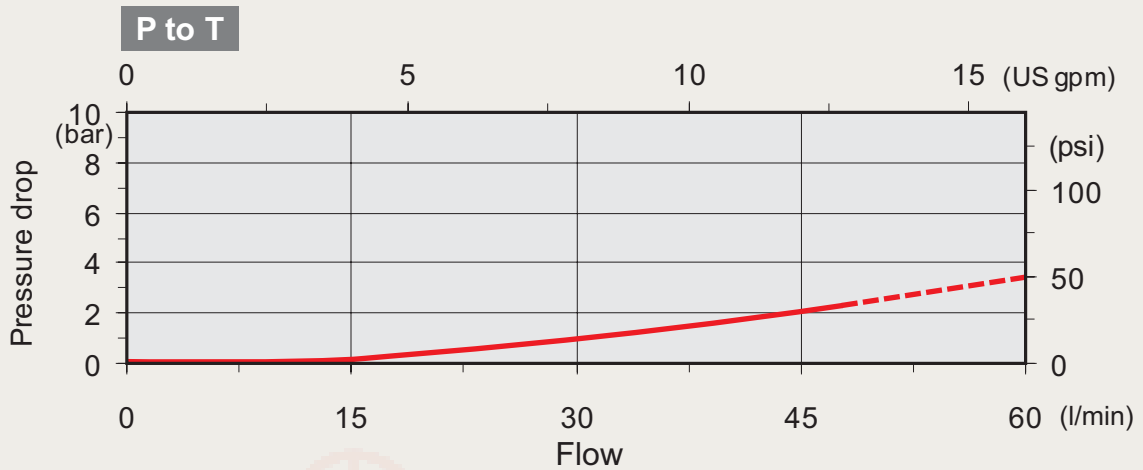

MB-2 Inlet Relief (Optional) Monoblock Directional Control Valves

Type DG

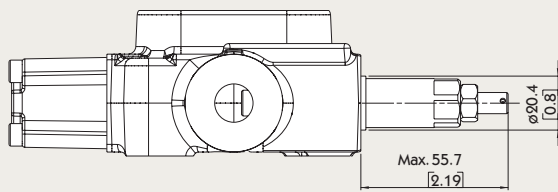

Direct pressure relief valve:

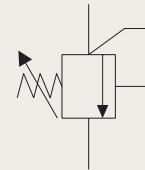

Type SV

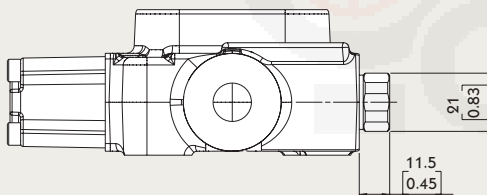

Relief valve blanking plug:



MB-2 Spool Options

Monoblock Directional Control Valves

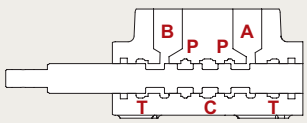
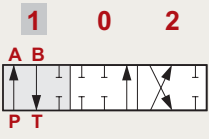
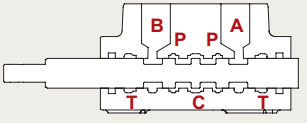
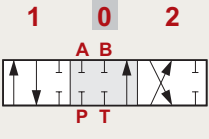
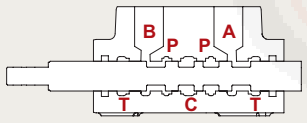
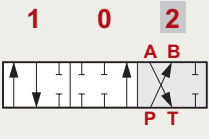
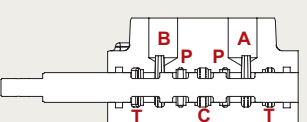
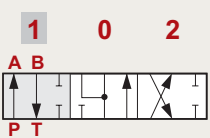
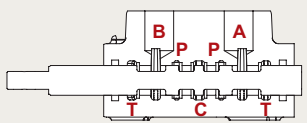
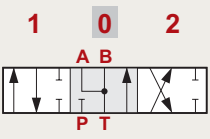
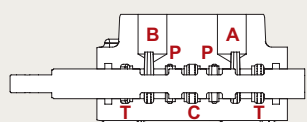
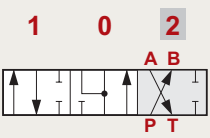
TYPE 1		
	<p>P → A</p> <p>B → T</p> <p>C closed</p>	<p>1 0 2</p> 
	<p>P & T & A & B closed</p> <p>C open</p>	<p>1 0 2</p> 
	<p>P → B</p> <p>A → T</p> <p>C closed</p>	<p>1 0 2</p> 
TYPE 2		
	<p>P → A</p> <p>B → T</p> <p>C closed</p>	<p>1 0 2</p> 
	<p>A & B → T</p> <p>C open</p>	<p>1 0 2</p> 
	<p>P → B</p> <p>A → T</p> <p>C closed</p>	<p>1 0 2</p> 

MB-2 Spool Options

Monoblock Directional Control Valves

TYPE 3

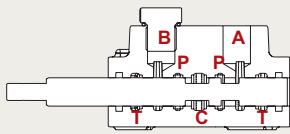

P → A
C closed

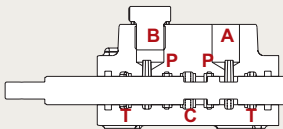
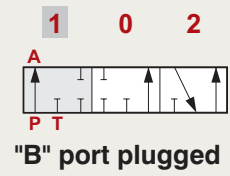

P & A & T closed
C open

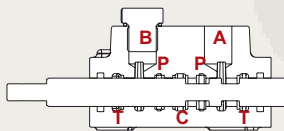
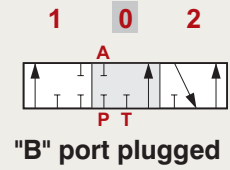

A → T
C open

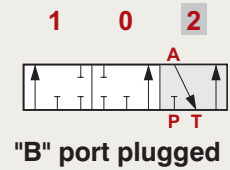

TYPE 4

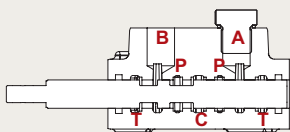

B → T
P closed
C open

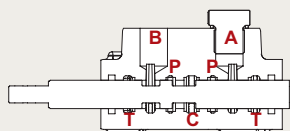
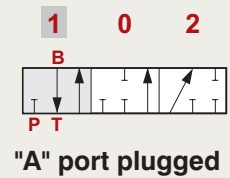

P & B & T closed
C open

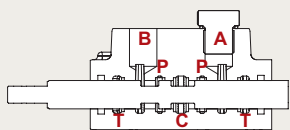
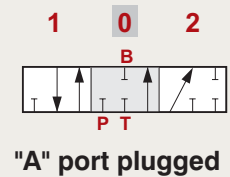

P → B
C closed

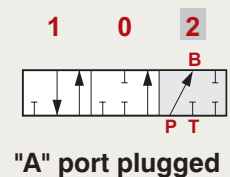

MB-2 Spool Options

Monoblock Directional Control Valves

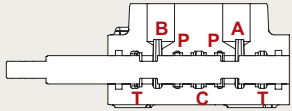
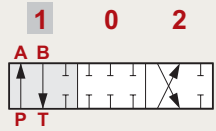
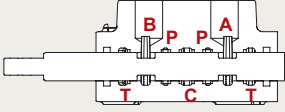
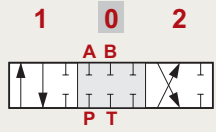
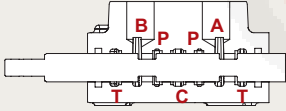
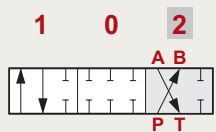
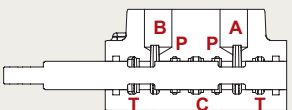
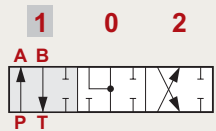
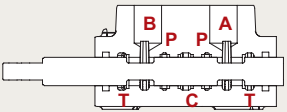
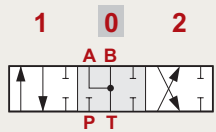
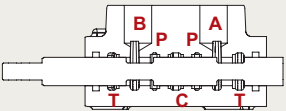
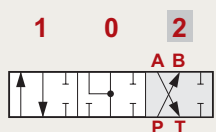
TYPE 9		
	<p>P → A B → T C closed</p>	
	<p>P & A & B & T closed C closed</p>	
	<p>P → B A → T C closed</p>	
TYPE 10		
	<p>P → A B → T C closed</p>	
	<p>A & B → T P & C closed</p>	
	<p>P → B A → T C closed</p>	

MB-2 A Side

Monoblock Directional Control Valves

Type L

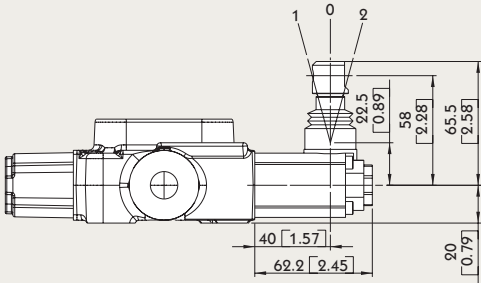

Type L:
STANDART LEVER KIT

Type R

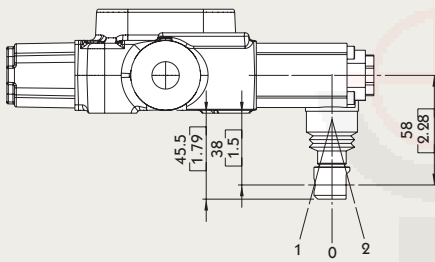

Type R:
STANDART LEVER KIT
(ROTATED 180 DEGREE)

Type SL

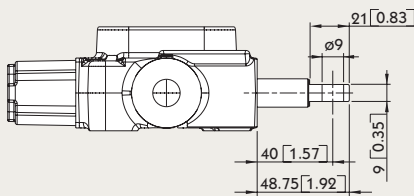

Type SL:
WITHOUT ANY COVER

Type SLP

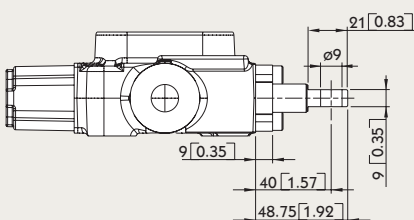

Type SLP:
WITH DUST-PROOF PLATE

MB-2 A Side

Monoblock Directional Control Valves

Note : CONNECTION KIT NOT INCLUDE CABLE

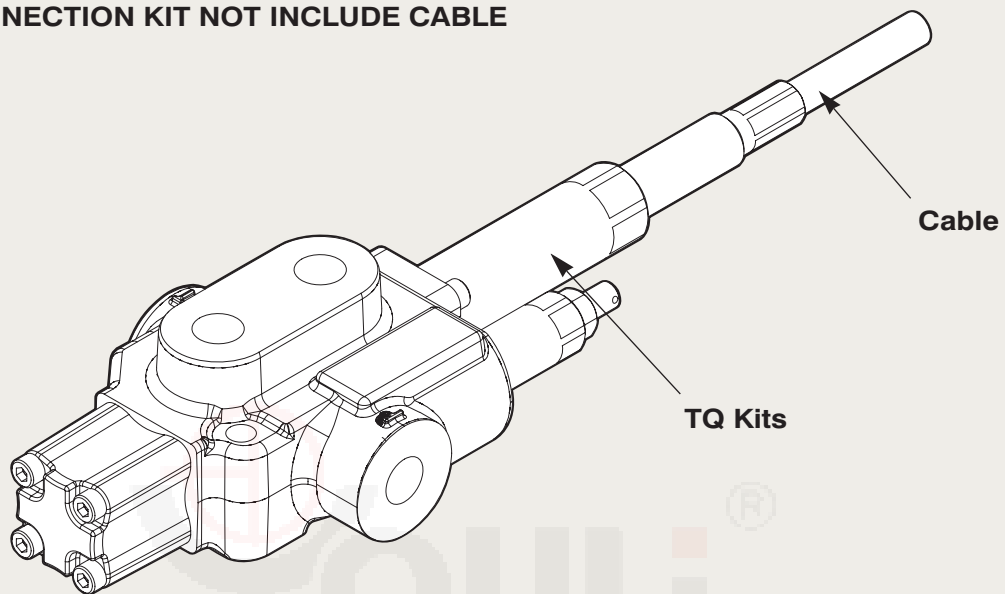

Type TQ

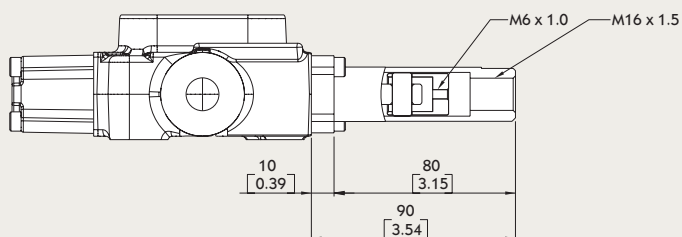

TQ Kit:



MB-2 B Side

Monoblock Directional Control Valves

Type 6

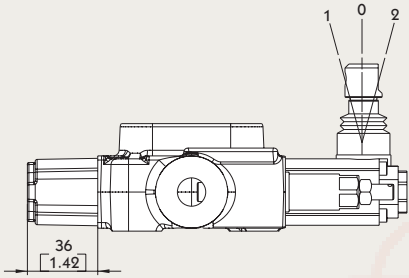

6-1 Kit:

DETENT IN POS. 1-0-2, WITHOUT SPRING CENTERED



6-2 Kit:

2 POSITIONS, DETENT IN POS. 0-2, WITHOUT SPRING CENTERED



6-3 Kit:

2 POSITIONS, DETENT IN POS. 1-0, WITHOUT SPRING CENTERED

Type 8D2

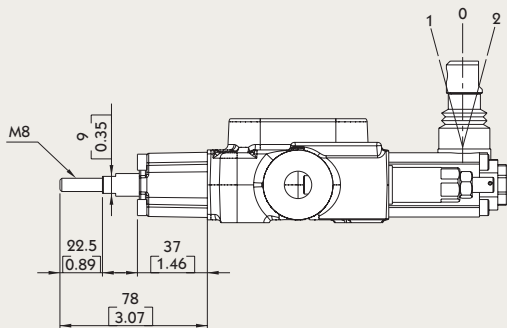

8D2 Kit:

WITH SPRING RETURN TO NEUTRAL POSITION AND PIN WITH M8 MALE THREAD FOR DUAL CONTROL

MB-2 B Side

Monoblock Directional Control Valves

Type 8P

V1 & V2: NPT 1/8 - 27

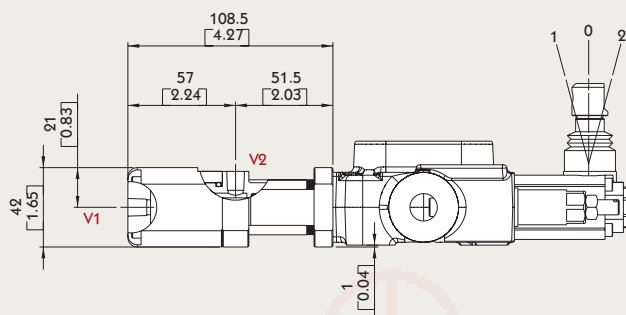

Operating feature :

PILOT PRESSURE (MIN.): 5.5 BAR / 80 PSI
 PILOT PRESSURE (MAX.): 10 BAR / 145 PSI



Type 8EP3

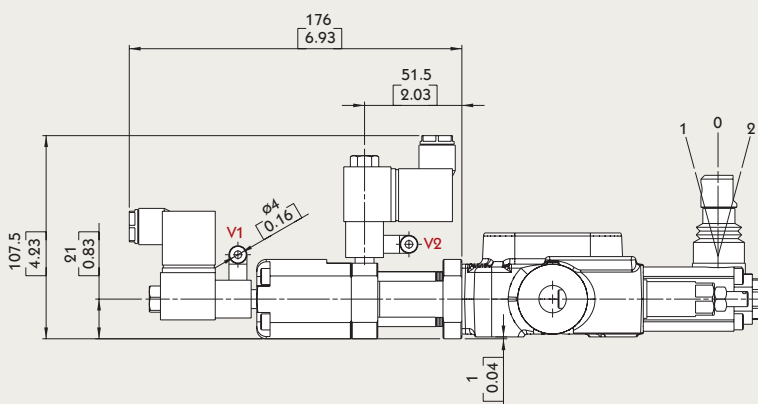

Solenoid operating features :

NOMINAL VOLTAGE: 24VDC
 NOMINAL VOLTAGE TOLERANCE: $\pm 10\%$
 POWER RATING: 5W

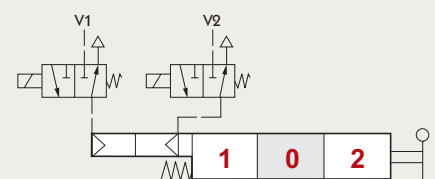

MB-2 B Side

Monoblock Directional Control Valves

Type 8MG

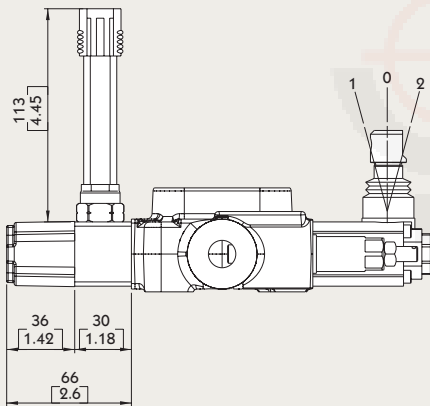

MICROSWITCH

Operating features :

MECHANICAL LIFE: • 5X10⁶ OPERATIONS

ELECTRICAL LIFE (RESISTIVE LOAD):

- 10⁶ OPERATIONS - 7A / 13.5 VDC
- 5x10⁴ OPERATIONS - 10A / 12 VDC
- 5x10⁴ OPERATIONS - 3A / 28 VDC

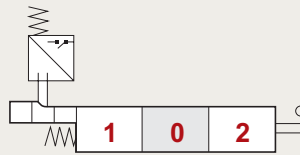

8MG1 Kit:

MICROSWITCH WITH MALE/FEMALE CONNECTOR, OPERATED IN POS. 1



8MG2 Kit:

MICROSWITCH WITH MALE/FEMALE CONNECTOR, OPERATED IN POS. 2

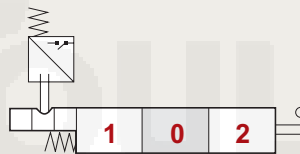

8MG3 Kit:

MICROSWITCH WITH MALE/FEMALE CONNECTOR, OPERATED IN POS. 1 AND POS. 2

With NO contact (female connector with male end)

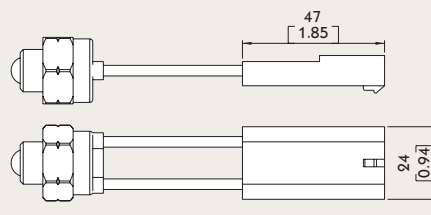



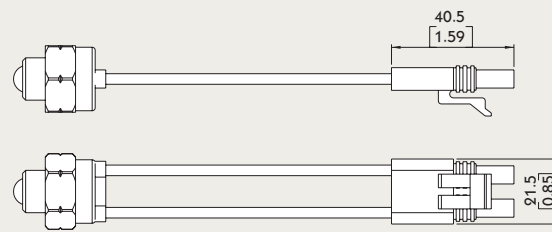



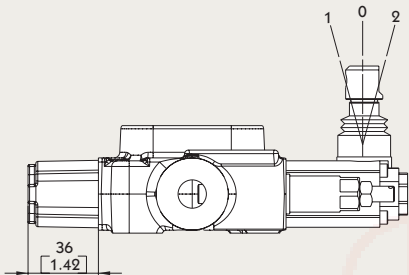

With NC contact (male connector with female end)

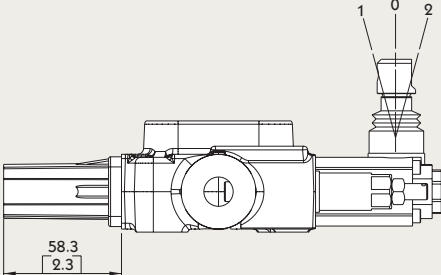

MB-2 B Side

Monoblock Directional Control Valves

Type 8		
		<p>8 Kit: SPRING RETURN TO NEUTRAL POSITION.</p>
		<p>8-1 Kit: SPRING RETURN TO NEUTRAL POSITION. (2 POSITIONS)</p>
		<p>8-2 Kit: SPRING RETURN TO NEUTRAL POSITION. (2 POSITIONS)</p>

Type 9		
		<p>9-1 Kit: DETENT IN POS. 1, 2 WITH SPRING CENTERED</p>
		<p>9-2 Kit: DETENT IN POS. 2 WITH SPRING CENTERED</p>
		<p>9-3 Kit: DETENT IN POS. 1 WITH SPRING CENTERED</p>

MB-2 Inlet

Monoblock Directional Control Valves

A symmetrical body allows the reverse assembly of spool and relative control kit and lever

(Left inlet)

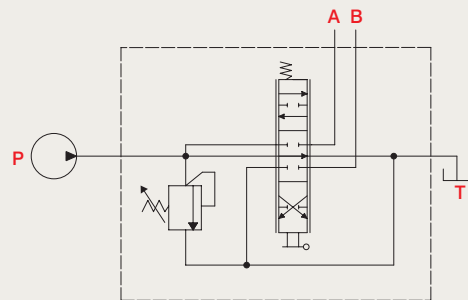
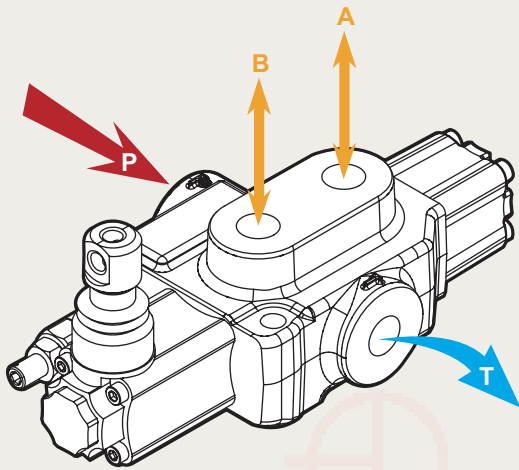

(Right inlet)

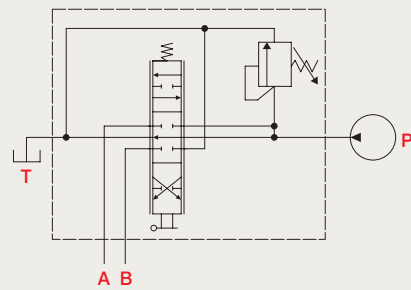
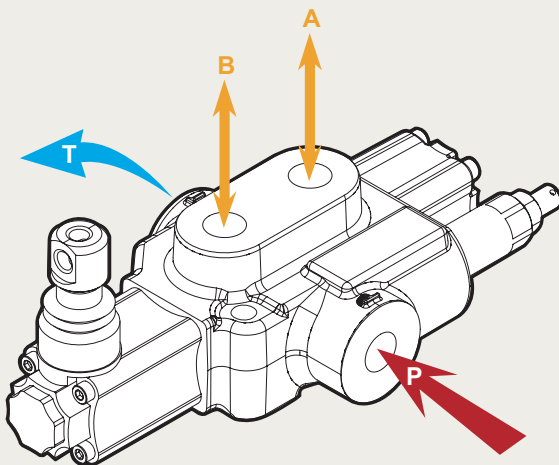

Memo

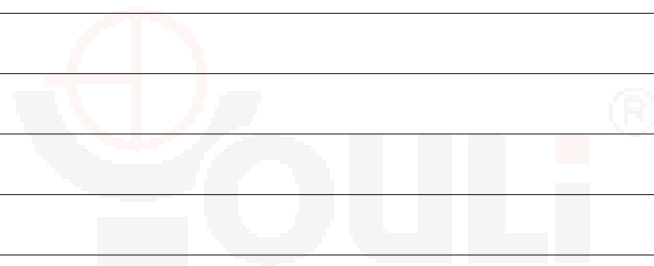

Memo

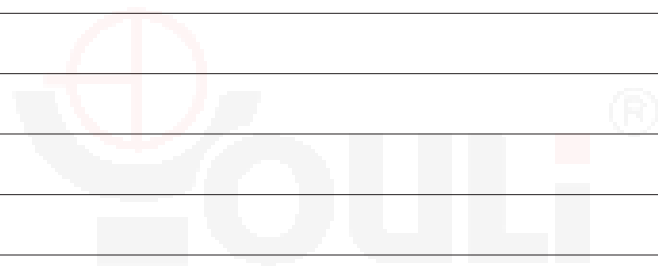

Memo

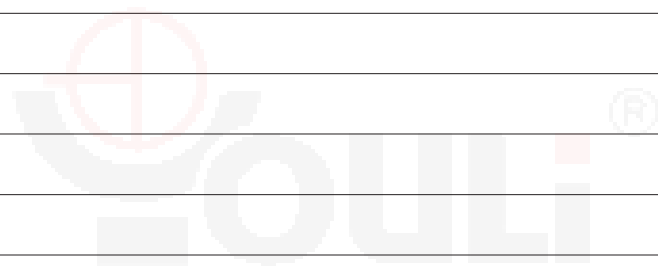

Hydraulic & Offshore SUPPLIES



Offshore House, Southwick Industrial Estate, Sunderland, SR5 3TX
hos@hos.co.uk | www.hos.co.uk

