

# Hydraulic & Offshore SUPPLIES

## Parker Assembly Tooling

Contact our team *and*  
**Order today on:**  
**+44 (0)191 549 7335**

Offshore House, Southwick Industrial Estate, Sunderland, SR5 3TX  
hos@hos.co.uk | [www.hos.co.uk](http://www.hos.co.uk)

## Assembly tooling

### Index

**Manual assembly tools**  
for EO/EO2



**VOMO**  
p. H5



**KONU**  
p. H6



**AKL**  
p. H7

**Manual assembly devices**



**HVM-B**  
p. H9



**EO-KARRYMAT**  
p. H11

**Assembly machines**  
for EO/EO2, Triple-Lok®



**EOMAT ECO**  
p. H13

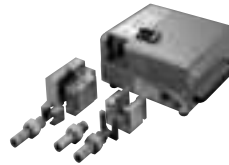

**EOMAT UNI**  
p. H15

**Forming machine**  
for EO2-FORM



**EO2-FORM F3**  
p. H21

**Manual flaring tools**  
for Triple-Lok®



**1004/210A**  
p. H25



**Impact flarer**  
p. H25



**KarryFlare**  
p. H28

**Parflange® Machines**  
for O-Lok®/Triple-Lok®



**1025**  
p. H31



**1050**  
p. H37

**Lubricants**

















**NIROMONT**  
p. H42

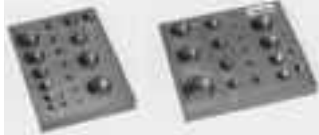

**LUBSS**  
p. H42

**Index**

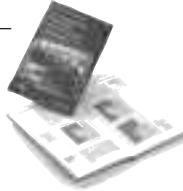
<p><b>Cutting, bending and deburring tools</b></p>	 <p><b>AV 6/42</b> p. H43</p>	 <p><b>BAV 6/12</b> p. H44</p>	 <p><b>IN-EX 226</b> p. H44</p>
<p><b>Tube bending tools</b></p>	 <p><b>BV 6/18</b> p. H45</p>	 <p><b>BV 20/25</b> p. H46</p>	
<p><b>Hand-tools</b></p>	 <p><b>Par-Lok wrench</b> p. H47</p>	 <p><b>WKZ - Tool box</b> p. H48</p>	
<p><b>O-Ring assembly tools for O-Lok®</b></p>	 <p><b>O-Lok® CORG</b> p. H49</p>	 <p><b>O-Ring Pick</b> p. H49</p>	
<p><b>Port manufacturing tools</b></p>	 <p><b>Counterbore</b> p. H50</p>	 <p><b>Thread taps</b> p. H50</p>	
<p><b>Thread identification</b></p>	 <p><b>Thread ID kit</b> p. H52</p>	 <p><b>Portboard</b> p. H52</p>	
<p><b>Training equipment/Books</b></p>	 <p><b>Training case</b> p. H53</p>	 <p><b>Pocket book</b> p. H54</p>	



### Parker tube fabricating equipment

Equipment described in this section is designed to make strong, accurate tubing systems easier and more dependable. Every time you make up a tubing circuit, you want to be sure you get strong dependable joints, accurate kink-free bends and a neat system that will stand up to years of hard service. You want to fabricate the system with the least effort and risk of errors.

Parker tube fabricating equipment is designed to help you get all these benefits. Parker has been leading the way in use of tubing and in fittings design for over 60 years. All this experience has shown Parker engineers a host of ways to make tube fabricating equipment more efficient and trouble free. You'll find them all in the equipment featured here – from improvements that help you make accurate concentric flares, to bender designs that make kink-free bending easier. They'll all help you get better tubing systems with less work and less risk of mistakes in fabrication.

### Machine selection

Parker offers a variety of assembly devices and machines for different products and different applications. Refer to overview in chapter E for machine recommendation.

### Disposal of old equipment

The TFDE electrically driven assembly machines are large stationary industrial tools within the meaning of the Electrical and Electronic Equipment Act (EC Directive 2002/96/EC/“WEEE Directive”). This equipment is not usually used in private households but in industry. Within the scope of the Electrical Act, industrial users are responsible for the professional disposal of old equipment.

### Service

Assembly machines and standard tooling for TFDE connectors are available from stock for immediate service. Both purchasing and leasing are possible depending on machine type and volume of business. For limited projects, assembly equipment can be provided on a rental basis via our certified distributor network. Special “demo”-equipment is available for sales presentations and fairs.

### Technical support

TFDE machine service procedures ensure that reliable machine function and fitting performance is achieved when using genuine Parker assembly equipment. All machines come with detailed operating manuals. Parker distributors and sales representatives are trained to give advice on operation and application. Experienced application engineers at TFDE are available when it comes to special application of TFDE assembly equipment. In case of machine malfunction, spare machines can be provided on short notice so that production can continue. In the meantime, damaged machinery is checked and repaired at the TFDE machine repair facility. Well trained and experienced engineers take personal care that the machines return properly repaired and tested.

TFDE also offers a machine maintenance and calibration service. Standard spare parts like oil filters can be ordered from stock.

### Repair procedure

Please contact your Parker Service Center for problem solving/repair. Your correspondent will organise the repair and arrange a spare machine if required. Please do not send in machines without notice to your sales correspondent. To assure optimum service, all machine shipments must include a documentation with information about: Machine type, serial number, purchase data, problem description, contact name, phone number and complete address for return.



Experienced engineers support proper operation of TFDE assembly machinery

### Tool lifetime

Assembly tools are subject of wear and must be regularly (max. 50 assemblies) cleaned and checked (Checking instructions see chapter E). Worn out tools can cause dangerous assembly failures and must be replaced in time. Average tool lifetime is approx. 5000 cycles when properly used. Maximum lifetime can be achieved by following factors:

- Regular cleaning and checking
- Clean and corrosion-protected storage
- Proper de-burring and cleaning of tube end
- Proper tool selection and operation
- Use of specified lubricant

# Manual assembly tools for EO/EO-2

## VOMO – Pre-assembly tools for EO/EO-2 tube connections

Simple but essential tool for the manual presetting of EO-fittings.

The use of a VOMO assures that the bite ring securely cuts into the tube without damage on the inner fitting cone.

Pre-assembly using VOMO or EOMAT must be done for all connections of:

- EO-2 with large tube dimensions (Tube O.D. 30 mm and above)
- EO-Progressive Stop Ring/Progressive Ring with stainless steel tube or standpipe fittings (E.g.: “BE”-type hose fitting).

For proper use, see EO assembly instructions. VOMO tools wear out and then may cause assembly failures. VOMO’s must be checked regularly with “KONU” cone gauges (max. after 50 assemblies) and replaced when damaged or worn out.

### Specifications:

Material: hardened tool steel

Sizes: 4 LL – 12 LL,  
6 L – 42 L,  
6 S – 38 S

Pre-assembly of: EO-2 and Progressive Stop Ring PSR/EO progressive Ring DPR

### Features, advantages and benefits of pre-assembly tools:

1. **Marking notch** – A special ridge engraves a circular mark onto the tube end to verify that it was properly bottomed at assembly. Failures caused by improper tube cutting or bottoming in VOMO can be recognised before final installation.
2. **Flexible** – A VOMO can be used anywhere to assure safe fitting assembly – even at assembly sites where EOMAT machines are not available.
3. **Safe** – Hazardous blowout of incorrect assembled standpipe hose fittings or stainless steel tube can be avoided by VOMO-assembly.



4. **Efficient** – There is no doubt that VOMO-presetting contributes to save time and effort in bite-type assembly. The small investment pays back immediately.
5. **Special** – VOMO tools are specifically designed and manufactured to match EO-fitting standards.
6. **Tool lifetime** – Assembly tools are subject of wear and must be regularly (max. 50 assemblies) cleaned and checked (Checking instructions see chapter E). Worn out tools can cause dangerous

assembly failures and must be replaced in time. Average tool lifetime is approx. 5000 cycles when properly used. Maximum lifetime can be achieved by following factors:

- Regular cleaning and checking
- Clean and corrosion-protected storage
- Proper de-burring and cleaning of tube end
- Proper tool selection and operation
- Use of specified lubricant

Series	Tube O.D. mm	Pre-assembly tools Order code	Cone gauges Order code
LL	4	VOMO04LLX	KONU04+06LLX
	6	VOMO06LLX	KONU06+08LLX
	8	VOMO08LLX	
	10	VOMO10LLX	KONU10+12LLX
	12	VOMO12LLX	
L	6	VOMO06LX	KONU06+08LX <sup>1)</sup>
	8	VOMO08LX	KONU10+12LX <sup>1)</sup>
	10	VOMO10LX	
	12	VOMO12LX	KONU15+18LX
	15	VOMO15LX	
	18	VOMO18LX	KONU22+28LX
	22	VOMO22LX	
	28	VOMO28LX	KONU35+42LX
	35	VOMO35LX	
	42	VOMO42LX	
S	6	VOMO06SX	KONU06+08LX <sup>1)</sup>
	8	VOMO08SX	KONU10+12LX <sup>1)</sup>
	10	VOMO10SX	
	12	VOMO12SX	KONU14+16SX
	14	VOMO14SX	
	16	VOMO16SX	KONU20+25SX
	20	VOMO20SX	
	25	VOMO25SX	KONU30+38SX
	30	VOMO30SX	
	38	VOMO38SX	

1) Cone gauges for tube o.d.6 to 12 mm are identical in series L and S.



## Assembly tooling

### KONU – Cone gauge for EO/EO-2 tube connections

Cone gauges are essential for monitoring wear on pre-assembly tools like VOMO, MOK or MOS.

KONU must be regularly used to prevent fitting failures caused by worn out or damaged tools (DIN 3859-2: max. each 50th assembly).

For proper use see EO assembly instructions.



#### Specifications:

Material: hardened tool steel

Sizes: 4 LL – 12 LL,  
6 L – 42 L,  
6 S – 38 S  
(Sizes 6 L – 12 L  
are identical to 6 S – 12 S)

#### Features, advantages and benefits of cone gauges:

- Special** – KONU are high precision gauges specifically designed and manufactured to match EO standards.
- Practical** – For easy handling and less inventory, each KONU gauge is suitable for two sizes.
- ISO 9001** – Simple but effective method to assure ISO 9001 specification for monitoring tools.
- Maintenance tool** – A leaking fitting can be easily checked and replaced if worn-out.

Series	Tube o.d. mm	Cone gauges Order code
LL	4	KONU04+05LLX
	6	KONU06+08LLX
	8	KONU06+08LLX
	10	KONU10+12LLX
L	12	KONU10+12LLX
	6	KONU06+08LX <sup>1)</sup>
	8	KONU06+08LX <sup>1)</sup>
	10	KONU10+12LX <sup>1)</sup>
	12	KONU10+12LX <sup>1)</sup>
	15	KONU15+18LX
	18	KONU15+18LX
S	22	KONU22+28LX
	28	KONU22+28LX
	35	KONU35+42LX
	42	KONU35+42LX
	6	KONU06+08LX <sup>1)</sup>
	8	KONU06+08LX <sup>1)</sup>
	10	KONU10+12LX <sup>1)</sup>
	12	KONU10+12LX <sup>1)</sup>
	14	KONU14+16SX
	16	KONU14+16SX
20	KONU20+25SX	
25	KONU20+25SX	
30	KONU30+38SX	
38	KONU30+38SX	

<sup>1)</sup> Cone gauges for tube o.d. 6 to 12 are identical in series L and S.

### Checklist “depth measurement” for pre-assembly tooling (MOK and VOMO)

Type	T <sub>min</sub>	T <sub>max</sub>	Type	T <sub>min</sub>	T <sub>max</sub>
6-L	6.95	7.05	6-S	6.95	7.05
8-L	6.95	7.05	8-S	6.95	7.05
10-L	6.95	7.05	10-S	7.45	7.55
12-L	6.95	7.05	12-S	7.45	7.55
15-L	6.95	7.05	14-S	7.95	8.05
18-L	7.45	7.55	16-S	8.45	8.55
22-L	7.45	7.55	20-S	10.45	10.55
28-L	7.45	7.55	25-S	11.95	12.05
35-L	10.45	10.55	30-S	13.45	13.55
42-L	10.95	11.05	38-S	15.95	16.05

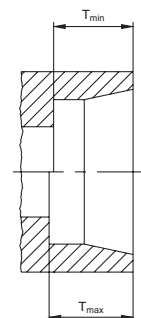

## Distance Gauge for Assembly AKL



### Distance Gauges AKL

Distance gauges AKL are suitable for checking the pre-assembly result of Progressive Rings PSR. They are used on pre-assembled tubes before final installation. The green LED lights up, when none of the following failures is detected:

- Excessive wear of preassembly tools MOK
- Excessive assembly force / pressure setting
- Tube end by far not bottomed in assembly tool MOK.

Therefore, assembly check by cone gauge KONU can be void. Use of distance gauges AKL does not replace the check of the bite (visible collar in front of Progressive Ring).

### Specification

Function:	Distance gauge with LED indication
For checking of:	Machine pre-assembly of Parker EO Progressive Ring PSR
Series:	LL/L/S
Tube-OD:	4–38/42mm
Dimensions:	Length: approx. 130–160mm Front diameter: approx. 30–52 mm
Power:	2 x Battery AA – Mignon – LR6 (included)
Scope of supply:	Distance gauge with LED indication, batteries, master piece and instructions in a plastic case

### Ordering

Size	Order code	Size	Order code	Size	Order code
04-LL	AKL04LL	10-L	AKL10L	10-S	AKL10S
06-LL	AKL06LL	12-L	AKL12L	12-S	AKL12S
08-LL	AKL08LL	15-L	AKL15L	14-S	AKL14S
10-LL	AKL10LL	18-L	AKL18L	16-S	AKL16S
12-LL	AKL12LL	22-L	AKL22L	20-S	AKL20S
06-L/S	AKL06LS	28-L	AKL28L	25-S	AKL25S
08-L/S	AKL08LS	25-L	AKL35L	30-S	AKL30S
		42-L	AKL42L	38-S	AKL38S

### Features, Advantages & Benefits of distance gauge AKL

1. Clear – In contrast to the visual evaluation, the simple good/bad decision is obvious, even for less experienced operators.
2. Economical – The distance gauges AKL are fast in application. The production process is not slowed down noticeably compared with other testing methods.
3. Result-oriented – In the comparison to examining the tools with the AKL teachings the assembly result is examined. Thus also the failure opportunity “Tube by far not bottomed” is detected.
4. Practical – The gauges are light, handy, easy, and can be fastened with an eye. Standard batteries are used, so that a long life span is reached.
5. Safe – The measuring head consists of high-grade steel and is not adjustable or detachable. A master piece for regular functional testing is shipped with each AKL gauge.
6. Innovative – For customers of prefabricated hydraulic tubes, so far it was not easy to inspect the assembly quality of incoming goods. Thus incorrect assemblies, which are caused by use of worn pre-assembly tools, remained often undiscovered. With the distance gauges AKL an efficient and effective inspection of incoming goods can be accomplished, allowing pro-active quality management together with the tube supplier.

### Limitations

- Distance gauges AKL are suitable only for the inspection of machine pre-assembly. After final tightening of the connection, a failure might be indicated, even if the Progressive Ring was properly assembled by the pre-assembly machine.
- Distance gauges AKL are designed for the use with Progressive Rings PSR. Parker does not take responsibility for the function with other bite type fittings. Distance gauges AKL are not suitable for

checking EO2 and EO2-FORM connections.

- Use of distance gauges AKL does not replace the check of the bite (visible collar in front of Progressive Ring).

### Function

Distance gauges AKL are suitable for checking the effect of worn tools on preassembly result of Progressive Rings PSR. They are used on pre-assembled tubes before final installation. The distance gauges AKL particularly detects the position of the Progressive Ring PSR in relation to the tube end. Shining of the green LED indicates that the assembly cone can be further used. Flicker of the green LED is quite possible, since the installed pipe in the gauge can have some clearance. If the wear of the assembly tool reaches 0,1 mm on the cone, the LED shines no longer and indicates that the tool is worn. These defective tube assemblies must not be installed and the worn assembly tool must be replaced. The inspection has to take place regularly, at the latest after 50 assemblies. Then, assembly tool check by cone gauge KONU can be void.

### Operation

- Shining of the green LED indicates that the assembly cone can be further used
- If the LED doesn't shine, the assembly must not be used



### Applications

- Mass production of hydraulic tube assemblies for mobile hydraulics, automotive and agricultural vehicles
- Commercial tube manipulators for hydraulic tube assemblies
- Inspection of incoming tube assemblies at the final installation plant

# Manual assembly devices for EO/EO-2 tube connections

## Machine selection guide

Manual assembly devices are available to reduce assembly time and effort. High assembly quality and consistency assures reliable fitting performance. EO assembly devices are manually operated and do not need any external power supply.

Due to the low weight, easy handling and simple but reliable design, the EO assembly devices are the ideal tool for tube preparation of small quantities.



For efficient mass production, manual devices are not suitable, therefore EOMAT machines are recommended.

### Features, advantages and benefits

- 1. Flexible** – Manual assembly devices are portable and do not need any power supply. Therefore they are ideal for on-site tube assembly, repair and plant maintenance.
- 2. Economic** – Manual assembly devices close the gap in between manual fitting pre-assembly in a vice and the Eomat technology. The devices contribute to save time and effort in bite type assembly. The little investment pays back immediately.
- 3. Controlled assembly** – After pre-assembly, the tube joint can be easily inspected before final installation. Therefore, this mandatory step in fitting assembly is less likely to be forgotten.

- 4. Special** – Each device has been especially developed for the efficient use in a certain application. The HVM-B is a handy tool for the quick pre-assembly of EO Progressive rings onto soft steel tube. The EO-KARRYMAT is a real problem solver when it comes to on-site assembly of medium to large EO-Progressive rings and EO-2 fittings onto steel and stainless steel tube.

### How to select the ideal assembly device for your application:

	HVM-B 	EO-KARRYMAT 
<b>Assembly method</b> EO-2: PSR/DPR/D: Triple-Lok®:	not suitable Stroke controlled not suitable	Pressure controlled Pressure controlled not suitable
<b>Tube specification</b> Material: Outside diameter/mm: Wall thickness:	Steel 4–15 mm no limitation	Steel, Stainless Steel 6–42 mm no limitation
<b>Tool specification</b>	Special assembly cones MOSI and plates HL	Standard assembly cones MOK and plates GHP
<b>Operation drive</b>	Lever with eccentric cam	Handpump
<b>Process control</b>	Assembly stroke determined by tool geometry	Pressure control according to selection chart
<b>Preassembly is equal to</b> EO-2: PSR: D/DPR:	– 1 turn 1 turn	Gap closed 1½ turn 1¼ turn
<b>Performance</b> Overall cycle time: Economic production quantity:	10 secs. max. 50 assemblies per day	30–60 secs. max. 50 assemblies per day
<b>Application</b>	Simple tool for quick pre-assembly of small dimension EO-Progressive rings onto steel tubes	Most efficient for one-site assembly of medium to large DPR- and EO-2 connections onto any suitable tube material. Repair jobs and hydraulic services



## HVM-B Pre-assembly tool

This pre-installation tool is a simple tool for a quick and safe pre-assembly of EO-Progressive Stop Ring/Progressive ring. The tool is very handy and can be used at any site provided a vice is available. Suitable for LL, L and S series and tube sizes from 4 to 15 mm O.D.

**Attention:**

- ⚠ **Not suitable for EO-2 assembly.**
- ⚠ **Not suitable for stainless steel progressive ring assembly.**
- ⚠ **Final assembly of 1/2 turn in fitting body required.**
- ⚠ **Not suitable for tube OD larger 15 mm**

**Specifications:**

For pre-assembly of: EO Progressive Stop Ring (PSR)/Progressive Ring (DPR)

Pre-assembly equals: 1 turn of nut

**For assembly check and fitting installation see assembly instructions chapter E.**

Tube O.D.: 4 to 15 mm

Series: LL, L and S

Tube and

fitting material: Steel

Weight: approx. 7.0 kg (without tools)

**Features, advantages and benefits of pre-assembly tool:**

1. **Special** – HVM-B is designed and manufactured to match EO-DPR standards.
2. **Vice mounted** – For easy workshop use, the HVM-B can be clamped into any vice.
3. **Flexible** – A HVM-B can be used anywhere to assure safe fitting assembly – even at assembly sites where EOMAT technology is not available.
4. **Efficient** – There is no doubt that HVM-B-presetting contributes to save time and effort in bite-type assembly. The small investment pays back immediately.

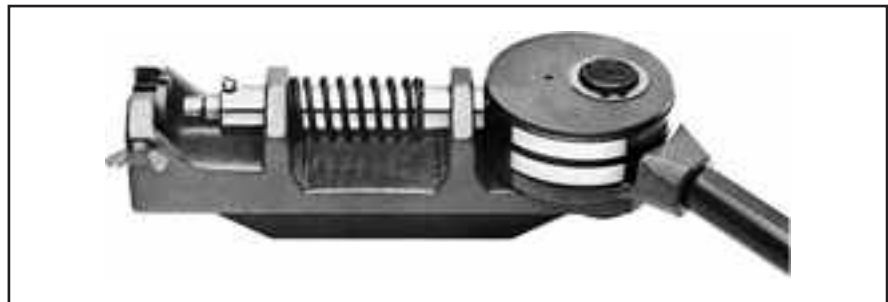

Type	Order code
HVM-B Pre-assembly tool device without tools	HVMBKPLX

Series	Tube o.d. mm	Tube location plate Order code	Assembly cone Order code	Cone gauge Order code
LL	4	HL04X	MOSI04LLX	KONU04+05LLX
	6	HL06X	MOSI06LLX	KONU06+08LLX
	8	HL08X	MOSI08LLX	
	10	HL10X	MOSI10LLX	KONU10+12LLX
	12	HL12X	MOSI12LLX	
L	6	HL06X	MOSI06LX	KONU06+08L/X <sup>1)</sup>
	8	HL08X	MOSI08LX	
	10	HL10X	MOSI10LX	KONU10+12L/X <sup>1)</sup>
	12	HL12X	MOSI12LX	
	15	HL15X	MOSI15LX	KONU15+18L/X
S	6	HL06X	MOSI06SX	KONU06+08L/X <sup>1)</sup>
	8	HL08X	MOSI08SX	
	10	HL10X	MOSI10SX	KONU10+12L/X <sup>1)</sup>
	12	HL12X	MOSI12SX	
	14	HL14X	MOSI14SX	KONU14+16SX

1) Cone gauges for tube o.d. 6 to 12 are identical in series L and S.



### HVM-B Pre-assembly tool

1



2



3



4



5



#### How to use

- Clamp HVM-B into vice.
- Select required assembly cone (MOS-I) and insert.
- The assembly cones are marked with tube O.D. and series (e.g. 10-L).

- Insert the tube location plate – HL – of corresponding size and fasten with screw.
- The tube location plates are marked with tube O.D. (e.g. "10").

- Slip nut "M" and Progressive Stop Ring PSR/Progressive ring "DPR" (or cutting ring "D") over tube end and insert into pre-assembly tool.
- Nut position must be in front of tube location plate – HL – !

- Hold tube against stop in the assembly cone.

- Pull lever to turn the eccentric cam (Pre-assembly).

#### Attention

△ For assembly check and final assembly see PSR/DPR instructions.

#### Attention:

△ At final assembly nut must be tightened by  $\frac{1}{2}$  turn.

**EO-KARRYMAT portable pre-assembly device for EO tube connections**



Type	Order code
EO-KARRYMAT assembly device complete device including handpump and carrying case, including operation manual. Tools (assembly cone MOK and backing plate GHP) must be ordered separately.	EOKARRYMAT
Promotion leaflet UK/DE	4044-DE/UK
Separate operating manual UK/DE/FR/IT	4044-T
<b>Spare parts</b>	
Handpump	82C-2HP
Pressure gauge	EOKARRYMAT/MANO
Pressure chart sticker	EOKARRYMAT/CHART
Cover hinge	EOKARRYMAT/HINGE
Assembly head	EOKARRYMAT/BLOCK

The EO-KARRYMAT is a dependable device for safe and efficient bite-type presetting. It allows pre-assembly of even large dimension steel and stainless steel tube at assembly sites where EOMAT technology is not available.

The EO-KARRYMAT consists of a hydraulic drive and a handpump. The hydraulic assembly pressure can be read on a gauge. The EO-KARRYMAT comes as one unit with all components firmly attached to a practical carrying frame.

**Specifications:**

For pre-assembly of: EO PSR/DPR and EO-2

Pre-assembly equals:  
 EO Progressive Stop Ring (PSR): 1½ turns of nut  
 EO Progressive ring (DPR): 1¼ turns of nut  
 EO-2 "Gap closed"

⚠ **For assembly check and fitting installation see assembly instructions chapter E.**

Tube O.D.: 6 to 42 mm  
 Series: L and S  
 Tube and fitting material: Steel and stainless steel  
 Weight: approx. 28 kg  
 Economic production quantity: max. 100 assemblies per day  
 Oil: HLP23-1.22 (filled before delivery)





**Features, advantages and benefits of EO-KARRYMAT:**

- 1. Ideal** – Weighing 28 kg, the EO-KARRYMAT is portable and does not need any power supply. Therefore the EO-KARRYMAT is the ideal tool for on-site tube assembly, repair and plant maintenance.
- 2. Economic** – The EO-KARRYMAT closes the gap in between manual fitting pre-assembly in a vice and the EOMAT technology. EO-KARRYMAT assembly is far less hard work as manual assembly but it achieves the dependent assembly result of the EOMAT assembly machine.
- 3. "Must" for stainless steel** – As direct assembly of stainless steel tubes in bite type fittings results in failure, a special pre-assembly process is mandatory according to ISO 8483 / DIN 3859 and all manufacturers instructions. The EO-KARRYMAT fulfils this requirement.
- 4. Dependable** – The use of the EO-KARRYMAT is far less demanding than manual fitting assembly using wrenches. It helps to prevent failures caused by insufficient fitting assembly which is most critical on large dimension steel and stainless steel tube.
- 5. Controlled assembly** – After pre-assembly, the tube joint can be easily inspected before final assembly. Therefore, this mandatory step in fitting assembly is less likely to be forgotten.
- 6. Special** – The EO-KARRYMAT has been especially developed for the efficient on-site assembly of EO Progressive ring and EO-2 fittings. The

tools are designed according to a new EO-patent which allows safe assembly of even large dimension steel and stainless steel tubes without excessive hard work.

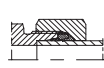
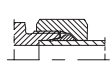
**The applications:**

- Repair workshops
- Mobile repair service
- Plant maintenance in process engineering, paper production, power plants, offshore exploration, industrial production
- On-site assembly of tubing systems

Tube O.D.	EO-2	PSR/DPR
 Ø [mm]	 P [bar]	 P [bar]
6	45	30
8	55	40
10	65	50
12	75	60
14	95	70
15	95	70
16	110	90
18	110	90
20	160	120
22	120	110
25	210	160
28	160	140
30	300	200
35	250	180
38	350	280
42	300	230
 Installation	 min. 60° max. 90°	 ~ 30°



# Assembly machines for EO/EO-2 and Triple-Lok®

## Machine selection guide

EOMAT assembly is much more cost efficient than manual assembly of EO-fittings. Assembly time and effort are greatly reduced. Proper and consistent pre-assembly support safe and leakfree fitting performance.

EOMAT machines are specifically designed to match EO-2, EO PSR/DPR rings and Triple Lok® standards. Assembly is achieved with high precision and repeatability.

EOMAT machines are available in several versions to serve individual applications. All machines are designed for reliable workshop use even under severe construction site working conditions. Tool handling and machine operation are simple.

How to select the ideal EOMAT machine for your application:

### Features, advantage and benefits:

- 1. Universal** – Assembly of EO-2, EO PSR/DPR rings and 37° flaring for Triple-Lok® can be done with just 1 machine.
- 2. Efficient** – With a cycle time of some 12 to 15 seconds the EOMAT machine greatly saves assembly time and effort. The investment pays back quickly.
- 3. Safe** – Proper pre-assembly greatly reduces the danger of leaking fittings or even hazardous tube blow out.

- 4. Strong** – Even 37° flaring of larger sized stainless steel tube is done within few seconds.
- 5. Flexible** – All tube dimensions from 6 to 42 mm can be used. All common tube materials are covered, even plastic tube (EO-2 and PSR/DPR only).
- 6. Marking notch** – A special ridge makes a circular mark onto the tube end to verify that it was properly bottomed at assembly. Failures caused by improper tube cutting or bottoming in MOK can be recognised before final installation.
- 7. Reliable** – For more than 20 years, hundreds of EOMAT machines have operated under heavy duty workshop conditions.

## Selection chart EOMAT Pre assembly and Flaring machines

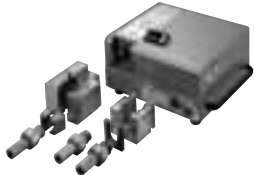
	EOMAT ECO 	EOMAT UNI 
<b>Assembly method:</b> EO-2 D/PSR/DPR Triple-Lok®	Pressure controlled Pressure controlled –	Pressure controlled Pressure controlled Conventional 37° flaring
<b>Tube specification:</b> <b>Material</b> <b>Outside diameter</b> <b>Wall thickness:</b> EO-2/PSR/DPR Triple Lok®	Steel, Stainless Steel 6–42 mm No limitation not applicable	Steel, Stainless Steel 6–42 mm No limitation 6x1 to 38x4 or 42x3 mm (Tube O.D. x wall thickness)
<b>Operation:</b> <b>Setting</b>  <b>Process control</b>  <b>Memory function</b> <b>Oil level control</b> <b>Oil temperature control</b> <b>Foot operating switch</b>	Manual pressure adjustment according to selection chart Depending on: Assembly type; Tube dimension; Tube material Pressure gauge No No No Not available	Manual pressure adjustment according to selection chart Depending on: Assembly type; Tube dimension; Tube material Pressure gauge No Visual control No Not available
<b>Performance</b> <b>Overall cycle time (sec.):</b> EO-2 presetting PSR/DPR presetting 37° flaring  <b>Economic production quantity:</b> <b>Continuous operating:</b> <b>Weight</b>	1 Phase/230 V  20 25 –  max. 100 assemblies per day 80 % approx. 30 kg	1 Phase/230 V  12 15 15  max. 300 assemblies per day 80 % approx. 66 kg
<b>Application</b>	<b>Portable machine for repair and workshops</b>	<b>Universal assembly machine for workshop</b>

**EOMAT ECO Mobile assembly machine for EO hydraulic fittings**



**The EOMAT ECO is a portable machine for the assembly of EO-2 and EO Progressive Ring fittings.**

This electro-hydraulic unit is simple to operate; the assembly pressure is set on the digital display. The equipment is simple to use, robust and easy to move.

The EOMAT ECO is an ideal piece of equipment for hydraulic service engineers.

Tube diameters: 6 to 42 mm  
 Series: L and S  
 Speed: working stroke 15 to 20 secs, total cycle time approx. 20 to 25 secs  
 Dimensions: 750 x 360 x 300 mm  
 Weight: 30 kg  
 Electrical: 230V 1-phase  
 power rating: 50 Hz 700 W

**Operation:**

for detailed assembly instructions, see our fittings technology technical handbook, chapter E. For safety information, see machine operating manual.

1. Install assembly cone and backing plate

2. Set the setting pressure on the display in accordance with the chart
3. Insert tube complete with nut and ring
4. Operate START button and keep pressed
5. Hold the tube firmly during the assembly operation and press against the stop
6. The assembly operation is complete when the cylinder has travelled back to its starting position
7. Assembly inspection and final assembly should proceed in accordance with the operating manual.

**Technical data**

Application: assembly of Parker EO2 and PSR Progressive Ring fittings  
 assembly of cutting ring fittings to DIN EN ISO 8434-1  
 Process: pressure-controlled press operation through assembly tools  
 Drive: electro-hydraulic  
 Assembly corresponds to: EO2: gap closed PSR: 11/2 turns of the nut  
 Tube material: steel and stainless steel

**Performance:**

Economic production quantity: max. 100 assemblies per day.

Type	Order code
EOMAT ECO basic machine Ready to operate, including operating manual Without tools	EOMATECO230V
Bulletin	4046 via Parker catalogue service EMDC
Operating manual UK/DE/FR/IT/ES	EOMATECO/MANUAL
Pressure chart sticker	EOMATECO/CHART

Setting pressures



# EOMAT ECO



Tube-O.D.



Ø (mm)

EO-2

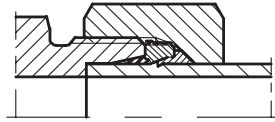

P (bar)

PSR/DPR

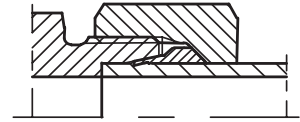

P (bar)

6	25	20
8	35	25
10	40	35
12	45	40
14	60	45
15	60	45
16	70	60
18	70	60
20	105	75
22	75	70
25	135	105
28	105	90
30	190	130
35	160	115
38	210	180
42	190	145
	<p>Installation</p> <p>min. 60° max. 90°</p>	<p>Installation</p> <p>~ 30°</p>

The stated values are guidelines. The results of pre-assembly and tube flaring respectively should therefore be thoroughly checked.

## EOMAT UNI assembly and flaring machine

### General

The EOMAT UNI is an electro-hydraulic machine for the assembly of:

#### EO-2

#### EO PSR/DPR and Triple-Lok® 37° flared tube fittings.

Compared to manual assembly it greatly reduces assembly time, effort and cost and also guarantees leakfree performance of constant high-quality fitting assemblies.

Common tube materials such as steel (ST 37.4 NBK, ST 52.4 NBK), stainless steel (1.4571/1.4541/316Ti or similar) and copper can be pre-assembled.

The tool range covers all metric tube sizes from 4 to 42 mm outer diameter. The required operating pressure is variable and set at the LED-Display. The unit may therefore be used for a variety of different applications. The tooling for either EO-2/PSR/DPR pre-assembly or tube flaring may be manually replaced, without the use of tools.

### Technical data

Tube diameters: 6–42 mm

Series: L and S

Oil:

Esso Nuto H 32 or equal, 3.5L

(Reference oil change, see label on unit)

Operating pressure:

Variable from 15 to 200 bar

Dimensions:

Width 535 mm, height 285 mm, depth

515 mm

### Performance:

Overall cycletime: 12–15 sec.

Economic production quantity:

max. 100 assemblies per day

Hydraulic pump:

1.2 kW – 3.7 l/min

Electrical connection:

220–240 V/ 1~ / 50 Hz / 9.5 A

Connection cable:

5 m – Earth plug

Weight: 66 kg

We reserve the right to make modifications in the course of further technical development.

### Features, advantages and benefits:

- 1. Universal** – Assembly of EO-2, EO-PSR/DPR and 37° flaring for Triple-Lok® can be done with just 1 machine.
- 2. Efficient** – With a cycle time of some 15 seconds the EOMAT UNI greatly saves assembly time and effort. The investment pays back quickly.
- 3. Safe** – Proper pre-assembly greatly reduces the danger of leaking fittings or even hazardous tube blow out.
- 4. Strong** – Even 37° flaring of larger sized stainless steel tube is done within few seconds.
- 5. Flexible** – All tube dimensions from 4 to 42 mm can be pre-assembled. All common tube materials are covered.
- 6. Workshop tool** – At 66 kg, the EOMAT UNI can be brought to an assembly site.
- 7. Marking ridge** – All MOK tools feature a special ridge in the bottom surface which is designed to make a circular groove into the tube-end at assembly. No mark indicates that the tube-end has not been properly bottomed at assembly.
- 8. Reliable** – For more than 20 years, hundreds of machines are operated under heavy duty workshop conditions.

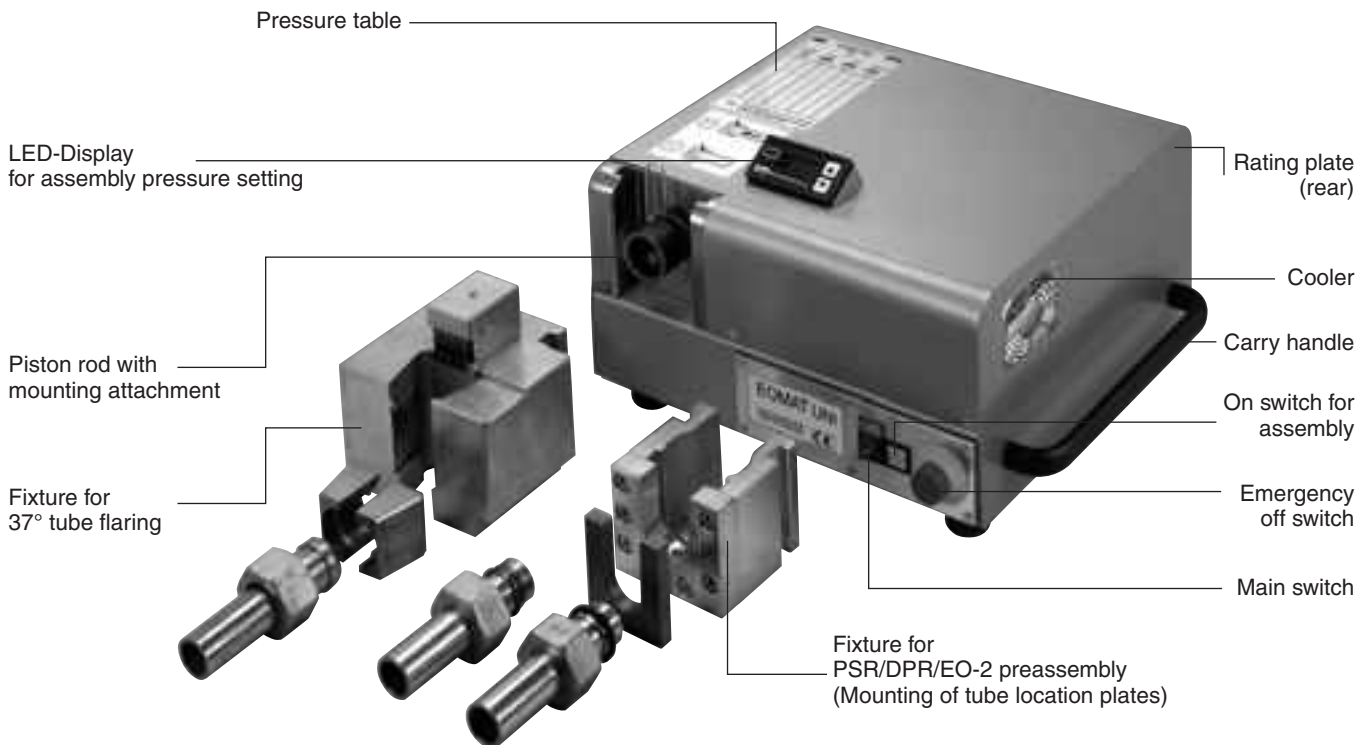

### EOMAT UNI assembly and flaring machine

#### Basic operation for EO-2

##### Functional nuts

See EO-2 instructions for fitting assembly

1. Adjust EO-2 pressure according to chart (A)
2. Insert the pre-assembly fixture in the tool mounting weight approx. 5.5 kg).
3. Select the assembly cone (MOK) and backing plate (GHP) in accordance with the tube size and type.
4. Place and lock the assembly cone in the tool holder. Place the backing plate in the slot in the fixture.
5. Slide the EO-2 functional nut onto the tube, which has been cut off square and deburred.
6. Place the tube with the EO-2 functional nut in the pre-assembly fixture between backing plate and assembly cone.
7. Press the tube against the stop in the assembly cone. Hold the tube in this position. Press and hold the start button until the pre-assembly process is complete.
8. Take the assembled tube connection out of the location plate. See EO-2 assembly instruction (chapter E) for assembly check and installation instructions.
9. Check assembly result before final installation.

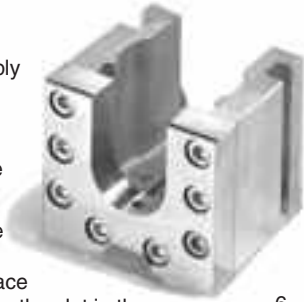

#### Basic operation for EO PSR/DPR ferrules

See PSR/DPR instructions for fitting assembly

1. Adjust PSR/DPR pressure according to chart (A)
2. Insert the pre-assembly fixture in the tool mounting (weight approx. 5.5 kg).
3. Select the assembly cone (MOK) and backing plate (GHP) in accordance with the tube size and type. Check the assembly cone using a cone gauge.
4. Place the assembly cone in the tool holder. Place the backing plate in the slot in the fixture.
5. Oil the ring, nut and assembly cone.
6. Slide the nut and ring onto the tube, which has been cut off square and deburred.
7. Place the tube with nut and progressive ring or cutting ring in the pre-assembly fixture between backing plate and assembly cone.
8. Press the tube against the stop in the assembly cone. Hold the tube in this position. Press and hold the start button until the pre-assembly process is completed.
9. Take the pre-assembled tube out of the backing plate. See EO PSR/DPR assembly instruction (chapter E) for assembly check and installation instructions.
10. Check assembly result before final installation.

#### Basic operation for 37° tube flaring

See Triple-Lok® instructions for fitting assembly

1. Adjust Triple-Lok® pressure according to chart (A)
2. Insert the tube flaring fixture in the tool mounting (weight approx. 19.5 kg).
3. Lubricate the flaring pin.
4. Insert the flaring die set corresponding to the tube size.
5. Push the nut and support sleeve onto the tube.
6. Push the tube through the flaring die hole to the stop plate. To prevent misalignment, longer tubes are to be supported during the flaring process.
7. Press the start button (or right-hand foot switch) and hold until the display reads "RELEASE START BUTTON". The flaring procedure is completed.
8. Lift the tube with the flaring die upwards out of the fixture.
9. To release the tube, place the flaring die set in the opening provided in the fixture and tilt the tube to one side.
10. Check assembly result before final installation.



#### Important!

Only proceed with pre-assembly when a tube with nut and cutting ring has been placed in the fixture (failure to observe this can result in damage to the tools). Longer tubes are to be suitably supported during pre-assembly. The assembly cones are to be regularly checked for correct dimensions using the cone gauge and should be replaced when necessary.

**Caution: do not reach into the working area of the pre-assembly fixture while it is operating!**

#### Important!









Do not drive the flaring pin into the flaring die without a tube in position. The roughened surface of the flaring die must be absolutely free of oil and grease to prevent the tube from slipping.

**Caution: do not reach into the working area of the flaring fixture while it is operating!**

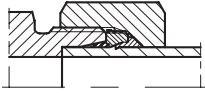
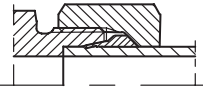
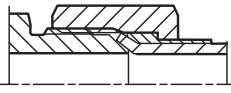

**EOMAT UNI assembly and flaring machine**

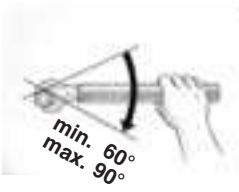
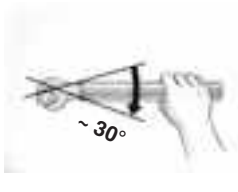
Pressure setting chart A

		<h1>EOMAT UNI</h1> 			
<b>Tube-O.D.</b>  Ø (mm)	<b>EO-2</b>  P (bar)	<b>PSR/DPR</b>  P (bar)	<b>Triple-Lok®</b>  P (bar)		
6	30	25	20		
8	35	30	25		
10	45	35	35		
12	50	40	35		
14	60	50	45		
15	60	50	60		
16	70	55	60		
18	70	65	70		
20	100	80	95		
22	80	75	95		
25	130	100	105		
28	100	90	125		
30	180	125	135		
35	150	110	155		
38	200	170	165		
42	180	140	185		
 Installation		 min. 60° max. 90°		 ~ 30°	
		<b>Steel (ST 37.4 NBK, ST 52.4 NBK, ...)</b> <b>Stainless Steel (ST 1.4571, 1.4541, 1.4301, 316 Ti, ...)</b>			

The given values are a guide. The results of pre-assembly and/or tube flaring are therefore always to be checked. For detailed instructions on tube preparation, tool selection, assembly check and final installation see chapter E.



## Assembly tooling

---

### EOMAT UNI assembly and flaring machine

#### Ordering

Type	Order code
EOMAT UNI Basic machine Ready to use, including operation manual Filled with hydraulic oil Without EO assembly fixture/Flaring fixture Without tools for EO-assembly/37° flaring Basic machine 230 V, 1 Phase, 50 Hz	EOMATUNI230V
Fixture for PSR/DPR/EO-2 assembly	EOMATSCHNEIDRX
37° Flaring fixture for Triple-Lok®	EOMATBOERDELBX
EOMAT UNI promotion leaflet UK	4042/UK
EOMAT UNI promotion leaflet DE	4042/DE
EOMAT UNI operating manual UK/DE/FR/IT	EOMATUNI/MANUAL

Assembly fixtures, tools, cone gauges, and lubricant must be ordered separately

**Assembly tools for PSR/DPR/EO2 see page H19–H20.**

**37° flaring tools for Triple-Lok® see page H29.**

#### Spare parts

Type	Order code
Fixing clip for MOK	EOMAT/CLIP
37° flaring pin	EOMAT/FLAREPIN
O-ring for flaring pin	EOMAT/0212500
Tube stop assembly for flaring block	EOMAT/0213800
Pressure chart sticker	EOMATUNI/CHART

EO PSR/DPR and EO-2 assembly tools for EOMAT/EO-KARRYMAT



Assembly cone MOK



Tube locating plate GHP



Cone gauge KONU for MOK



Assembly fixture must be installed on EOMAT UNI II/III

Size		Order code				
Series	Tube-O.D.	Assembly cones for EO PSR/DPR MOK	Assembly cones for EO2 MOK	Backing plates GHP	Distance control gauges AKL	Cone gauges KONU
<b>LL<sup>3</sup></b>	4	MOK04LLX	as MOK for PSR/DPR	GHP04X		KONU04+05LLX
	6	MOK06LLX		GHP06X		KONU06+08LLX
	8	MOK08LLX		GHP08X		KONU10+12LLX
	10	MOK10LLX		GHP10X		
	12	MOK12LLX		GHP12X		
<b>L</b>	6	MOK06LX	as MOK for PSR/DPR	GHP06X <sup>1</sup>	AKL06LS	KONU06+08L/SX <sup>1</sup>
	8	MOK08LX		GHP08X <sup>1</sup>	AKL08LS	
	10	MOK10LX		GHP10X <sup>1</sup>	AKL10L	KONU10+12L/SX <sup>1</sup>
	12	MOK12LX		GHP12X <sup>1</sup>	AKL12L	
	15	MOK15LX		GHP15X	AKL15L	KONU15+18LX
	18	MOK18LX	MOKEO228LX MOKEO235LX MOKEO242LX	GHP18X	AKL18L	
	22	MOK22LX		GHP22X	AKL22L	KONU22+28LX
	28	MOK28LX		GHP28X	AKL28L	
	35	MOK35LX		GHP35X <sup>2</sup>	AKL35L	KONU35+42LX
	42	MOK42LX		GHP42X <sup>2</sup>	AKL42L	
<b>S</b>	6	MOK06SX	as MOK for PSR/DPR	GHP06X <sup>1</sup>	AKL06LS	KONU06+08L/SX <sup>1</sup>
	8	MOK08SX		GHP08X <sup>1</sup>	AKL08LS	
	10	MOK10SX		GHP10X <sup>1</sup>	AKL10S	KONU10+12L/SX <sup>1</sup>
	12	MOK12SX		GHP12X <sup>1</sup>	AKL12S	
	14	MOK14SX		GHP14X	AKL14S	KONU14+16SX
	16	MOK16SX	MOKEO220SX MOKEO225SX MOKEO230SX MOKEO238SX	GHP16X	AKL16S	
	20	MOK20SX		GHP20X	AKL20S	KONU20+25SX
	25	MOK25SX		GHP25X	AKL25S	
	30	MOK30SX		GHP30X	AKL30S	KONU30+38SX
	38	MOK38SX		GHP38X	AKL38S	

Flaring tools see KARRYFLARE

1. Backing plates, cone gauges and flaring die sets for series L and S for tube outer diameter 6, 8, 10 and 12 are the same.
2. **Note:** For the assembly of EO-2 functional nuts FM 35L and FM42L the two-part backing plates GHP 35 and 42 must be used.
3. Assembly tools for LL-series for EOMAT UNI on request.
4. Special MOK for easy tube insertion.

**Tool mounting rack**

Practical rack for storing 10 pieces each assembly cone MOK and backing plate GHP.

Type	Order code
Tool mounting rack for GHP and MOK	EOMATWEKZGAUFN.X



**Tool lifetime**

Assembly tools are subject of wear and must be regularly (max. 50 assemblies) cleaned and checked (Checking instructions see chapter E). Worn out tools can cause dangerous assembly failures and must be replaced in time. Average tool lifetime is approx. 5000 cycles when properly used. Maximum lifetime can be achieved by following factors:

- Regular cleaning and checking
- Clean and corrosion-protected storage
- Proper de-burring and cleaning of tube end
- Proper tool selection and operation
- Use of specified lubricant



## Assembly tooling

### Ferulok assembly tools for EOMAT/EO-KARRYMAT



Assembly cone



Back-up plate

Size		Order code	
Dash size	Tube-O.D. inch	Assembly cone	Back-up plate
4	1/4	975867-4	976521-4
6	3/8	975867-6	976521-6
8	1/2	975867-8	976521-8
10	5/8	975867-10	976521-10
12	3/4	975867-12	976521-12
14	7/8	975867-14	976521-14
16	1	975867-16	976521-16
20	1 1/4	975867-20	976521-20
24	1 1/2	975867-24	976521-24
32	2	975867-32	976521-32

Assembly tools for inch tube bite type FERULOK.  
FERULOK fittings see TFD US-Catalogue 4300.  
Machine setting according to correspondant size EO DPR.

## EO2-FORM F3 WorkCenter

The EO2-FORM F3 machine is designed to cold-form hydraulic tube economically for EO2-FORM connections. During this process, the tube end is compressed in-between forming dies. This results in a special tube profile which matches the genuine EO-2 fitting components. The use of EO-2 seals provides leakfree performance and full interchangeability to the complete Ermeto Original product range according to DIN EN ISO 8434-1/ DIN 2353.

EO2-FORM is an attractive solution for high pressure tube connections that combines the advantages of welding, flaring and the proven EO-2 technology. The rigidity and low tightening torques of a weld connection are achieved by the unique cold forming process. Unlike other forming systems, the deformation for EO2-FORM connections is relatively small and much more a compression process than forming. This results in a high strength of the mechanical connection. During fitting assembly, standard EO-2 seals are fitted onto the tube end.

The EO-2 seal achieves leak-free performance even under severe working conditions. For easy operation and high efficiency, the EO2-FORM process is completely automated. Manual adjustment of tools or pressure settings is not required. To assure reliable function, the machine has a powerful drive and the tools are made of high-strength material. Tools are available in a

wide range and the short clamping length allows compact tube bends. Special tube treatment, heat or chemicals are not required. Zinc-plated tube can be used.

The EO2-FORM F3 machine is suitable for almost any hydraulic tube material in metric dimensions from 6 mm to 38/42 mm tube OD. Depending on tube dimension and material, the deformation is done in around 10 seconds. Total cycle time is 15 seconds on average. All machine components, including the hydraulic power pack, are integrated into the machine housing. The only external connection is the electrical power supply.

The EO2-FORM F3 machine generation is perfectly designed for practical workshop use. It represents not just a machine but a complete tube forming workcenter. A practical tool compartment inside the machine housing allows orderly and clean tool storage. Additional work-benches or space to store tools are not required. Special handling devices allow quick and easy machine setup and tool change. To allow transportation, the machine is mounted on wheels and provided with special crane and forklift attachments.

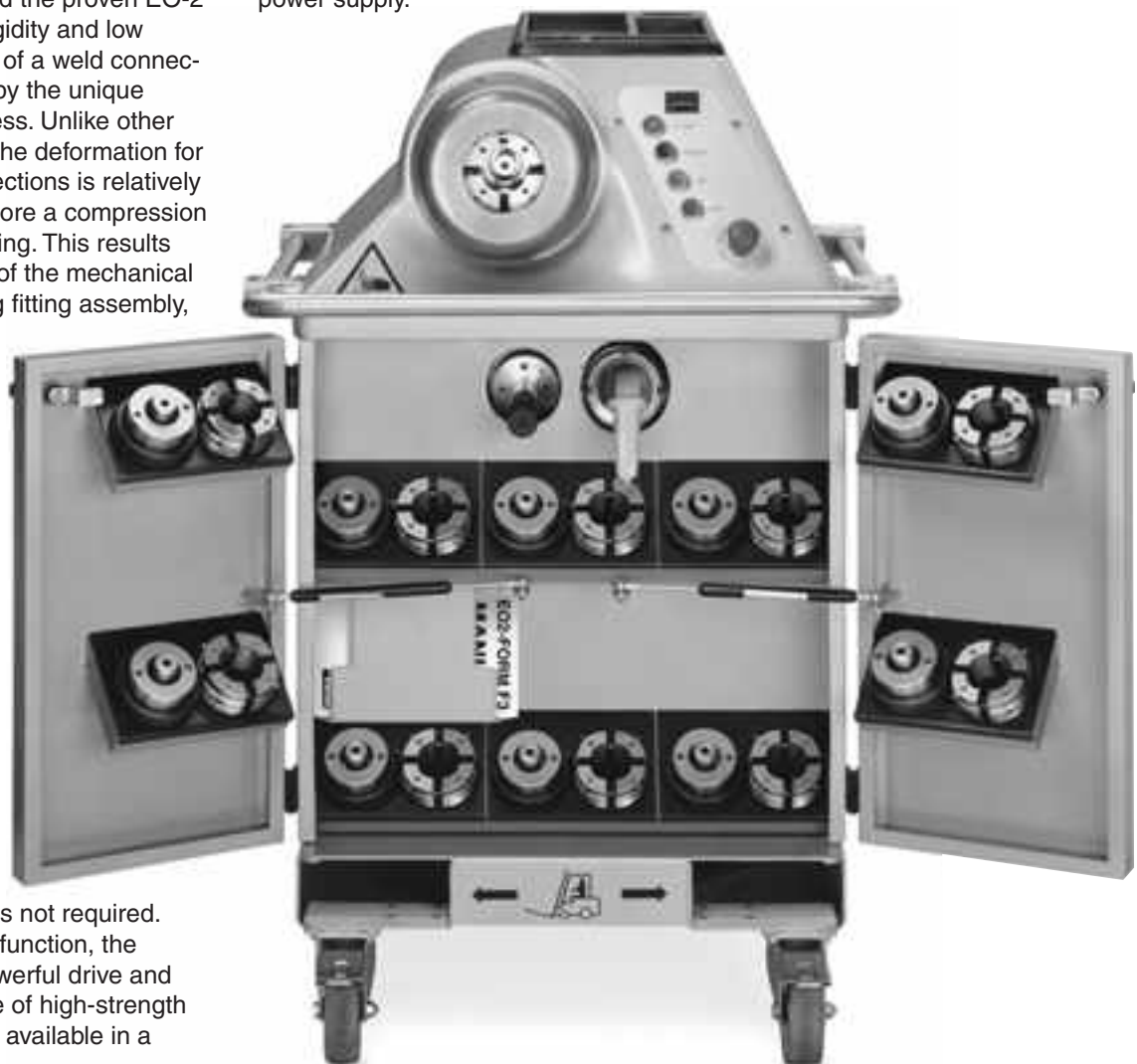

### EO2-FORM F3 WorkCenter

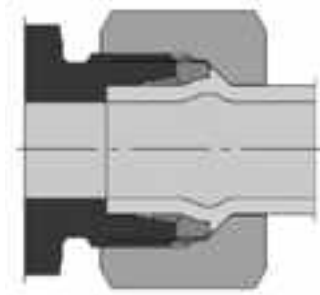

#### Specifications

- Cold-forming of hydraulic tube-ends
- Elastomerically sealed high pressure tube connection using EO-2 seal element
- Suitable for EO tube fittings according to DIN EN ISO 8434-1
- Tube dimensions (tube OD x wall thickness mm)  
steel tube ST37.4: 6x1 to 38x7/42x4/Stainless steel tube 1.4571: 6x1 to 38x5/42x3
- Exotic tube materials, such as CuNiFe or Duplex on request
- Cycle time: 15 to 20 seconds
- Workshop performance (without oil-cooler): max. 100 formings per hour
- Mass production performance with oil-cooler: max. 200 formings per hour
- Standard power supply: 400V 50Hz
- Dimensions: Width closed 650 mm, open 1200 mm, height 1200 mm, depth 750 mm
- Weight: approx. 300 kg

#### Features, advantages and benefits

1. **Process / Product concept** – The EO2-FORM technology is not a stand-alone machine or a new fitting system. It is a product extension of the EO-2 range which has existed since 1993. Exactly the same, proven seal elements are used.
2. **Workcenter concept** – All tools, handling devices, lubricants and the operator manual are well organised inside the machine. Once the doors are opened, the machine turns into a stand-alone workcenter for tube preparation. On the top shelf, there are practical compartments for rules, pens, lubricant and standard EO-boxes with nuts and sealing rings. No additional workbenches or shelves for tooling are required.
3. **Easy operation** – One single START-button is all that needs to be operated to run a forming cycle completely. No “zero position” or “reset” activities have to be performed in-between two forming cycles. For efficient mass production, a foot switch is available. A label on the machine head shows all operation steps in pictograms and all important dimensions in charts.
4. **Easy tool change** – An ergonomic, pistol-like device allows quick and easy change of the one-piece clamping die set without opening the forming head or even touching the tools. Another handle speeds up the setup process of the forming pin in the bayonet mechanism.
5. **Easy handling** – Standard tools and one set of EO2 sealing rings are suitable for all common hydraulic tube dimensions. No special sleeves are required for thin wall or small diameter tube.
6. **Well organised** – All tools and accessories are well organised in a practical compartment inside the machine housing. Nothing gets dirty, lost or confused.
7. **Easy transport** – The machine is equipped with heavy duty wheels so that it can be moved around by one person without hard work or additional equipment. Special attachments for crane and forklift truck transport are standard. A reeling serves as handle, protection and attachment for fixing belts when transported by truck. Tools and all accessories are safely and cleanly stored inside.
8. **Easy logistics** – EO2-FORM uses the same components as EO2. Special sets of nuts and sealing rings can be ordered with one part number (FORM ...). This reduces ordering effort and contributes to achieve availability with optimum inventory.
9. **Stainless steel capabilities** – Forming pins for stainless steel tubes are specially designed for optimum forming results and surface coated for maximum lifetime. All forming pins for stainless steel tube are marked with a blue dot. Clamping dies can be used for both, steel and stainless steel tube.
10. **Approved functional system** – EO2-FORM has been on market for years. It is approved for use in shipbuilding, offshore industry, hydraulic water lock systems, press and crane manufacturing, heavy mobile equipment and general machine building. EO2-FORM is tested and approved from authorities like German Lloyd, DNV or from end-users like Daimler-Chrysler.
11. **Cost saving** – Compared to welding or brazing, EO2-FORM is much less time consuming. Special tube preparation and finishing are not necessary. Cold forming uses only a fraction of the energy needed for brazing or welding.
12. **Superior vibration resistance** – The patented EO2-FORM process achieves a smooth structural transformation of the tube wall. There are no sharp edges or notches to reduce the vibration resistance.
13. **Superior mechanical strength** – The working contact area of the EO2-FORM connection is the flat front surface of the metal support ring which is made of heat-treated, high-strength steel or stainless steel. This provides superior mechanical strength without settling, loosening or need for re-tightening.
14. **Universal** – The EO2-FORM machine can cold-form all common steel and stainless steel tube materials for hydraulic pipework. Even exotic materials such as Cu-NiFe or Duplex can be formed. EO2-FORM tools cover metric tube sizes from 6 to 42 mm OD.
15. **Short tube ends** – The compact clamping device and special dies are suitable for machining complex tube bends.
16. **Noise/energy loss reduction** – The EO2-FORM process results in a smooth inner contour of the tube. Minimum pressure drop, heat and noise is created. No hidden corners allow the accumulation of air, dirt or other sources of trouble.
17. **Clean** – The EO2-FORM process is environmental clean and safe. As no heat is used, hazards from fumes or heat do not occur.
18. **Zinc plated tubing** – The EO2-FORM process allows the use of zinc-plated tubing. The costs of cleaning or painting are saved.
19. **Quality** – Tube clamping and tool functions are fully automated. Proper joint geometry and seal dimensions are achieved by using standard EO-2 sealing rings. Therefore high and consistent quality is achieved without manual adjustment.
20. **Proven Technology** – Since 1993, millions of EO-2 fittings have operated worldwide under heavy duty conditions, providing leak-free hydraulic systems.
21. **No restrictions** – The process allows to use EO-2 elastomeric sealing technology even for applications where bite-type connectors are not permitted by safety standards, for example hydraulic presses, cranes, lifts or ship canal systems locks.

## F3 Forming machine for EO2-FORM high pressure tube connections

### Machine

Type	Order code
Forming machine F3, ready to use, including tool changing devices and operation manual, without tooling Cold-forming of EO2-FORM connections In special transport container Power supply 400V / 50Hz / 3phases Power supply 230V / 50Hz / 3phases	EO2FORMF3400V EO2FORMF3230V
Foot switch	F3/FOOTSWITCH
Oil cooler kit	F3/COOLERKIT
EO2-FORM F3 promotion leaflet UK	4032/UK
EO2-FORM F3 promotion leaflet DE	4032/DE
Operation manual UK/DE/FR/IT	4033

EO2-FORM machines are shipped in a special container which should be kept for all transports to avoid damage.

### Spare parts

Tools	Order code
Tool handling and clamping holder for forming pin	F3/PINHOLDER
Pistol holder for forming die set	F3/DIEHOLDER
Clamping segments for die set	F3/DIECLAMP
Clamping segment spring $\varnothing$ 8mm	F3/DIECLAMPSPRING8
Clamping segment spring $\varnothing$ 12mm	F3/DIECLAMPSPRING12

Machine housing	Order code
Top machine cover	F3/HEADCOVER
Top tray	F3/TOPTRAY
Door lock for tool compartment	F3/DOORLOCK
Door hinge	F3/DOORHINGE
Shock absorber for doors	F3/DOORSRING
Tool tray for inner tool compartment	F3/TOOLTRAYIN
Tool tray for tool compartment in doors	F3/TOOLTRAYDOOR
Die insert for tool tray (use screw M6)	F3/TOOLTRAYDIE
Insert with holder for handling devices	F3/HOLDERTRAY
Plastic guide for forklift (use screw M6)	F3/FORKGUIDE
Front wheel with lock	F3/FRONTWHEEL
Rear wheel	F3/BACKWHEEL
Oil filter	F3/OILFILTER
High pressure hose	F3/HOSE

Sticker	Order code
EO2-FORM F3 door label	F3/STICKERPARKER
Short instructions on side	F3/STICKERINSTRUC
Lubrication on front	F3/STICKERLUB
Crane attachment (1 piece)	F3/STICKERCRANE
Forklift on front	F3/STICKERFORK
Blue dot sticker for stainless steel dies	F3/STICKERBLUEDOT

Operation panel	Order code
Front panel counter	F3/FRONTCOUNTER
"Start" switch (black with symbol)	F3/STARTSWITCH
"Reset" switch (blue)	F3/RESETSWITCH
"ON" switch (green)	F3/ONSWITCH
"OFF" switch (red)	F3/OFFSWITCH
emergency stop switch (red)	F3/STOPSWITCH

Tool components	Order code
Bayonet bolt for forming pin	F3/PINBOLT
Fixing screw for bayonet bolt (M6x16)	F3/PINSCREW
Screw for clamping die segments	F3/DIESCREW
Spring for clamping die segments	F3/DIESPRING 8,12
Outer pin on die set	F3/DIEPIN



Foot switch



Holder for forming pin



Pistol holder for forming die set



Oil cooler kit





Pin for forming pin



Pin for clamping die set



## F3 Forming machine for EO2-FORM high pressure tube connections

 <b>Clamping die set MF3EO-2</b>			 <b>Forming pin BF3EO-2</b>	
Tube O.D. Ø	Clamping dies for steel and stainless steel tubes Order code	Ø × s	Forming pin for steel tubes Order code	Forming pins for stainless steel tubes Order code <sup>1) 2)</sup>
06-L/S	MF3EO206	06 × 1 06 × 1.5 06 × 2	BF3EO206X1S BF3EO206X1.5S BF3EO206X2S	BF3EO206X1SS BF3EO206X1.5SS
08-L/S	MF3EO208	08 × 1 08 × 1.5 08 × 2 08 × 2.5	BF3EO208X1S BF3EO208X1.5S BF3EO208X2S BF3EO208X2.5S	BF3EO208X1SS BF3EO208X1.5SS
10-L	MF3EO210	10 × 1 10 × 1.5 10 × 2	BF3EO210LX1S BF3EO210LX1.5S BF3EO210LX2S	BF3EO210LX1SS BF3EO210LX1.5SS BF3EO210LX2SS
10-S	MF3EO210	10 × 1.5 10 × 2 10 × 3	BF3EO210SX1.5S BF3EO210SX2S BF3EO210SX3S	BF3EO210SX1.5SS BF3EO210SX2SS BF3EO210SX3SS
12-L	MF3EO212	12 × 1.5 12 × 2	BF3EO212LX1.5S BF3EO212LX2S	BF3EO212LX1.5SS BF3EO212LX2SS
12-S	MF3EO212	12 × 1.5 12 × 2 12 × 3	BF3EO212SX1.5S BF3EO212SX2S BF3EO212SX3S	BF3EO212SX1.5SS BF3EO212SX2SS BF3EO212SX3SS
15-L	MF3EO215	15 × 1 15 × 1.5 15 × 2	BF3EO215X1S BF3EO215X1.5S BF3EO215X2S	BF3EO215X1.5SS BF3EO215X2SS
16-S	MF3EO216	16 × 2 16 × 2.5 16 × 3	BF3EO216X2S BF3EO216X2.5S BF3EO216X3S	BF3EO216X2SS BF3EO216X2.5SS BF3EO216X3SS
18-L	MF3EO218	18 × 1.5 18 × 2	BF3EO218X1.5S BF3EO218X2S	BF3EO218X1.5SS BF3EO218X2SS
20-S	MF3EO220	20 × 2 20 × 2.5 20 × 3 20 × 3.5	BF3EO220X2S BF3EO220X2.5S BF3EO220X3S BF3EO220X3.5S	BF3EO220X2SS BF3EO220X2.5SS BF3EO220X3SS
22-L	MF3EO222	22 × 1.5 22 × 2	BF3EO222X1.5S BF3EO222X2S	BF3EO222X1.5SS BF3EO222X2SS
25-S	MF3EO225	25 × 2 25 × 2.5 25 × 3 25 × 4	BF3EO225X2S BF3EO225X2.5S BF3EO225X3S BF3EO225X4S	BF3EO225X2SS BF3EO225X2.5SS BF3EO225X3SS
28-L	MF3EO228	28 × 2	BF3EO228X2S	BF3EO228X2SS
30-S	MF3EO230	30 × 3 30 × 4 30 × 5	BF3EO230X3S BF3EO230X4S BF3EO230X5S	BF3EO230X3SS BF3EO230X4SS
35-L	MF3EO235	35 × 2 35 × 3	BF3EO235X2S BF3EO235X3S	BF3EO235X2SS BF3EO235X3SS
38-S	MF3EO238	38 × 3 38 × 4 38 × 5 38 × 6/7	BF3EO238X3S BF3EO238X4S BF3EO238X5S BF3EO238X6+7S	BF3EO238X3SS BF3EO238X4SS BF3EO238X5SS
42-L	MF3EO242	42 × 2 42 × 3	BF3EO242X2S BF3EO242X3S	BF3EO242X2SS BF3EO242X3SS

Please select clamping die and forming pin according to tube dimension and material.

1) All forming pins for stainless steel tubing are marked with a blue dot on front surface.

2) Stainless steel tools are TiN coated.

Clamping die sets which are only used for stainless steel tubes should be marked with the blue dot sticker to avoid use with steel tube.

### Tool lifetime

Assembly tools are subject of wear and must be regularly (max. 50 assemblies) cleaned and checked (Checking instructions see chapter E). Worn out tools can cause dangerous assembly failures and must be replaced in time. Average tool lifetime is approx. 5000 cycles when properly used. Maximum lifetime can be achieved by following factors:

- Regular cleaning and checking
- Clean and corrosion-protected storage
- Proper de-burring and cleaning of tube end
- Proper tool selection and operation
- Use of specified lubricant



# Manual flaring tools for Triple-Lok® tubes

## Flaring tool selection guide



Manual flaring devices are available for on-site assembly and field repair of Triple-Lok® tube connections.

Manual flaring tools range from simple impact flarers to handpump-operated workshop devices. Flaring result and fitting performance depends strongly on the skill and effort of operator. Hand flaring tools are not recommended for efficient industrial production.

### Features, advantages and benefits of hand flaring tools

- 1. Flexible** – Manual flaring tools are portable and do not need any power supply. Therefore they are ideal for on-site assembly and field repair.
- 2. Special** – Each device has been especially developed to match Parker Triple-Lok® standards. The tube connections will fit properly without rework.

How to select the ideal flaring device for your application:

	Hand flaring tools 1004/210A	Impact flaring tool	EO-KARRYFLARE
			
<b>Assembly method</b> Triple-Lok® O-Lok®	impact flaring not suitable	impact flaring not suitable	conventional flaring not suitable
<b>Tube specification</b> Material	copper, steel	copper, steel, stainless steel	steel, stainless steel
Dimension metric tube	6 to 16 mm (1004)	6 to 38 mm	6 to 38 mm
Dimension inch tube	1/8" to 5/8" (210A)	1/4" to 1 1/2"	1/4" to 1 1/2"
Limitations	see specification	see specification	see specification EO-KARRYFLARE
<b>Tools</b> Clamping dies	one device	vice block	Flaring die M15 ... (same dies used EOMAT)
Flaring pin	integral part of device	pin plus hammer	integral part of device
<b>Operation</b> Flaring	hammer impact	hammer impact	handpump
Process control	manual	manual	pressure according to chart
Tube clamping	manual clamping	manual	automatic clamping
<b>Specifications</b> Design	flaring device for use in vice	Hand tools for use in vice	desktop
Weight	approx. 1.5 kg	–	approx. 29 kg
Dimension (W × L × H)	–	–	750 × 360 × 260 mm
<b>Performance</b> Overall cycle time	approx. 1–3 min	approx. 1–3 min	approx. 30–60 sec.
Economic production quantity:	10 flarings per week	10 flarings per week	max. 50 flarings per day
Quality	dependant on operator	dependant on operator	consistent result
<b>Application</b>	on-site repair jobs only; Limited to small dimensions. Limited to single assemblies, not for industrial production, emergency repairs until industrial flared tube is available for replacement.		Efficient for on-site flaring of small quantities not for mass productio



## Assembly tooling

### Manual flaring tools for Triple-Lok® tubes

These 37° flaring tools are for use with copper, aluminum alloy, and thin wall steel or stainless steel tubes. A vice block is clamped together with the tube end into a vicener. Flaring pin is used with a hammer. Separate tooling sets for each tube size in metric and inch dimensions are available.

These hand tools are suitable for small on-site repair jobs. They are not suitable for thick-wall tubing and industrial production. A rigid vice must be available at the assembly site.

#### Features, advantages and benefits

1. **Light** – Hand flaring tools can be used at any assembly site where a proper workshop is not available
2. **Quick** – Hand flaring tools can be used for temporary repair until a proper spare tube has been made by machine

#### Applications

- Field repair of agricultural and construction vehicles
- Small, local repair workshops
- Mobile repair service

### Combination impact flarer 1004 for small dimension metric tube

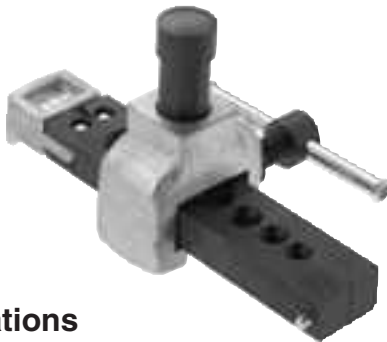

#### Specifications

**Design:** Hand flaring tool for small on-site repair jobs  
**Operation:** Flaring pin Impact  
**37° Flaring:** Triple-Lok® connection – ISO 8434-2/SAE J514  
**Tube material:** copper, aluminum and low carbon steel  
**Tube diameter:** 6 to 16 mm metric tube  
**Wall thickness:** max 15% of tube O.D.  
**Requirements:** Rigid vice and hammer  
**Performance:** Overall cycle time 1–3 min  
**Economic production quantity:** 10 flarings per week

#### Operation

1. Clamp tube end flush in block halves
2. Clean and lubricate tube end and flaring pin
3. Form the flare by a few sharp hammer blows
4. Use pre-flaring pin for tube O.D. 20 mm/3/4" and larger
5. Release vice and unclamp tube

See chapter E for detailed instructions on Triple-Lok® assembly

#### Ordering

Type	Order code
Combination impact flarer Complete device including Combination dies and pin	1004-74M
Tool lubricant 0.1L can	1040LUBCAN

### Combination impact flarer 210A for small dimension inch tube

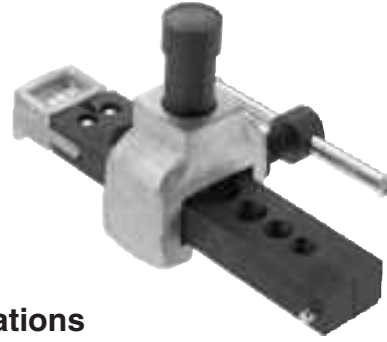

#### Specifications

**Design:** Hand flaring tools for small on-site repair jobs  
**Operation:** Flaring pin Impact  
**37° Flaring:** Triple-Lok® connection – ISO 8434-2/SAE J514  
**Tube material:** copper, aluminum and low carbon steel  
**Tube diameter:** 1/8" to 5/8" inch  
**Wall thickness:** max 15% of tube-O.D.  
**Requirements:** Rigid vice and hammer  
**Performance:** Overall cycle time 1–3 min  
**Economic production quantity:** 10 flarings per week

#### Operation

1. Clamp tube end flush in block halves
2. Clean and lubricate tube end and flaring pin
3. Form the flare by a few sharp hammer blows
4. Release vice and unclamp tube

See chapter E for detailed instructions on Triple-Lok® assembly

#### Ordering

Type	Order code
Combination impact flarer Complete device including Combination dies and pin	210A
Tool lubricant 0.1L can	1040LUBCAN

## Impact flaring tools for metric and inch tube



### Specifications

- Design:** Hand flaring tools for small on-site repair jobs
- Operation:** Impact flaring pin
- 37° Flaring:** Triple-Lok® connection – ISO 8434-2/ SAE J514
- Tube material:** copper, aluminum, steel and stainless steel tube
- Tube diameter:** 6 to 38 mm/1/4" to 1 1/2"
- Wall thickness:** max 15% of tube-O.D., max 10% of tube O.D. for tubes larger 20 mm tube O.D.
- Requirements:** Rigid vice and hammer
- Performance:** Overall cycle time 1–3 min
- Economic production quantity:** 10 flarings per week

### Operation

1. Clamp tube end flush in block halves
2. Clean and lubricate tube end and flaring pin
3. Form the flare by a few sharp hammer blows
4. Use pre-flaring pin for tube O.D. 20 mm/3/4" and larger
5. Release vice and unclamp tube

**See chapter E for detailed instructions on Triple-Lok® assembly**

Tools for metric tube			
Tube-O.D. mm	Pre-flaring pin Order code	Flaring Order code	Vice block Order code
06		P17408	M27406
08		P17408	M05742
10		P17408	M27410
12		P17414	M27412
14		P17414	M27414
15		P17414	M27415
16		P17414	M27416
18		P17418	M27418
20	P1E	P17418	M27420
22	P1E	P17422	M14742
25	P1E	P17422	M27425
30	P1E	P17432	M27430
32	P1E	P17432	M27432
38	P1E	P17438	M24742

Tools for inch tube			
Tube-O.D. inch	Pre-flaring pin Order code	Flaring Order code	Vice block Order code
1/4"		P17408	M04742
5/16"		P17408	M05742
3/8"		P17408	M06742
1/2"		P17414	M08742
5/8"		P17414	M10742
3/4"	P1E	P17418	M12742
7/8"	P1E	P17422	M14742
1"	P1E	P17422	M16742
1.1/4"	P1E	P17432	M20742
1.1/2"	P1E	P17438	M24742

Type	Order code
Tool lubricant 0,1L can	1040LUBCAN



### KarryFlare Portable flaring device for Triple-Lok®



The KarryFlare is a portable device for easy and workmanlike 37° tube flaring. It allows the flaring of even large dimension steel and stainless steel hydraulic tube at assembly sites where Parflange® technology is not available.

The KarryFlare consists of a hydraulic flaring unit and a hand pump. The hydraulic assembly pressure can be read on a gauge which is ergonomically located. The KarryFlare is ideal for tube flaring of

small quantities and on-site tube installation.

It is practical, simple to operate, reliable and easy to transport. The KarryFlare comes as one unit with all components firmly attached to a practical carrying frame.

#### Technical data

37° flaring of hydraulic tube

Flare dimensions and geometry according to ISO 8434 / SAE J514

For Parker Triple-Lok® hydraulic fittings

Tube outer diameter 6 to 38 mm / ¼ to 1 ½"

Maximum capacity: 38 × 4 mm / 1 ½ × 0.120"

With special flaring pin up to 42 mm tube O.D.

Tube material: steel and stainless steel

Weight: approx. 29 kg

Dimensions: approx. L 750 mm × W 360 mm × H 260 mm

Hydraulic oil: H-LP32-1.2I

#### Performance

Cycle time: 30-60 sec.

Economic production quantity: max 50 flarings per day

#### Features, advantages and benefits

1. Flexible on-site tube flaring
2. Simple operation
3. KarryFlare is portable and does not require any power supply
4. Flaring quality is comparable to EOMAT
5. Saves time and effort compared to manual impact flaring
6. Safe and consistent result
7. All elements are ergonomically located
8. Robust, light metal transport box
9. Telescopic handle and wheels for convenient trolley transport
10. Uses "M15" flaring dies (EOMAT/1015)

#### Applications

- Assembly of 37° flare fittings in small quantities
- On-site repair of agricultural vehicles and mobile construction equipment
- Repair workshops and plant maintenance
- Mobile repair service

#### Ordering

KarryFlare device and accessories

Description	Order code
<b>KarryFlare</b> Manual flaring device KarryFlare including handpump, carrying case and manual tank filled with hydraulic oil, 37° flaring pin installed. Flaring dies "M15" must be ordered separately.	KARRYFLARE
<b>Accessoires</b>	
Tool lubricant 0,1 L can	1040LUBCAN
Tool lubricant 1 L refill	LUBSS
Promotion leaflet	LEAF/4049-D1/UK/DE
<b>Spare parts</b>	
Flaring bloc, complete	KARRYFLARE/BLOC
Standard Flaring pin 6–38 mm, with O-ring	KARRYFLARE/FPIN
Special Flaring pin 42 mm, with O-ring	KARRYFLARE/FPIN42
Tube stop with guide	KARRYFLARE/TSTOPKPL
Pressure chart sticker	KARRYFLARE/CHART
Operating manual	OM/4047-T1

KARRYFLARE		
 Tube-O.D. Ø [mm] – Ø [Inch]		 Triple-Lok, P [bar]
6	1/4	35
8	5/16	45
10	3/8	60
12	1/2	60
14		80
15		100
16	5/8	100
18		120
20	3/4	160
22		160
25	1	180
28		215
30	1 1/4	230
35		270
38	1 1/2	280
42		320

37° flaring tools for EO-KARRYFLARE device and EOMAT UNI, II and III machine



Flaring die set M1574



Flaring fixture must be installed on EOMAT UNI II/III

Flaring dies for metric tube	
Tube O.D. mm	Order code
6	M157406-1
8	M157408-1
10	M157410-1
12	M157412
14	M157414
15	M157415
16	M157416
18	M157418
20	M157420
22	M157422
25	M157425
28	M157428
30	M157430
32	M157432
35	M157435
38	M157438
42	M157442

Flaring dies for inch tube	
Tube O.D. inch	Order code
1/4"	M047415-1
5/16"	M157408-1
3/8"	M067415-1
1/2"	M087415
5/8"	M107415
3/4"	M127415
1"	M167415
1.1/4"	M207415
1.1/2"	M157438

Flaring diameters acc. to ISO 8434-2/SAE J514 for Triple-Lok®.

The flaring pin for the EO-KARRYFLARE is integrated in the device. For the EOMAT UNI the flaring pins are in the EOMAT flaring fixture (EOMATBOERDELBX).

Flaring dies are **not** interchangeable with Parflange® tools for 1025/1040/1050-machines.

**Tool lifetime**

Assembly tools are subject of wear and must be regularly (max. 50 assemblies) cleaned and checked (Checking instructions see chapter E). Worn out tools can cause dangerous assembly failures and must be replaced in time. Average tool lifetime is approx. 5000 cycles when properly used. Maximum lifetime can be achieved by following factors:

- Regular cleaning and checking
- Clean and corrosion-protected storage
- Proper de-burring and cleaning of tube end
- Proper tool selection and operation
- Use of specified lubricant



# Assembly machines for O-Lok® and Triple-Lok®

## Parflange® machine selection guide

Parflange® 1025 and Parflange® 1050 are orbital flaring machines designed to cold-form high pressure tube connections. The unique feature of the patented Parflange® process is that the deformation of the tube end is achieved by rolling rather than by just pushing a tool into the tube end. The Parflange® machine smoothly compresses the tube material and achieves a high strength joint with a polished surface of the tube end. O-Lok® sleeves are firmly fixed onto the tube end, resulting in a very rigid high-pressure tube connection.



### Features, advantages and benefits

- 1. Superior sealing performance** – The patented Parflange® process achieves a sealing surface of unique surface quality and mechanical strength.
- 2. Superior vibration resistance** – Unlike conventional flaring, the Parflange® process results in a rigid connection of the O-Lok® sleeve on the tube-end. Parflange®/O-Lok® connections perform much better under reversed bending stress conditions.
- 3. Easy to use** – No programming or adjustments necessary. High quality results are consistently achieved without manual adjustments.
- 4. Cost saving** – Compared to brazing or welding, orbital flaring is much less time consuming. Special tube preparation and finishing are not neces-

sary. Flanging uses only a fraction of the energy needed for brazing or welding.

- 5. Clean** – The Parflange® process is environmental clean and safe. As no heat or chemicals are used, hazards from fumes or heat do not occur.
- 6. Zinc plated tubing.** The Parflange® process allows the use of zinc-plated tubing. The cost for cleaning, post process plating or painting is saved.
- 7. Process/Product concept** – Parflange® machines are especially designed to match Parker O-Lok® and Triple-Lok® standards. Machine, tools and products are fine-tuned for reliable performance.
- 8. Proven technology** – For more than 10 years, hundreds of Parflange® machines have operated worldwide under heavy duty workshop conditions.

How to select the ideal Parflange® Machine for your application:

Machine selection chart	Parflange® 1025		Parflange® 1050	
				
<b>Assembly method</b> Triple-Lok® O-Lok®	Orbital flaring 37° Orbital flanging 180°		Orbital flaring 37° Orbital flanging 180°	
<b>Tube specification</b> Material Dimension metric tube Dimension inch tube	Steel, Stainless Steel 6 × 1 to 25 × 4 mm/42 × 3 mm 1/4" × 0.028" to 1" × 0.120"		Steel, Stainless Steel 6 × 1 to 38 × 5 mm/50 × 3 mm 1/4 × 0.028 to 1 1/2" × 0.188"	
<b>Tools</b> Clamping dies Flaring/flanging pin	special Parflange® tools M40 ... (old: M30 ...) B30 ...		special Parflange® tools M40 ... B30 ...	
<b>Operation</b> Setting Standard sleeve feeding Optional sleeve feeding Tube clamping Flanging/Flaring Process control	automatic adjustment manual loading not available manual clamping automatic drive semi automatic		automatic adjustment manual loading O-Lok® sleeve feeder hydraulic clamping automatic drive fully automatic	
			<b>BASIC</b>	<b>PRO</b>
<b>Specifications</b> Design Weight Dimension (W × L × H)	desktop approx. 85 kg 390 × 670 × 460 mm		stand-alone approx. 380 kg 700 × 840 × 1035 mm	stand-alone approx. 410 kg 700 × 840 × 2030 mm
<b>Performance</b> Version Voltage Overall cycle time Economic production quantity	1.5 kW 400 V 3 Phase approx. 50 secs. max. 100 per day	1.1 kW 230 V 1 Phase approx. 60 secs. max. 50 per day	4.5 kW 400 V 3 Phase approx. 15 secs. max. 500 per day	4.5 kW 400 V 3 Phase approx. 15 secs. max. 1200 per day
<b>Application</b>	Ideal for projects and workshop use and maintenance High quality result No mass production	on-site repair jobs where 3phase power supply is not available	Efficient production machine for low-cost and high-quality assembly	Efficient mass production machine for low-cost and high-quality assembly

**Parflange® 1025 workshop machine for O-Lok® and Triple-Lok®**



The Parflange® 1025 machine is designed to cold-form high pressure tube connections for O-Lok® and Triple-Lok® connection. It uses the patented Parflange® orbital flaring process. The Parflange® 1025 machine smoothly compresses the tube material and achieves a high strength joint with a polished surface of the tube end. O-Lok® and SAE flange sleeves are firmly fixed onto the tube end, resulting in a very rigid high-pressure tube connection.

The 1025 is the smallest machine of the Parflange® machine programme. It is recommended for low-volume assembly jobs of small to medium tube dimensions. Maximum tube capacity is 25 x 4 mm/1" (steel tube) and 25 x 2.5 mm/1" stainless steel tube (3 Phase version). Its advantage is the quick and easy change of tooling and the simple operation without manual adjustments or programming. The machine is transportable so that it can be moved to any assembly site with electrical power supply.

The Parflange® 1025 comes ready to be used. Parflange® tools are purchased separately. For each tube dimension, special clamping dies and Parflange® pins are required.

**Specifications**

Purpose: 180° flanging for O-Lok® and 37° flaring for Triple-Lok®  
 Process: Orbital flaring and flanging according to Parflange® process

Design: Desktop machine for workshop use  
 Tube material: steel and stainless steel tube  
 Tube diameter: metric: 6 to 25 mm Inch: ¼ to 1"  
 Maximum capacity: Steel tube 25 x 4/1" x 0.120 (tube O.D. x wall thickness)  
 Stainless steel tube 25 x 2.5/1" x 0.095  
 Tube specification: fully annealed seamless cold drawn or welded precision tube  
 Performance:  
 Overall cycle time 1.5 kW: 50 sec; 1.1 kW: 60 sec  
 Economic production quantity 1.5 kW: max. 100; 1.1 kW: max. 50  
 Operation: Manual clamping, automatic flanging/flaring  
 Cycle time: approx. 15 to 20 secs.  
 Tools: Flaring pin B30 ... and clamping dies M40 ...  
 Tool clamping: Manual, by eccentric lever  
 Tool lubrication: Automatic lubrication device  
 Lubricant: LUBSS (filled when delivered)  
 Hydraulic oil: HLP 23 0.5L (filled when delivered)  
 Installation: rigid workbench and electrical power supply required  
 Dimensions: 390 x 670 x 460 mm  
 Weight: 85 kg

### Features, advantages and benefits

- 1. Superior sealing performance** – The patented Parflange® process achieves a sealing surface of unique surface quality and mechanical strength.
- 2. Superior vibration resistance** – Unlike conventional flaring, the Parflange® process results in a rigid connection of the O-Lok® sleeve on the tube-end. Parflange®/O-Lok® connections perform much better under reversed bending stress conditions.
- 3. Easy to use** – No programming or adjustments necessary. High quality results are consistently achieved without manual adjustments.
- 4. Quality** – Machine setting, tool control and even lubrication are fully automated so that high and consistent quality results are achieved without manual adjustments.
- 5. Small bending radii** – The compact clamping device and special dies are suitable for flanging short tube ends.
- 6. Cost saving** – Compared to brazing or welding, orbital flanging is much less time consuming. Special tube preparation and finishing are not necessary. Flanging uses only a fraction of the energy needed for brazing or welding.
- 7. Clean** – The Parflange® process is environmental clean and safe. As no heat or chemicals are used, hazards from fumes or heat do not occur.
- 8. Zinc plated tubing** – The Parflange® process allows the use of zinc-plated tubing. The cost for cleaning or painting can be saved.
- 9. High tool lifetime** – The Parflange® 1025 machine is equipped with an automatic lubrication device. The tools will not wear rapidly if the operator does not lubricate regularly.
- 10. Process/Product concept** – Parflange® machines are especially designed to match Parker O-Lok® and Triple-Lok® standards. Machine, tools and products are fine-tuned for reliable performance.
- 11. Proven technology** – Since more than 10 years, hundreds of Parflange® machines have operated worldwide under heavy duty workshop conditions.

### Applications

Workshop use, project work, plant maintenance, on-site assembly.

Not for efficient mass production

### Ordering

Type	Order code
Parflange® 1025 Basic machine Ready to use, Including operating manual, Filled with hydraulic oil and lubricant Without Parflange® tools	
Basic machine 400 V, 3 Phase, 50 Hz	1025-380VTRI50
Basic machine 230 V, 1 Phase, 50 Hz	1025-220VMONO50
1025 promotion leaflet UK	4390/UK
1025 promotion leaflet DE	4390/DE
1025 operating manual UK/DE/FR/IT	1025/MANUAL

Parflange® machines are shipped in a special container which should be kept for all transports to avoid damage.

### Spare parts

Type	Order code
Tool lubricant qty: 1L	LUBSS
Drive belt	1025/028POLYV
Came guide and with screw	1025/0281031
Hydraulic tank seal kit	1025/0281042
Lubrication kit	1025/0281200



## Parflange® 1050 WorkCenter



Bins can be stored on top platforms



Easy refill of tool lubricant

The new Parflange® 1050 WorkCenter is the top-of-the-range machine for orbital flaring & flanging of O-Lok® and Triple-Lok® tube assemblies. It combines the practical EO2-FORM F3 WorkCenter concept with the proven Parflange® technology.

Due to the robust design and the precise process control, the new Parflange® 1050 WorkCenter achieves consistent high quality results and high productivity. Machine housing, cycle programming and all operating elements are designed for good ergonomics, optimum workflow and highest security. The compact Parflange unit and the compact housing allow the forming of small and complex tube bends. Maximum tool lifetime is achieved by the automatic lubrication system as well as easy visibility and accessibility of the tooling area. The integrated tool compartments and designated space for bins for nuts and sleeves make it comfortable and efficient to work with the Parflange® 1050.

### Parflange® advantages over brazing or welding

**Faster and lower cost** – 9 to 12 times the speed of comparable induction brazing.

**Flexibility** – Small batch quantities are practical due to short tool change times.

**Simple tube preparation** – The Parflange® process does not require any special pre- or post-flange cleaning of the tube and sleeve.

**Safety** – Unlike brazing, the Parflange® process does not require any flux, braze alloy, post braze cleaner or rust inhibitor. An environmentally safe lubricant applied to the flanging pin is the only additive associated with the Parflange®.

**Environment** – The Parflange® process is environmentally clean and safe. It does not require open flame or any form of heating. Additionally, there is no emission of hazardous fumes, as is typical with welding and brazing.

**Energy** – The Parflange® process uses only a fraction of the energy needed for welding or brazing.

**Corrosion resistance** – The Parflange® process accommodates the use of plated or unplated components (i.e. tube and sleeve). Thus, the high costs of electro-plating assemblies after fabrication is eliminated by using pre-plated tube.

**Excellent surface quality** – The Parflange® process eliminates the potential leak path present at the braze or weld joint.

### Features and benefits

- Cost saving** – Compared to welding or brazing, orbital flanging is much less time consuming. Special tube preparation and finishing are not necessary. Flanging uses only a fraction of the energy needed for brazing or welding.
- Zinc plated tubing** – The Parflange® process allows the use of zinc-plated tubing. The cost for cleaning post process plating, or painting can be saved.
- High tool lifetime** – The Parflange® 1050 machine is equipped with an automatic lubrication device. The operator does not have to lubricate the tools ensure long pin life.
- Use of existing tools** – All existing Parflange® tools (M40 dies and B30/B40 pins) fit into the new machine generation.

- WorkCenter concept** – When the doors are opened, the machine body turns into a WorkCenter for production of O-Lok® and Triple-Lok® tube assemblies. All tools are available for rapid and convenient machine setup and tool change.

- Low-cost mass production** – The machine can be ordered with an automated sleeve feeder. The Parflange® 1050 then is the perfect solution for low-cost mass production.

- Universal** – The Parflange® 1050 can do 37° flaring for Triple-Lok® connectors and flange tubes for O-Lok® fittings (ORFS). Parflange® tools cover metric tube from 6 to 50 mm O.D. and inch tube from 1/4 to 2" O.D.

- Flange Seal** – The Parflange® 1050 is also capable for the innovative Flange Seal connection, which contributes to reduce component cost and assembly time.

- Heavy duty** – The rigid machine design allows use for mass production of even large stainless steel tube connections.

- Process/Product concept** – Parflange® machines are especially designed to match O-Lok®, Triple-Lok® and SAE-flange standards. Machine, tools and products are fine-tuned for reliable performance.

- Superior sealing performance** – The patented Parflange® process achieves a sealing surface of unique surface quality and mechanical strength.

- Superior vibration resistance** – Unlike conventional flaring, the Parflange® process results in a rigid connection of the O-Lok® sleeve on the tube-end. Parflange®/O-Lok® connections perform much better under reversed bending stress conditions.

- Efficient** – The short cycle time and the automatic process allow efficient mass production.

- Quality** – Tube clamping, tool control and even lubrication is fully automated so that high and consistent quality results are achieved without manual adjustments.

- Easy to use** – The clamping and flanging process is fully automated. Manual tool manipulation is not required. The process is initiated by pushing the tube end into the tooling.

- Bin holder** – The top surface is designed to store two standard bins for fitting nuts and Parflange® sleeves. Everything is easy to reach for the operator.

- Illuminated tooling area** – Insertion of Parflange® sleeves and condition monitoring of tools is easy.

- Practical lubricant refill** – The container for tool lubricant is easily accessible by a hatch on the machine side.

- Side drawer** – Chips, dirt and dropped components like Parflange® sleeves can be removed by a small drawer. This allows to keep the working area clear and avoid jamming of moving parts.

- Clean** – The Parflange® process is environmentally clean and safe. As no heat or chemicals are used, hazards from fumes or heat do not occur.

- Perfect for project work** – After finishing a piping project, the machine can be put aside. Tools don't get lost and dirty. For the next project, the machine just needs to be transported to the new site and unfolded into the WorkCenter. This is particularly useful for piping projects in shipyards, paper mills, offshore platforms or steel mills.

- Ready to go** – The Parflange® WorkCenter is delivered including all necessary details like electrical plug, operator manual, short instruction pictograms on machine housing and dimensional charts for tube preparation.

- New Generation** – The Parflange® 1050 WorkCenter replaces the Parflange® 1040 machine, which has been successful in the market for more than 12 years.

### Parflange® 1050 BASIC

#### Technical description 1050 BASIC:

The Parflange® 1050 is a production WorkCenter for orbital flaring and flanging of high pressure tube connections. The unique feature of the patented Parflange® process is that the deformation of the tube end is achieved by rolling rather than by just pushing a tool into the tube end.

The Parflange® machine smoothly compresses the tube material and achieves a high strength joint with a polished surface of the tube end.

O-Lok® and SAE flange sleeves are firmly fixed onto the tube end, resulting in a very rigid high-pressure tube connection.

The Parflange® 1050 is the heavy-duty, mass production WorkCenter of the Parflange® machine programme.

It is recommended for industrial production of all sizes Triple-Lok® and O-Lok® tube connections.

Maximum tube capacity is 50 mm/2" tube O.D.

The powerful drive and the fast, automatic process allow short cycle times for efficient production. Its advantage is the quick and easy change of tooling and the simple operation without manual adjustments or programming. Tube clamping and tool lubrication are done automatically.

The Parflange® 1050 comes ready to be used. Parflange® tools have to be purchased separately. For each tube dimension, special clamping dies and Parflange® pins are required. The machine can be moved on wheels, by forklift truck and crane. For basic use, just an electrical power supply is required.



#### Machine specification 1050 BASIC:

Purpose:	180° Flanging for O-Lok® and 37° Flaring for Triple-Lok®	Speed:	5–8 sec. flanging time/15–20 sec. total cycle time
Process:	Orbital flaring and flanging according to Parflange® process	Economic production quantity:	max. 500 flarings per day
Design:	WorkCenter for industrial production	Tools:	Flaring pin B30 ... or B40 ... Clamping dies M40 ...
Tube material:	Steel and stainless steel tube	Tool compartments:	10 die sets, 10 pins
Tube diameter:	Metric: 6 to 50 mm Inch: 1/4" to 2"	Tool clamping:	Automatic
Maximum capacity:	Steel tube (ST 37, ST 52, ...) Metric: 38 × 5/50 × 3 mm (tube O.D. × wall thickness) Inch: 1 1/2" × 0.188 Stainless steel tube (1.4571, 316, ...) Metric: 38 × 4 mm Inch: 1 1/2" × 0.156	Tool lubrication:	Automatic lubrication device
Tube specification:	Fully annealed seamless cold drawn or welded and redrawn precision tube	Lubricant:	LUBSS (filled when delivered)
Operation:	Automatic clamping, automatic flanging/flaring	Hydraulic oil:	HLP 46 (filled when delivered)
		Installation:	Electrical power
		Dimensions:	700 × 840 × 1035 mm
		Platform for bins:	2 platforms, 300 × 500 mm, max. 5 kg each
		Weight:	380 kg
		Electrical power:	400 V, 3 Phase, 50 Hz, 4.5 kW
		Transport options:	On wheels, by forklift truck, lifting attachments

## Parflange® 1050 PRO

### Technical description 1050 Pro:

For industrial mass production of O-Lok® connections, special machines Parflange® 1050 PRO with O-Lok® sleeve feeder are available. This sleeve feeding device increases the productivity, particularly of high volume – single tube dimension jobs.

In “Feeder ON – mode”, O-Lok® sleeves just need to be inserted into feeder rails. First cycle start is initiated by manually closing the safety cover. Then, all following cycles are started by pushing the tube into the pre-clamped dies. All other machine activities, like tube clamping, flanging, tube release, insertion of O-Lok® sleeves into dies, pre-clamping of dies and the operation of safety cover run fully automatic. The operator just is handling the tubes and refilling the sleeve-feeder from times to times with O-Lok® sleeves.

In “Feeder OFF – mode”, the Parflange® 1050 PRO operates like the Parflange® 1050 BASIC without O-Lok® sleeve feeder. This mode is useful for maximum size flexibility and Triple-Lok® assembly. For quick changeover and safety reasons, the O-Lok® sleeve feeder is just switched OFF but not be removed from the Parflange® 1050 PRO WorkCenter.

For operation of O-Lok® PRO machines, compressed air supply is required, even when sleeve feeder is not used.



### Machine specification 1050 PRO:

#### Specific differences of Parflange® 1050 Pro versus Parflange® 1050 Basic

Design:	Parflange® 1050 with additional O-Lok® sleeve feeder	Feeder:	Feeder is delivered in separate box and must be firmly attached to machine. Feeder can be switched ON and OFF but must not be removed.
Normal Operation:	Same as Parflange® 1050 Basic when feeder is switched off	Feeder rails:	Feeder rail kits must be ordered separately for each O-Lok® sleeve size.
Feeder Operation:	Work-cycle is initiated by inserting tube end Automatic clamping, automatic flanging/flaring Automatic insertion of O-Lok® sleeves into dies Automatic operation of safety cover Automatic pre-clamping of dies	Feeder setup:	Installation of matching rail kit by knurled nuts and adjustment of scale wheel according to chart
Cycle time:	5–8 sec. flanging time/approx. 15 to 20 sec. total cycle time	Installation:	Electrical power, for feeder type machines: compressed air supply (6 bar)
Economic production quantity:	max. 1200 flarings per day	Dimensions:	700 × 840 × 2030 mm
Tools:	Same tools as Parflange® 1050 BASIC	Weight:	410 kg

## Assembly tooling

### Parflange® 1050 Ordering

Type	Order code
Parflange® 1050 Basic machine Ready to use, including operation manual, filled with hydraulic oil and lubricant Without Parflange® tools Basis machine Europe version (not prepared for O-Lok® sleeve feeder)	
Purchase	1050EU400VBASIC
Leasing (2 year hire purchase)	1050BASICLEASEFEE
Rent (monthly)	1050BASICRENTFEE



Parflange®  
1050 BASIC

Type	Order code
Parflange® 1050 PRO machine Europe version including O-Lok® sleeve feeder without feeder rails	
Purchase	1050EU400VPRO
Leasing (2 year hire purchase)	1050PROLEASEFEE
Rent (monthly)	not available

Parflange®  
1050 PRO for  
mass production  
of O-Lok®  
assemblies



Sleeve feeder rails for Parflange® 1050 PRO	Tube O.D.	Order code
O-Lok® sleeve feeding rail	6 mm/1/4"	1050/RAIL04
O-Lok® sleeve feeding rail	8, 10 mm/3/8"	1050/RAIL06
O-Lok® sleeve feeding rail	12 mm/1/2"	1050/RAIL08
O-Lok® sleeve feeding rail	14, 15, 16 mm/5/8"	1050/RAIL10
O-Lok® sleeve feeding rail	18, 20 mm/3/4"	1050/RAIL12
O-Lok® sleeve feeding rail	22, 25 mm/1"	1050/RAIL16
O-Lok® sleeve feeding rail	28, 30, 32 mm/1 1/4"	1050/RAIL20
O-Lok® sleeve feeding rail	35, 38 mm/1 1/2"	1050/RAIL24



Feeder rail kits are  
available for each  
O-Lok® size

1050 promotion leaflet	4391-1 via Parker catalogue service EMDC
1050 operating manual UK/DE/FR/IT/ES	1050/MANUAL

Tool lubricant refill qty: 1L	LUBSS
Replacement cartridge for spindle lubrication	1050/22900001801



High-Performance lubricant  
for Parflange®

Parflange® machines and feeders are shipped in special containers which should be kept for future transports to avoid damage. Please don't dispose the transport boxes!!!

## Tooling for Parflange® machines

### Machine and tool selection



Parflange® 1025



Parflange® 1050

#### Parflange® 1025 machines flanging capacity for O-Lok®

Tube material	220 V 1,1 kW	380 V 1,5 kW
	Max. tube size mm (inch)	
Steel ST37	25 × 4 (1" × 0.120)	25 × 4 (1" × 0.120)
Stainless steel 304L/316L*	25 × 4 (1" × 0.120)	25 × 4 (1" × 0.120)
Steel ST52	25 × 4 (1" × 0.120)	25 × 4 (1" × 0.120)

#### Parflange® 1050 machines flanging capacity for O-Lok®

Tube material	Max tube size mm (inch)
Steel ST37	38 × 5/50 × 3 (2 × .120)
Steel ST52	38 × 4 (1½ × .156)
Stainless steel 304L/316L*	38 × 4 (1½ × .156)

#### Parflange® 1025 machines flaring capacity for Triple-Lok®

Tube material	Elect. power of machine	
	220 V 1.1 kW	380 V 1.5 kW
Max. tube size mm (inch)		
Steel ST37	25 × 3 (1" × 0.120)	25 × 3 (1" × 0.120)
Stainless steel 304L/316L* Steel TU 52 B	25 × 3 (1" × 0.120)	25 × 3 (1" × 0.120)
Stainless steel Duplex (or PW 400)	Not recommended	25 × 2.5 (1 × .095)

#### Parflange® 1050 machines flaring capacity for Triple-Lok®

Tube material	Elect. power of machine
	220/380 V 4,5 kW
Max. tube size mm (inch)	
Steel TU 37 B	38 × 4/42 × 3 (1½ × .120)
Steel TU 52 B	38 × 4/42 × 3 (1½ × .120)
Stainless steel 304L/316L*	38 × 4/42 × 3 (1½ × .120)
Stainless steel Duplex (or PW 400)	38 × 3.6

\* Parflange® tools for stainless steel tubes have different dimensions and are specially coated. These tools are marked with suffix "SS".

**Parflange® tool identification**



Parflange® tools for O-Lok®

Parflange® tools for Triple-Lok®

**Tooling for metric tubing**

Metric die numbering system

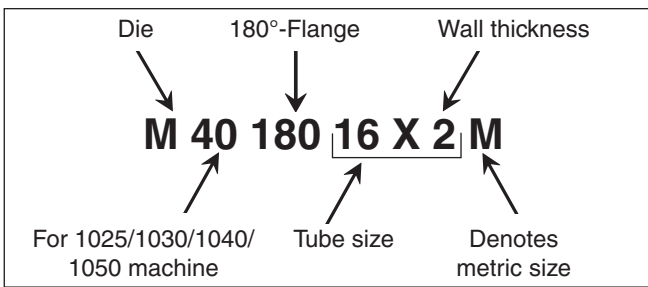

Metric pin numbering system

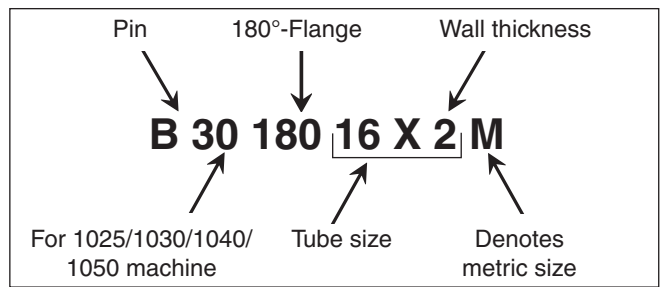

**Tooling for inch tubing**

Die numbering system

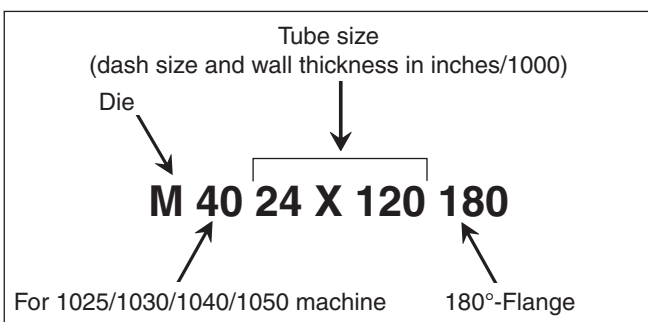

Pin numbering system

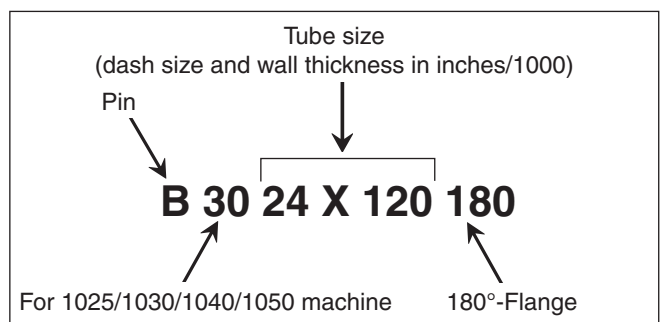

Parflange® tools for stainless steel tubes have different dimensions and are specially coated. These tools are marked with suffix "SS".

**Tool lifetime**

Assembly tools are subject of wear and must be regularly (max. 50 assemblies) cleaned and checked (Checking instructions see chapter E). Worn out tools can cause dangerous assembly failures and must be replaced in time. Average tool lifetime is approx. 5000 cycles when properly used. Maximum lifetime can be achieved by following factors:

- Regular cleaning and checking
- Clean and corrosion-protected storage
- Proper de-burring and cleaning of tube end
- Proper tool selection and operation
- Use of specified lubricant

## Parflange® tools for O-Lok®

Parflange® tooling – Order codes for Parflange® 1050/1040/1030/1025

### 90°-Flange-tool-selection (Metric tube)

Tube size mm	Steel tube		Stainless steel tube	
	Flange pin Order code	Flange die Order code	Flange pin Order code	Flange die Order code
6 × 1	B3018006X1M	M4018006X1M		
6 × 1.5	B3018006X1.5M	M4018006X1.5M		
8 × 1	B3018008X1M	M4018008X1M	B3018008X1MSS	M4018008X1MSS
8 × 1.5	B3018008X1.5M	M4018008X1.5M	B3018008X1.5MSS	M4018008X1.5MSS
10 × 1	B3018010X1M	M4018010X1M	B3018010X1MSS	M4018010X1MSS
10 × 1.5	B3018010X1.5M	M4018010X1.5M	B3018010X1.5MSS	M4018010X1.5MSS
10 × 2	B3018010X2M	M4018010X2M		
12 × 1	B3018012X1M	M4018012X1M	B3018012X1MSS	M4018012X1MSS
12 × 1.5	B3018012X1.5M	M4018012X1.5M	B3018012X1.5MSS	M4018012X1.5MSS
12 × 2	B3018012X2M	M4018012X2M		
15 × 1			B3018015X1MSS	M4018015X1MSS
15 × 1.5	B3018015X1.5M	M4018015X1.5M		
15 × 2	B3018015X2M	M4018015X2M		
16 × 1.5	B3018016X1.5M	M4018016X1.5M	B3018016X1.5MSS	M4018016X1.5MSS
16 × 2	B3018016X2M	M4018016X2M	B3018016X2MSS	M4018016X2MSS
16 × 2.5	B3018016X2.5M	M4018016X2.5M		
18 × 1.5	B3018018X1.5M	M4018018X1.5M		
18 × 2	B3018018X2M	M4018018X2M		
20 × 2	B3018020X2M	M4018020X2M	B3018020X2MSS	M4018020X2MSS
20 × 2.5	B3018020X2.5M	M4018020X2.5M		
20 × 3	B3018020X3M	M4018020X3M		
22 × 2	B3018022X2M	M4018022X2M		
22 × 2.5	B3018022X2.5M	M4018022X2.5M		
25 × 2.5	B3018025X2.5M	M4018025X2.5M	B3018025X2.5MSS	M4018025X2.5MSS
25 × 3	B3018025X3M	M4018025X3M		
28 × 2	B3018028X2M	M4018028X2M		
28 × 2.5	B3018028X2.5M	M4018028X2.5M		
30 × 2	B3018030X2M	M4018030X2M		
30 × 3	B3018030X3M	M4018030X3M	B3018030X3MSS	M4018030X3MSS
30 × 4	B3018030X4M	M4018030X4M		
32 × 3	B3018032X3M	M4018032X3M		
32 × 4	B3018032X4M	M4018032X4M		
35 × 3	B3018035X3M	M4018035X3M		
38 × 3	B3018038X3M	M4018038X3M		
38 × 4	B3018038X4M	M4018038X4M		

### 90°-Flange-tool-selection (Inch tube)

Tube size inch	Steel tube	
	Flange pin Order code	Flange die Order code
1/4 × 0.035	B3004X035180	M4004X035180
1/4 × 0.049	B3004X049180	M4004X049180
3/8 × 0.035	B3006X035180	M4006X035180
3/8 × 0.049	B3006X049180	M4006X049180
3/8 × 0.065	B3006X065180	M4006X065180
1/2 × 0.035	B3008X035180	M4008X035180
1/2 × 0.049	B3008X049180	M4008X049180
1/2 × 0.065	B3008X065180	M4008X065180
5/8 × 0.065	B3010X065180	M4010X065180
5/8 × 0.083	B3010X083180	M4010X083180
3/4 × 0.065	B3012X065180	M4012X065180
3/4 × 0.083	B3012X083180	M4012X083180
3/4 × 0.095	B3012X095180	M4012X095180
3/4 × 0.120	B3012X120180	M4012X120180
1 × 0.065	B3016X065180	M4016X065180
1 × 0.095	B3016X095180	M4016X095180
1 1/4 × 0.120	B3020X120180	M4020X120180

Further tools for Inch tubing are available from Parker TFD Columbus!



#### Tool lifetime

Assembly tools are subject of wear and must be regularly (max. 50 assemblies) cleaned and checked (Checking instructions see chapter E). Worn out tools can cause dangerous assembly failures and must be replaced in time. Average tool lifetime is approx. 5000 cycles when properly used. Maximum lifetime can be achieved by following factors:

- Regular cleaning and checking
- Clean and corrosion-protected storage
- Proper de-burring and cleaning of tube end
- Proper tool selection and operation
- Use of specified lubricant

## Assembly tooling

### Parflange® tools for Triple-Lok®

#### Metric tube

Tube size mm	Steel tube		Stainless steel tube	
	Flare pin Order code	Flare die Order code	Flare pin Order code	Flare die Order code
6 × 1 6 × 1.5	B3007406X1M B3007406X1.5M	M4007406M M4007406M	B3007406X1MSS	M4007406M
8 × 1 8 × 1.5	B3007408X1M B3007408X1.5M	M4007408M M4007408M	B3007408X1MSS B3007408X1.5MSS	M4007408M M4007408M
10 × 1 10 × 1.5	B3007410X1M B3007410X1.5M	M4007410M M4007410M	B3007410X1MSS B3007410X1.5MSS	M4007410M M4007410M
12 × 1 12 × 1.5 12 × 2	B3007412X1M B3007412X1.5M B3007412X2M	M4007412M M4007412M M4007412M	B3007412X1.5MSS	M4007412M
15 × 1.5 15 × 2	B3007415X1.5M B3007415X2M	M4007415M M4007415M	B3007415X1.5MSS	M4007415M
16 × 1.5 16 × 2	B3007416X1.5M B3007416X2M	M4007416M M4007416M	B3007416X2MSS	M4007416M
18 × 1.5 18 × 2	B3007418X1.5M B3007418X2M	M4007418M M4007418M	B3007418X1.5MSS	M4007418M
20 × 2 20 × 2.5	B3007420X2M B3007420X2.5M	M4007420M M4007420M	B3007420X2MSS B3007420X2.5MSS	M4007420M M4007420M
22 × 1.5 22 × 2 22 × 2.5	B3007422X1.5M B3007422X2M B3007422X2.5M	M4007422M M4007422M M4007422M	B3007422X1.5MSS	M4007420M
25 × 2 25 × 3	B3007425X2M B3007425X3M	M4007425M M4007425M	B3007425X2.5MSS	M4007425M
28 × 2 28 × 2.5	B3007428X2M B3007428X2.5M	M4007428M M4007428M		
30 × 3	B3007430X3M	M4007430M	B3007430X3MSS	M4007430M
32 × 3	B3007432X3M	M4007432M		
35 × 3	B3007435X3M	M4007435M		
38 × 3 38 × 4	B3007438X3M B3007438X4M	M4007438M M4007438M	B3007438X4MSS	M4007438M
42 × 3 42 × 4	B3007442X3M B3007442X4M	M4007442M M4007442M		

#### Inch tube

Tube size inch	Steel tube	
	Flange pin Order code	Flange die Order code
1/4 × 0.049	B3004X049074	M4004074
3/8 × 0.049 3/8 × 0.065	B3006X049074 B3006X065074	M4006074 M4006074
1/2 × 0.065	B3008X065074	M4008074
5/8 × 0.065 5/8 × 0.095	B3010X065074 B3010X095074	M4010074 M4010074
3/4 × 0.095	B3012X095074	M4012074
1 × 0.109	B3016X109074	M4016074
1 1/4 × 0.120	B3020X120074	M4020074

Further tools for Inch tubing are available from Parker TFD Columbus!

#### Tool lifetime

Assembly tools are subject of wear and must be regularly (max. 50 assemblies) cleaned and checked (Checking instructions see chapter E). Worn out tools can cause dangerous assembly failures and must be replaced in time. Average tool lifetime is approx. 5000 cycles when properly used. Maximum lifetime can be achieved by following factors:

- Regular cleaning and checking
- Clean and corrosion-protected storage
- Proper de-burring and cleaning of tube end
- Proper tool selection and operation
- Use of specified lubricant



## Parflange® tools for Flange Seal

Flange dies and Parflange® pins for machines 1050/1040/1030/1025 steel tube



Clamping die set M ... 180

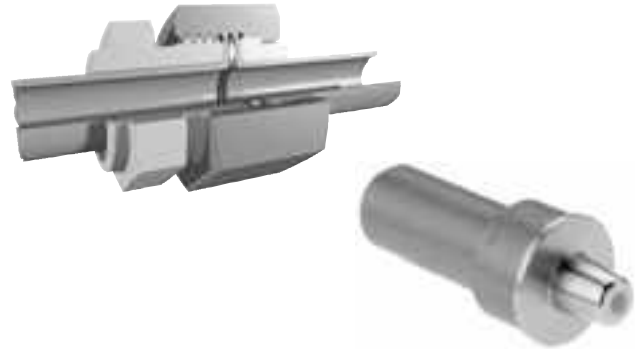

Parflange® pin B ... 180



### Metric tube

Tube size (O.D. × wall thickness) mm	Flange pin Order code	Flange die Order code
6×1	B3018006X1M	M4018006X1MLHP
8×1 8×1.5	B3018008X1M B3018008X1.5M	M4018008X1MLHP M4018008X1.5MLHP
10×1 10×1.5 10×2	B3018010X1M B3018010X1.5M B3018010X2M	M4018010X1MLHP M4018010X1.5MLHP M4018010X2MLHP
12×1 12×1.5	B3018012X1M B3018012X1.5M	M4018012X1MLHP M4018012X1.5MLHP
16×2	B3018016X2M	M4018016X2MLHP
20×2.5	B3018020X2.5M	M4018020X2.5MLHP
25×2.5 25×3	B3018025X2.5M B3018025X3M	M4018025X2.5MLHP M4018025X3MLHP

### Inch tube

Tube size (O.D. × wall thickness) Inch	Flange pin Order code	Flange die Order code
1/4×0.035 1/4×0.049	B4004X035180 B4004X049180	M4004X035180LHP M4004X049180LHP
3/8×0.049 3/8×0.065	B4006X049180 B4006X065180	M4006X049180LHP M4006X065180LHP
1/2×0.049 1/2×0.065 1/2×0.083	B4008X049180 B4008X065180 B400810X083180	M4008X049180LHP M4008X065180LHP M4008X083180LHP
5/8×0.065	B401010X065180	M4010X065180LHP
5/8×0.083	B401010X083180	M4010X083180LHP
3/4×0.065 3/4×0.083	B4012X065180 B4012X083180	M4012X065180LHP M4012X083180LHP
1×0.095	B4016X095180	M4016X095180LHP

### Tool lifetime

Assembly tools are subject of wear and must be regularly (max. 50 assemblies) cleaned and checked (Checking instructions see chapter E). Worn out tools can cause dangerous assembly failures and must be replaced in time. Average tool lifetime is approx. 5000 cycles when properly used. Maximum lifetime can be achieved by following factors:

- Regular cleaning and checking
- Clean and corrosion-protected storage
- Proper de-burring and cleaning of tube end
- Proper tool selection and operation
- Use of specified lubricant

## Lubricants

### NIROMONT lubricant for fitting assembly

### LUBSS/LUBCAN lubricant for flaring and forming tools

**NIROMONT** is a high-performance lubricant which has been especially developed for the assembly of bite-type fittings.

For best individual application, EO-Niromont is available in a small tin (paste) or plastic bottle (liquid).

**LUBSS/LUBCAN** is a special lubricant for flaring dies, Parflange® tools and EO2-FORM tooling. It allows high-quality tube forming without excessive tool wear.

LUBSS is the standard Lubricant for the Parflange® machine automatic tool lubrication system.



NIROMONT

### Features, advantages and benefits of NIROMONT lubricant:

1. **Highly effective** – Niromont dramatically reduces assembly effort. This helps to prevent fitting failure resulting from insufficient assembly.
2. **Cost saving** – Tools in assembly machines will last much longer, resulting in high-quality tube forming with excellent sealing surface.
3. **No cold welding** – Cold welding of stainless steel threads is impossible when EO-Niromont is properly applied.
4. **Liquid** – Penetrates even small gaps.
5. **Paste** – Stays in place for a while. Ideal for application on pre-assembly tools.
6. **Compatible** – NIROMONT and LUBSS/LUBCAN do not effect fitting surfaces or seal materials.



LUBSS



1040LUBCAN

### Ordering

Type	Order code
NIROMONT Assembly lubricant paste (130 g)	EONIROMONTPASTX
NIROMONT Assembly lubricant liquid (250 cc)	EONIROMONTFLUCESSX
Forming tool lubricant can (100 cc)	1040LUBCAN
Forming tool lubricant refill (1 L)	LUBSS

## Cutting and bending tools

### AV 6/42 – Tube saw square

Provides a neat and quick method of cutting tube at right angles. The exact cut is achieved by hardened guides. We recommend using deeper-section sawblades that cut in both directions for best results. The AV 6/42 can be used in a vice or just be clamped onto the tube for cutting.

#### Specifications:

Tube. O.D.: 6–42 mm  
Weight: approx. 0.7 kg

Type	Order code
Tube cutting tool	AV06/42KPLX
Spare hardened guides	AV06/4208X

#### Features, advantages and benefits of tube saw square:

1. **Square cut** – Exact tube preparation greatly reduces leakage caused by assembly failures.
2. **Contour clamping** – Tube is not distorted by clamping.
3. **No vice required** – For workshop application AV 6/42 can simply be clamped onto the tube without using a vice or other attachment.
4. **Replaceable guides** – Worn out guides can easily be replaced to maintain neat cutting result.
5. **Light** – At only 0.7 kg, the AV 6/42 should be carried in the toolbox of every hydraulic tube fitter.



## Cutting and bending tools

### BAV 6/12 – Combined tube bending and cutting tool

The BAV 6/12 is a workshop device for neat tube cutting and simple but exact bending of small dimension EO-tube. Relatively small bending radii can be achieved.

The exact cut is achieved with hardened guides and using sawblades which are notched on both sides. The BAV 6/12 can be used in a vice or just be clamped onto a workbench.

#### Specifications:

Tube. OD: 6–12 mm  
Weight: approx. 2 kg

Type	Order code
Combined tube bending and cutting tool including 3 bending rolls for 6 to 12 mm tube and bending lever	BAV06/12KPLX
<b>Spare Parts</b>	
Spare hardened guide	BAV06/1206X
Bending roll 6/8 mm	BAV06/1209X
Bending roll 10 mm	BAV06/1210X
Bending roll 12 mm	BAV06/1211X
Bending pin	BAV06/1207X
lever complete	BAV06/1220KPLX

Bending dimensions in mm			
Rolls for tube O.D.	6/8	10	12
Bending radius	19/20	25	26



#### Features, advantages and benefits of combined tube bending and cutting tool:

- Bending and cutting** – The BAV 6/12 is a light multi-purpose tool for all small dimension tube assemblies.
- Square cut** – Exact tube preparation greatly reduces leakage caused by assembly failures.
- No vice required** – For workshop application BAV 6/12 can simply be clamped onto a workbench.
- Small bending radii** – Compact tube bends allow tight assemblies.
- Light** – At only 2 kg, the BAV 6/12 can be easily brought to the assembly site.
- Optimised bending roller contour** – Special shape of bending roller allows small bends without tube flattening.

### In-Ex tube deburring tool 226

Material: Aluminum with hardened steel blades  
Tube-O.D.: 4 to 42 mm  
Weight: 0.12 kg

Type	Order code
Tube deburrer	226A
Replacement blades	226A Blades

#### Features, advantages and benefits of In-Ex tube deburring tool 226:

- Proper deburring** – Exact tube preparation greatly reduces leakage caused by assembly failures.
- Replaceable blades** – Worn out blades can easily be replaced to maintain neat deburring result.
- Light** – At only 0.12 kg, the In-Ex tube deburring tool should be carried in the toolbox of every hydraulic tube fitter.



## Cutting and bending tools

### BV 6/18 – Tube bending tool

The BV 6/18 is a flexible bending device for simple but exact bending of EO-tube up to 18 mm tube O.D. The high quality bending results are achieved by 6 interchangeable bending rollers.

The fixing roller can be individually adjusted to produce a precise bend transition.

#### Specifications:

Tube-O.D.: 6–18 mm

Weight: approx. 4 kg



Type	Order code
Tube bending tool complete device including 6 bending rolls for 6 to 18 mm tube and bending lever	BV06/18KPLX
<b>Spare Parts</b>	
Bending roll 6/8 mm	BV06/1812X
Bending roll 10/12 mm	BV06/1803X
Bending roll 14 mm	BV06/1804X
Bending roll 15 mm	BV06/1805X
Bending roll 16 mm	BV06/1806X
Bending roll 18 mm	BV06/1807X
Fixing roll	BV06/1802X
Lever complete	BV06/1808KPLX

Bending dimensions in mm		
Rolls for tube O.D.	r	≈ X
6	33.0	35
8	34.0	35
10	35.5	35
12	36.5	35
14	36.5	35
15	44.0	38
16	44.0	38
18	51.5	42

#### Features, advantages and benefits of tube-bending tool:

1. **Vice mounted** – For easy workshop use, the BV can be clamped into a vice.
2. **Small bending radii** – Compact tube bends allow tight assemblies.
3. **Light** – At only 4 kg, the BV 6/18 can be easily brought to each assembly site.
4. **Optimised bending roller contour** – Special shape of bending roller allows small bends without tube flattening.



### BV 20/25 – Tube bending tool

The BV 20/25 allows bending of medium size tube at the assembly site. The bending lever shows two universal studs. A bar extension can either be ordered or locally made.

#### Specifications:

Tube-O.D.: 20–25 mm  
 3 bending segments: 20, 22, 25 mm  
 Bending radius:  $r = 86,5$  mm  
 $x = 52$  mm  
 Weight: approx. 15 kg (without bar extension)

Type	Order code
BV 20/25 Tube bending tool bending device including 3 bending segments for tube O.D. 20 to 25 mm including bending lever without bar extension tube	BV20/25KPLX
<b>Spare Parts</b>	
Bending segment 20 mm	BV20/2501X
Bending segment 22 mm	BV20/2502X
Bending segment 25 mm	BV20/2503X
Fixing arm	BV20/2505X
Lever complete	BV20/2506KPLX
Bar extension tube	BV20/2510X

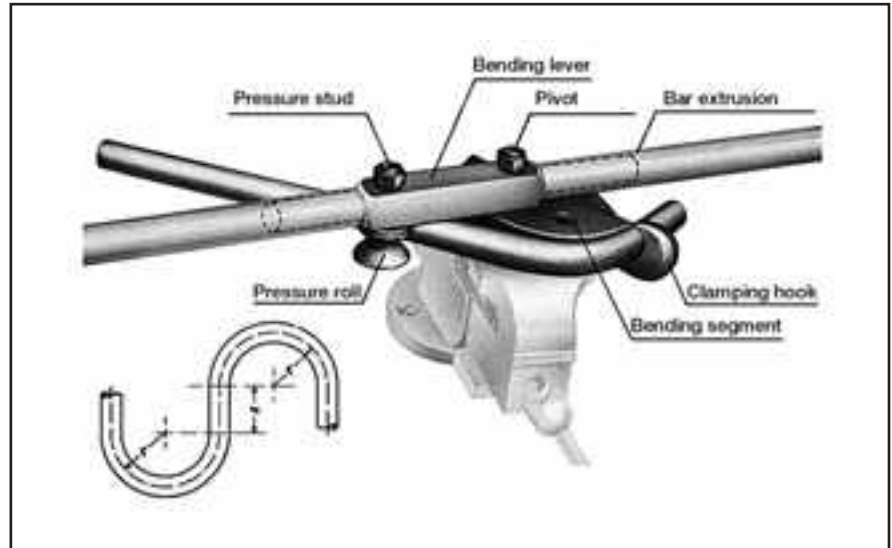

#### Features, advantages and benefits of tube-bending tool:

- Rigid design** – The solid design and the bar extension allow manual bending without heating the tube.
- Optimised bending roller contour** – Special shape of bending roller allows small bends without tube flattening.
- Shaped clamping** – Tube is not distorted by clamping.
- Small bending radii** – Compact tube bends allow for compact assemblies.
- Vice mounted** – For easy workshop use, the BV can be clamped into a vice.

# Hand-tools

## Par-Lok wrench



Par-Lok wrench

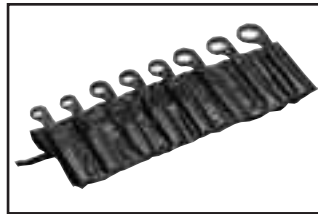

Par-Lok wrench kit

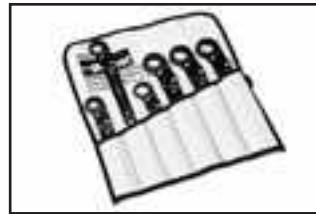

O-Lok® wrench kit



Triple-Lok® & Ferulok wrench kit

360° Snap-action ratchet wrench for hex sizes from 10 mm to 41 mm and inch sizes from 3/8" to 2 1/4" across flats. Inch sizes meet US government specifications and are listed as NSN-5120-00-474-7227.

### Easy fitting assembly

Easy access ratchet wrench speeds fittings installation in tight locations. Rugged, snap-action jaws can be opened over tube lines, locked onto fitting hex and ratcheted within 1/8 turn. Full six point contact prevents fitting distortion common with wrench slippage. Ideal for tube line installations where compact runs required multiple fittings make-up, disassembly and remakes.

### Specifications

Par-Lok wrenches are available individually or in different kit combinations. Par-Lok jaws are constructed from drop-forged, high carbon steel material with a black conversion coat finish. Par-Lok handles are made from heavy gauge steel material, heat treated and with a corrosion resistant black finish. Solid stainless steel rivets and tempered jaw springs are designed into every wrench for maximum strength.

### O-Lok® wrench kit

Six piece wrench set for use with O-Lok® body and nut sizes -4, -6, -8. Kit contains wrenches for hex sizes 5/8", 1 1/16", 3/4", 13/16", 7/8" and 15/16".

### Triple-Lok® & Ferulok wrench kit

Five piece wrench set for use with Triple-Lok® and Ferulok body and nut sizes -4, -6, -8, -10, -12. Kit contains wrenches for hex sizes 9/16", 1 1/16", 7/8", and 1" and 1 1/4".

### Features, advantages and benefits of Par-Lok wrench:

1. **360°** – No slipping and hexagon damage.
2. **Snap-mechanism** – Ideal for tube fitting assembly.
3. **Light** – Par-Lok wrenches belong in the standard toolbox of each fitting engineer.

		Inch Sizes		Metric Sizes		
Hex Size	Order code	Hex Size	Order code	Hex Size	Max. torque Nm	Order code
3/8	860062-6	1 1/8	860062-18	10 mm	35	860063-10
7/16	860062-7	1 1/4	860062-20	11 mm	37	860063-11
1/2	860062-8	1 3/8	860062-22	12 mm	42	860063-12
9/16	860062-9	1 1/2	860062-24	13 mm	45	860063-13
5/8	860062-10	1 5/8	860062-26	14 mm	57	860063-14
11/16	860062-11	1 7/8	860062-30	16 mm	88	860063-16
3/4	860062-12	2	860062-32	17 mm	107	860063-17
13/16	860062-13	2 1/4	860062-36	19 mm	125	860063-19
7/8	860062-14	Full kit of all	860062-KIT2	21 mm	149	860063-21
15/16	860062-15	eight wrenches		22 mm	178	860063-22
1	860062-16	O-Lok® kit	860062-LKIT	24 mm	209	860063-24
Full kit	860062-KIT	(six wrenches)		27 mm	100	860063-27
of all eleven sizes		Triple-Lok®/Ferulok kit	860062-XUKIT	30 mm	100	860063-30
		(five wrenches)		32 mm	170	860063-32
				36 mm	170	860063-36
				41 mm	310	860063-41
				Full kit		860063-KIT
				of all ten sizes		
				10 to 22 mm		



## Assembly tooling

---

### WZK – Tool boxes

Tools which are regularly used for tube preparation and bending are available in organized tool boxes. Two sets are available:

#### Features, advantages and benefits:

1. **Well organised** – Nothing gets dirty, damaged, lost or forgotten.
2. **Practical** – In one box you take everything to the assembly site.
3. **Rigid** – The solid metal box is suitable for daily workshop use.



Type	Content	Order code
Toolbox WZK1	BV6/18 tube bending tool	WZK1KOMPLX
Toolbox WZK2	BV6/18 tube Bending tool, AV6/42 tube saw square, Hacksaw, Flat file, Deburring tool, fixture for assembly cones VOMO and cone gauge KONU	WZK2KOMPLX



## O-ring assembly tools

### CORG O-ring installation tool for O-Lok®

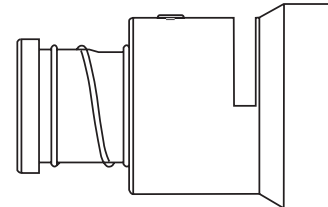

Parker's CORG Assembly Tools are designed to facilitate the installation of the O-ring into the half-dovetail groove of the O-ring face seal fitting. They are available in sizes –4 to –32 (6 mm to 50 mm/1/4" to 2" tube).

#### Ordering

Corg tool Order code	Fitting size	O-ring size
CORG-4	– 4	2-011
CORG-6	– 6	2-012
CORG-8	– 8	2-014
CORG-10	–10	2-016
CORG-12	–12	2-018
CORG-16	–16	2-021
CORG-20	–20	2-025
CORG-24	–24	2-029
CORG-32	–32	2-135

#### Operation

See chapter F "Fitting assembly" for detailed instructions

The CORG assembly tool is easy to use and can be operated in just a few steps:

1. Insert the O-ring into the slot located on the side of the tool.
2. Position the open end of the tool over the ORFS end of the fitting.
3. With the fitting end bottomed inside the tool, push the piston of the tool until the O-ring is released into the fitting groove.

### O-ring pick for O-Lok®



O-ring pick

A plastic O-ring pick to allow easy removal of O-rings without causing damage to the fitting.

#### Ordering

Type	Order code
Plastic O-ring pick device	O-RINGPICK

#### Features, advantages and benefits of O-Ring installation tools

1. **Special** – O-ring installation tools are especially designed for O-Lok® fittings with CORG groove. O-rings are not torn or damaged at assembly.
2. **Cost saving** – O-ring installation tools are easy to use and save time and cost when O-rings need to be assembled.

## Port cutting tools

### Counterbore tools and thread taps for metric ports

For manufacturing metric ports to ISO 6149 (Details see chapter D).

These tools allow correct manufacturing of metric port connections. Counterbore tools and thread taps are made of high speed tool steel.

#### Ordering counterbore tools

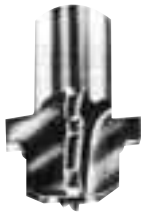

ISO 6149 Port size	Order code	
	Large Spot face <sup>1)</sup>	Small Spot face <sup>2)</sup>
M08×1	R1449A	R1449B
M10×1	R1450A	R1450B
M12×1.5	R1451A	R1451B
M14×1.5	R1452A	R1452B
M16×1.5	R1453A	R1453B
M18×1.5	R1454A	R1454B
M22×1.5	R1455A	R1455B
M27×2	R1456A	R1456B
M33×2	R1457A	R1457B
M42×2	R1458A	R1458B
M48×2	R1459A	R1459B

1) with ID-groove

2) without ID-groove

#### Ordering thread taps



Part thread ISO	Order code
M10	M10×1-6H-TAP
M12	M12×1.5-6H-TAP
M14	M14×1.5-6H-TAP
M16	M16×1.5-6H-TAP
M18	M18×1.5-6H-TAP
M22	M22×1.5-6H-TAP
M27	M27×2-6H-TAP
M33	M33×2-6H-TAP
M42	M42×2-6H-TAP
M48	M48×2-6H-TAP

### Counterbore tools and thread taps for straight SAE thread ports

For manufacturing UNF ports to SAE J 1926-1 (details see chapter D)

These tools allow correct manufacturing of UNF port connections. Counterbore tools and thread taps are made of high speed tool steel.

#### counterbore tools



Use with UNF thread size	SAE dash size	Order code
5/16-24	2	Y-34730
3/8-24	3	Y-34731
7/16-20	4	Y-34732
1/2-20	5	Y-34733
9/16-18	6	Y-34734
3/4-16	8	Y-34735
7/8-14	10	Y-34736
1 1/16-12	12	Y-34737
1 3/16-12	14	Y-34738
1 5/16-12	16	Y-34739
1 5/8-12	29	Y-34740
1 7/8-12	24	Y-34741
2 1/2-12	32	Y-34743

#### thread taps



UNF thread size	SAE dash size	Order code
5/16-24	2	5/16X24 UNF-2B
3/8-24	3	3/8X24 UNF-2B
7/16-20	4	7/16X20 UNF-2B
1/2-20	5	1/2X20 UNF-2B
9/16-18	6	9/16X18 UNF-2B
3/4-16	8	3/4X16 UNF-2B
7/8-14	10	7/8X14 UNF-2B
1 1/16-12	12	1 1/16X12 UNF-2B
1 3/16-12	14	1 3/16X12 UNF-2B
1 5/16-12	16	1 5/16X12 UNF-2B
1 5/8-12	29	1 5/8X12 UNF-2B
1 7/8-12	24	1 7/8X12 UNF-2B
2 1/2-12	32	2 1/2X12 UNF-2B

## Operation of port cutting tools

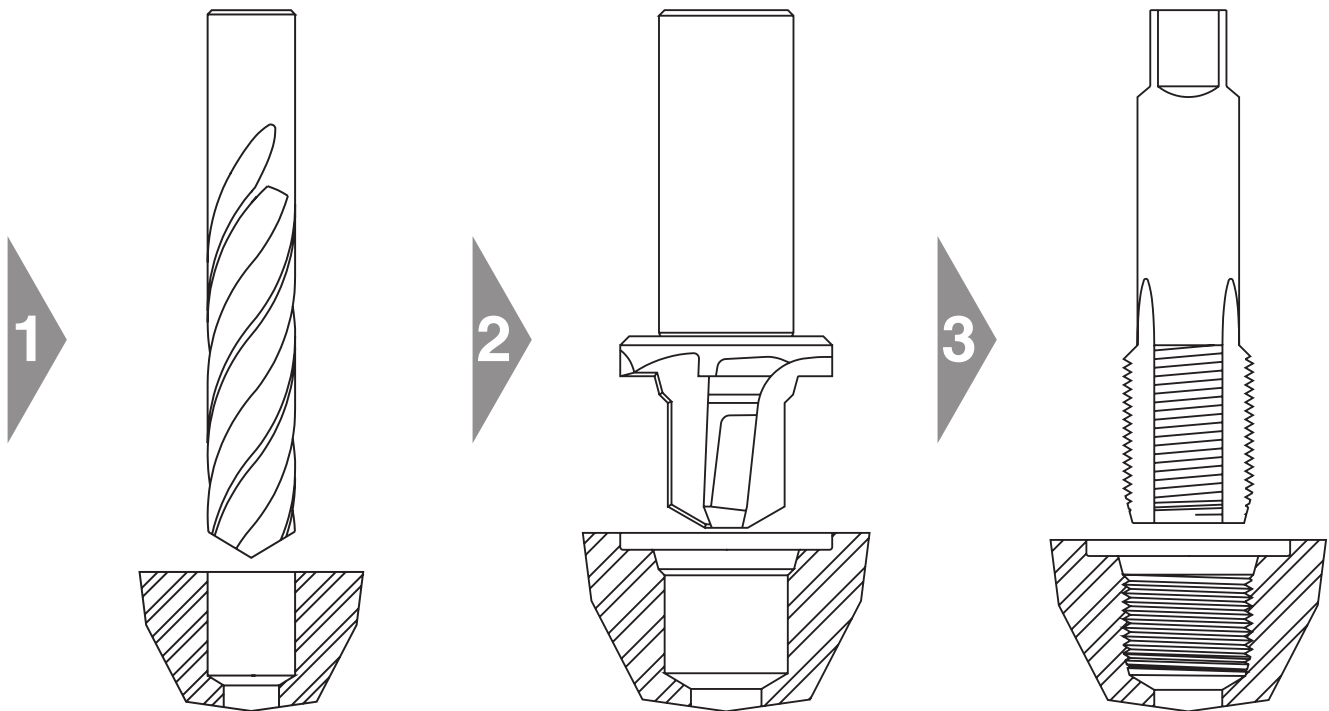

1. Pilot hole drilling

2. Port counterboring

3. Thread tapping

**Note:**

All dimensions must be according to relevant standards. See chapter D for details.

It is necessary to create a spotface surface which is flat and perpendicular to the port. Smooth finish to prevent leakage or O-ring extrusion.

Parker counterbore tools are made from high speed tool steel (HSS). Regular HSS port tapping tools are intended for workshop use and repair.

Maximum lifetime of Parker counterbores can be achieved by:

- use for cutting mild steel or aluminium only
- staying within recommended cutting speed for HSS / port material
- sufficient lubrication and cooling
- workshop use and repair only

For serial production of hydraulic ports, these Parker workshop tools are not suitable.

For production, Parker generally recommends to use hard carbide alloy.



# Thread identification

## Thread identification kit

The thread identification tools are beneficial in the assistance of the identification of international threads such as:

- European threads  
(Metric, BSPP, BSPT threads) and
- U.S. threads  
(NPT and SAE straight threads UNF)

The Thread Identification Kit is equipped with thread gauges, a set of callipers, thread profiles, and an instruction booklet.

The components of the thread ID Kit are no high precision gauges but simple instruments for workshop use.

### Ordering

Type	Order code
Thread identification kit	MIK-1

**Attention: The kit is only available in english!**



## Portboard

Portboards are suitable for thread identification of male stud connectors. The two portboards are machined with female threads for quick and easy identification by simply screwing the appropriate male port end.

- European  
(Metric, BSPP/BSPT threads)
- U.S.  
(NPT and SAE straight threads UNF)

### Ordering

Type	Order code
Portboard for NPT and SAE straight threads	Portboard A
Portboard for Metric and BSPP/BSPT threads	Portboard B



## Training equipment

### Sample case for assembly training

These practical cases are designed to support on-site assembly training. The rigid plastic boxes include sufficient nuts and rings or flare sleeves to do many hands-on assembly training. Properly cut and deburred tube-ends are also included so that functional fitting presentations, assembly machine demonstrations and proper in-depth assembly training are easy to conduct. An assortment of selected fitting bodies represent fittings like male stud ED-seal/O-Ring seal or adjustable elbows which need specific assembly procedures. For better overview and easy handling, the components are stored in individual plastic trays.

Two different sample cases are available for DIN (EO/EO2/EO2-FORM) and SAE (O-Lok®/Triple-Lok®) product training. Sample tube size is 16x2 mm, steel and stainless steel tube. These prepared tube pieces can be ordered separately for refill of the cases.

#### Specification

Case:	rigid plastic case with individual trays
Case dimension:	410 × 320 × 80 mm
Total weight:	approx. 10 kg
Tube size:	16 × 2 mm
Tube material:	steel and stainless steel

#### Ordering

Type	Order code
Sample case EO/EO2/EO2-FORM	DIN-CASE
Sample case O-Lok®/Triple-Lok®	SAE-CASE
Spare steel tube ends 10 pieces	R16X2X140VZ
Spare stainless steel tube ends 10 pieces	R16X2X14071

#### Case content

DIN CASE		SAE CASE	
Type	approx. qty	Type	approx. qty
Tube end components:		Tube end components:	
EO nuts/EO2 functional nuts FM	20	Triple-Lok®/O-Lok® nuts	20
PSR/DPR rings	50	Triple-Lok®/O-Lok® sleeves	50
EO2/EO2-FORM seal DOZ	50	Tube pieces (steel and stainless steel)	30
Tube pieces (steel and stainless steel)	30		
EO fitting bodies (steel):		Triple-Lok®/O-Lok® fitting bodies (steel):	
Tube to Tube unions	10	Tube to Tube unions	10
Male stud BSPP with ED-seal	5	Male stud BSPP with ED-seal	5
Male stud metric with O-ring	2	Male stud metric with O-ring	2
High pressure banjo	1	Male stud UNF with O-ring	2
Swivel nut elbow	1	Swivel nut elbow	2
Swivel union	1	Swivel union	2
Adjustable locknut elbow 90°/45°	1	Adjustable locknut elbow 90°/45°	2
Swivel reducer	1		
Distance piece adapter	1		



#### Please note:

Case content is continuously updated according to new product additions. Assembly tools are not included.

## Assembly tooling

---

### Features, advantages and benefits

1. **Practical** – The cases and the content have been selected from experienced trainers for use with TFDE products.
2. **Efficient** – The use of these case saves preparation time and effort.
3. **Impressive** – Customers on workshop level will be impressed on the simple but professional training equipment.
4. **Give-away samples** – Samples of the assemblies can stay at the customer. This will help to illustrate product function and demonstrate TFDE products.
5. **Dry Technology** – As both, traditional and *Dry Technology* products are included, this case is a powerful and convincing sales tool particularly on workshop level.

## Training aids

### The “Leak-free Hydraulic Connectors” pocket book

The 226th volume in the series “The Technology Library”, entitled “Leak-free Hydraulic Connectors”, has been published by “Verlag Moderne Industrie”. It represents the most comprehensive treatment of high pressure connection technology presently available in the english language. Organised according to the fitting system, not only the latest developments in connecting and assembly technology but also national and international standards as well as market trends are clearly described. Each chapter is rounded off with detailed advice on practical application.



### Specification

Title:	Leak-free Hydraulic Connectors
Contents:	Standards, operating principles and assembly for tube fittings
Author:	Bernd Schmehl, Parker Hannifin
Publisher:	Verlag Moderne Industrie, Landsberg/Lech 2002, Germany
This edition:	96 pages, 48 colour illustrations, hardback
ISBN-Nr:	ISBN 3-478-93267-X

### Ordering

The shipment will be done by the EMDC (European Marketing Distribution Center). Concerning your order please ask your Certified Distributor or the Parker Trading Subsidiary.

### Features, advantages and benefits

1. **Up-to-date knowledge** – This pocket book is ideal for those who are new to this field and who want to find their way quickly and easily into the subject. But also for users whose professional training goes back over many years, this pocket book makes for interesting reading, containing as it does information on and evaluation of the latest product solutions and assembly technology.
2. **Practical** – The publication is intended not only as a reference book but also as something that can be read when travelling. It is ideally suited as a gift.
3. **Competitor-neutral** – To a large extent the contents lean more towards international standards and less to manufacturer-specific products. This pocket book is therefore ideal for use in teaching and in-house training and further education.
4. **Problem solver** – Leakage problems occur frequently in hydraulic systems. The book helps to determine and eliminate the causes. For new projects, it can be consulted for the specification and planning of assembly work.

# Hydraulic & Offshore SUPPLIES



Offshore House, Southwick Industrial Estate, Sunderland, SR5 3TX  
hos@hos.co.uk | [www.hos.co.uk](http://www.hos.co.uk)

