

# Hydraulic & Offshore SUPPLIES

## Parker Tube Assembly Instructions

Contact our team *and*  
**Order today on:**  
**+44 (0)191 549 7335**

Offshore House, Southwick Industrial Estate, Sunderland, SR5 3TX  
hos@hos.co.uk | [www.hos.co.uk](http://www.hos.co.uk)

**Table of contents**

Safety instructions..... E4

General ..... E5

Selection of assembly process ..... E6

New EO assembly instructions for 30° final assembly ..... E8

EO Progressive ring PSR/DPR..... E9

EO-2 assembly instructions ..... E13

Checking instructions for EO assembly tools..... E17

EO2-FORM assembly instructions ..... E18

Checking instructions for EO2-FORM tools ..... E24

Weld fitting assembly ..... E25

O-Lok® assembly instructions ..... E26

Triple-Lok® assembly instructions ..... E30

Checking instructions for O-Lok® / Triple-Lok® ..... E34

Flange-Seal assembly instructions ..... E35



### Safety instructions

#### Tube fittings are safe high-pressure connections



A carefully assembled Parker tube fitting will provide a sealed joint even up to tube burst. Experience has shown that break-downs, re-tightening and leaks can be avoided by following these safety instructions. Please review your fitting procedures.

#### General safety instructions

- Uncompleted assembly will reduce the pressure and vibration capability of a fitting. It can reduce the life cycle time of a connection and leakage can occur. In extreme cases the connection can fail due to tube shear or tube crack.
- After opening a tube connection, the unit has to be re tightened with the same force used during prior assembly. Under tightening can result in leakage and can reduce the vibration resistance. Over tightening can reduce the possibilities of repeated assembly. In extreme cases the components can be destroyed.
- Parker tube fittings are intended solely for connections for fluid applications.
- Observe tube recommendations. Non-standard materials or tolerances lead to incorrect assembly.
- Do not use ball bearings, fitting pins or tapered pins, coins or washers instead of the correct Parker blanking plug as blanking parts for 24° cones.
- Tube connection and fitting body once assembled, should remain together. Fitting body is to be used once only for pre-assembly.
- Air bleeding of tube fittings which are under pressure can be dangerous.
- Tube under tension can lead to vibration failure. Tube length and bend angles are to be adhered to precisely. Fix tube lines with tube clamps.
- Tubes are not to be clamped to one another but to suitable fixed points. Plate brackets, cable connections and fixing elements are not suitable. Tubes are not mountings on which to integrate other components e.g. filters, ventilators or shut-off valves.
- Prevent oscillation, pressure surges and inherent strain by using flexible hoses for example.
- Under and over tightening of fittings during assembly reduces the capacity for withstanding pressure and vibration loads and therefore reduces the life of the tube fitting. Leaks from the tube can occur under these circumstances.
- When dismantling/transporting and re-assembling, make sure that no dirt enters the system, that the connection elements (threads, sealing surfaces) are not damaged, seals are not lost and tubes are not bent or flattened. We recommend the use of suitable protective caps.
- Disassembled fittings are to be checked for accuracy and damage and replaced if necessary.
- Do not use hand cutters or tube cutters.

- Dirt and metal contamination can lead to damage to the system and leaks.
- The operating parameters given (e.g. pressure, temperature, medium compatibility) are to be adhered to.
- Avoid flow rates > 8 m/s. The resulting forces are high and can destroy the tube lines.
- Relevant guidelines (e.g. CE, ISO, BG, TÜV, DIN) are to be observed.
- Weld fittings are manufactured out of weldable materials. No other fittings are suitable for welding.
- EO-Niromont and Parflange LUBSS are high-performance lubricants. The use of other lubricants generally leads to an increase in assembly force.
- The tools and lubricants recommended by Parker guarantee safe assembly.
- Components and tooling of different manufacturers are not necessarily compatible. For complete safety, use only Parker components.
- Fittings are to be handled with care.
- Tube lines need to be adapted tension free of the relevant connectors before assembly. An easy turning of the nut is required for the complete thread length. Otherwise leakage can occur. In extreme cases with additional vibrations tube cracks can occur.
- Vibrations have to be clamped by tube clamps. Independent vibrating units need to be separated with hoses. Otherwise tube cracks can occur.

#### Specific safety instructions for assembly

- During a progressive ring and EO-2 fitting assembly the tube has to bottom up in the stud or in the tool. Without tube bottoming the ring cannot bite sufficiently. Under load the connection can fail due to tube shear.
- Correctly flared tubes are essential for leak free performance of Triple-Lok® fittings. Special care must be taken over the flare diameter and surface finish.
- Preset bite type fittings (Progressive ring) need a final assembly according to assembly instructions.
- Stainless steel progressive ring fittings have to be preassembled in hardened tools. Otherwise the connection may fail under load due to tube shear.
- Do not assemble progressive rings and functional nuts on self-made standpipe stud ends. There is a risk of false assembly with the result of connection shear under load.
- The use of steel cutting rings for stainless steel tubes or other unauthorised tool combinations leads to incorrect assembly.

**In case of doubt please contact your Parker representative!**

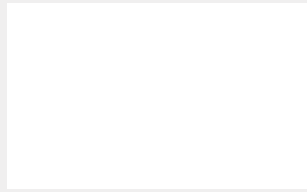
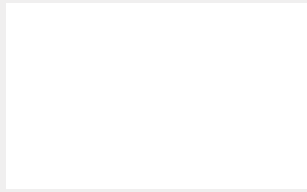
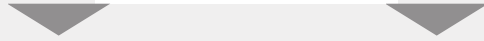

## EO progressive ring PSR/DPR

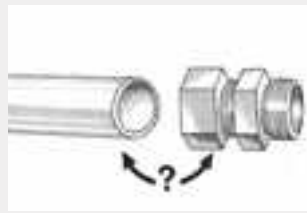

### Material combinations

- Select suitable EO progressive ring fitting

Tube material	EO-Fitting body	assembly instructions
Steel	Steel (LL=D-Ring)	
Stainless Steel	Stainless Steel	Pre-assembly by machine or hardened tool required
Copper	Brass (D-Ring)	
Plastic e.g. Polyamide	Steel, Brass, Stainless Steel	Support sleeve E required Check assembly devices for suitability
Stainless Steel	Steel	Stainless Steel DPR <b>must</b> be used Pre-assembly by machine or hardened tool required



### Tube preparation

- Cut and deburr thoroughly
- Do not assemble under tension
- Clamp onto rigid fixtures

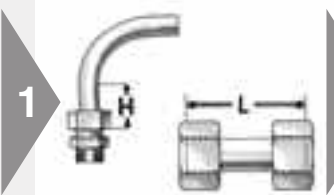

- Minimum lengths of straight tube-ends, H=2x nut length
- Use swivel union "GZ" instead of short tubes



- Cut tube squarely
- max ±1° deviation
- ⚠ Do not use pipe cutters
- EO tube-cutting tool (AV) for manual cutting



- Remove internal and external burrs
- max. chamfer 0.3 mm x 45°
- Recommendation: In-Ex Tube Deburring Tool 226



### Support sleeves VH

- Support sleeve VH for thin wall or soft metal tubes (see chart)



### Tube insert E

- Support sleeve E for plastic tubes



- Insert support sleeve like shown



- Drive VH into tube-end

- Support sleeve required
- Support sleeve required for heavily loaded lines (vibrations)

#### VH selection chart for EO Progressive Ring

For steel tubes material ST 37.4  
and for stainless steel tubes material 1.4571 and 1.4541

Wall thickness	4	5	6	8	10	12	14	15	16	18	20	22	25	28	30	35	38	42		
3																		●	●	
2.5																			●	●
2																			●	●
1.5																			●	●
1																			●	●
0.75			●																	

For soft metal tubes (e. g. copper)

Wall thickness	4	5	6	8	10	12	14	15	16	18	20	22	25	28	30	35	38	42		
3.5																			●	●
3																			●	●
2.5																			●	●
2																			●	●
1.5																			●	●
1																			●	●
0.75																			●	●
0.5																			●	●

EO progressive ring PSR/DPR

100% Pre-assembly with EOMAT/EO-KARRYMAT

- Preferred method
- Most efficient method
- ⚠ HVMB-device not suitable for 100% assembly of PSR fittings



EOMAT UNI



EOMAT ECO



EO-KARRYMAT

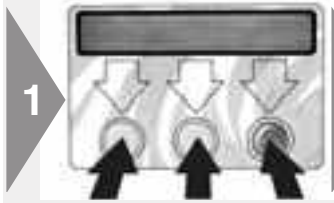

1

- EOMAT ECO/UNI and EO-KARRYMAT: Adjustment according to pressure chart on machine (PSR/DPR) Reduction of preset pressures for tube materials softer than steel and stainless steel required
- EOMAT III/A: Menu selection (PSR/DPR)
- Non-EOMAT-machines: Check suitability



Ok?

2

- Control (see checking instructions)
- Clean and lubricate assembly cone and thread regularly



3

- Insert proper tools
- Clean and lubricate assembly cones regularly
- EO-KARRYMAT: Close valve on handpump
- 2-piece backing plates for 35-L and 42-L

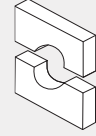

4

- Slide nut and progressive ring as shown onto the end of the tube

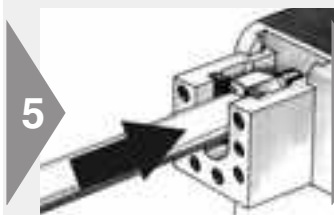

5

- Place tube with progressive ring and nut into the die
- Press tube-end firmly into the assembly cone



6

- Hold tube firmly
- EOMAT: Press and hold start button
- Use support and foot switch for long tubes
- EO-KARRYMAT: Operate handpump until assembly pressure is reached



7

- After completion of pre-assembly, remove the tube for assembly check
- EO-KARRYMAT: Open valve on handpump



8

- ⚠ Check to make sure that a visible collar covers the front of the first cutting edge
- It does not matter if the ring can be rotated on the tube-end



9

- Use distance gauge AKL for checking in mass production

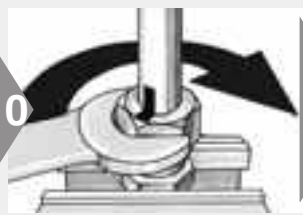

10

- Assemble fitting until wrench-tight (without spanner extension)
- ⚠ Mark position of nut

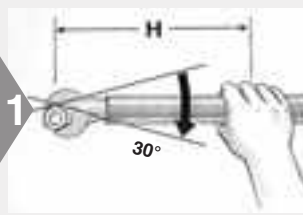

11

- ⚠ Then tighten fitting firmly by 30° (1/2 flat)
- ⚠ Recommended to use spanner extension for sizes over 20 mm O.D. (see chart)
- Assembly torques are available on request

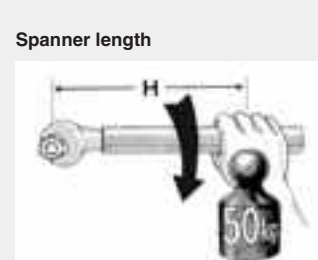

Spanner length

Size	Spanner length H [mm]
22-L	400
28-L 20-S	500
35-L 25-S	800
42-L 30-S	1000
38-S	1200

EO progressive ring PSR/DPR

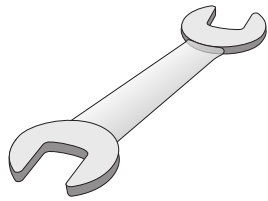

**Direct assembly**

- Simple procedure for single assemblies of small dimensions
- Not economic for series assembly
- ⚠ Tubes Ø 30, 35, 38 and 42 mm must be pre-assembled in vice
- ⚠ Stainless steel connections have to be assembled using pre-assembly tool (VOMO)
- ⚠ Properly cleaned studs ("BE") have to be assembled with pre-assembly tools



- ⚠ Lubrication of threads will reduce wear and assembly forces
- ⚠ Threads on stainless steel fittings must be lubricated
- ⚠ Use EO-NIROMONT special high-performance lubricant for stainless steel fittings

- Screw on nut until finger-tight
- ⚠ Press tube-end firmly into fitting body

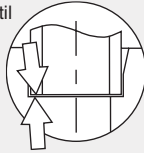

- Mark position of the nut
- Tighten the nut by 1½ turns
- ⚠ Recommended to use spanner extension for sizes over 20 mm O.D. (see chart)
- Fitting body may be used one time only

- Assembly check:**
- Loosen nut
  - ⚠ Check to make sure that a visible collar covers the front of the first cutting edge
  - It does not matter if the ring can be rotated on the tube-end

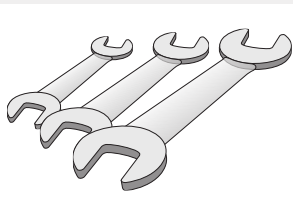

**Repeated assembly**

- Each time the tube-end has been disconnected, the fitting must be properly tightened again
- ⚠ EO progressive rings cannot be replaced, once assembled

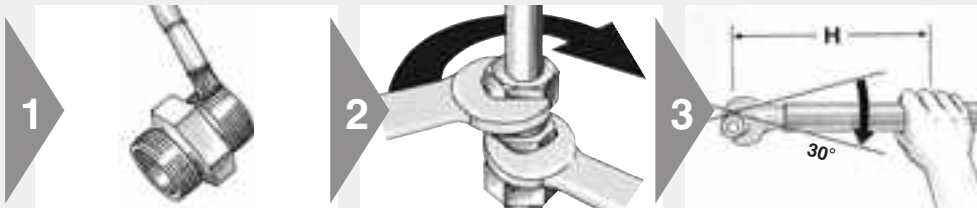

- ⚠ Threads on stainless steel fittings must be lubricated
- ⚠ Use EO-NIROMONT special high-performance lubricant for stainless steel fittings

- Each time the fitting has been loosened, re-assembly must be performed with the same torque as initial assembly
- The body must be held rigid
- ⚠ Recommended to use spanner extension for sizes over 20 mm O.D. (see chart)

- ⚠ Then tighten fitting firmly by 30° (½ flat)
- Assembly torques are available on request
- ⚠ Recommended to use spanner extension for sizes over 20 mm O.D. (see chart)

**Spanner length**

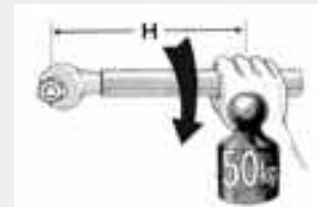

Size	Spanner length H [mm]
22-L	400
28-L 20-S	500
35-L 25-S	800
42-L 30-S	1000
38-S	1200

## EO-2 assembly instructions

Detailed assembly-instructions are included in each EO-2 product box.  
Details on Eomat setting and selection of support sleeves can be found there as well.



### Tube preparation

- Cut and deburr thoroughly
- Do not assemble under tension
- Clamp onto rigid fixtures



### Material combinations

- Select suitable FM-type

	Steel tube	Stainless Steel tube	Plastic tube
Steel fitting	FM...CF	FM...SSA	FM...CF+E
Stainless Steel fitting	—	FM...71	FM...71+E

1



- Cut tube squarely
- max ± 1° deviation
- ⚠ Do not use pipe cutters
- EO tube-cutting tool (AV)

2



- Remove internal and external burrs
- max. chamfer 0.3 mm × 45°
- Seal can be damaged by large burrs

### Tube insert E

- Tube insert E for plastic tubes



### Support sleeves VH

- Support sleeve VH for thin wall or soft metal tubes

### Use of support sleeves "VH" with EO-2 fittings

Tube O.D.	0.5	0.75	1	1.5	2	2.5	3	3.5	4
4									
6									
8									
10									
12									
14									
15			○						
16									
18									
20									
22									
25									
28									
30									
35									
38									
42					○				

Functional test required for other materials or dimensions not specified. Support sleeve VH **not required** for EO-2 and steel tube. For stainless steel tube functional test required.  
 Support sleeve VH **not required** for EO-2 and steel tube. Support sleeve VH **not required** for EO-2/71 or EO-2/SSA and stainless steel tube.  
 VH **required** for FM/71 and operating pressure above 100 bar.

1



- Support-sleeve selection: see instruction shipped with product box

2



- Drive VH into tube-end



### Replacement of sealing ring/Repeated assembly

- Sealing ring DOZ can be changed separately

### Spanner length

1



- After disassembly, sealing ring can be pulled of the tube-end
- Check for damage and replace if necessary
- Abrasion on outer rubber parts does not effect performance

2

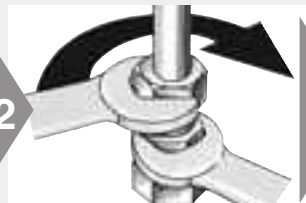

- Assemble fitting until wrench-tight (without spanner extension)

3

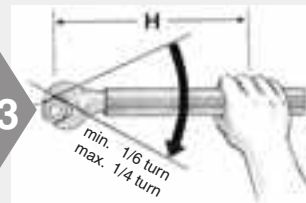

- ⚠ Then tighten fitting firmly by min 1/6 (max 1/4) turn (1 to 1 1/2 flats)
- ⚠ Recommended to use spanner extension for sizes over 20 mm O.D. (see chart)

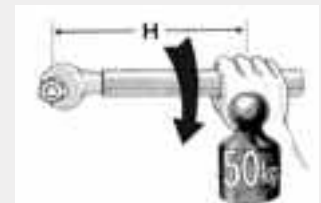

Size	Spanner length H [mm]
22-L	400
28-L 20-S	500
35-L 25-S	800
42-L 30-S	1000
38-S	1200



EO-2 assembly instructions



**EOMAT UNI**



**EOMAT ECO**



**EO-KARRYMAT**

**Assembly with EOMAT/EO-KARRYMAT**

- Preferred method
- Most efficient method
- HVM-B device is not suitable for EO-2

**1**



**2**



Ok?

**3**



**4**

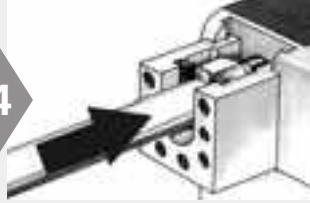

- EOMAT ECO/UNI: Adjustment according to pressure on machine (see instructions shipped with product box)
- EOMAT III/A: Menu selection
- EO-KARRYMAT: Refer to chart on machine
- Non-EOMAT-machines: check suitability

- Check according to MOK checking instructions
- Use special EO-2 MOK (silver) for Tube-OD 25 mm and larger. Advantages: easy and safe assembly

- Insert proper tools
- 2-piece tube backing plates for 35-L and 42-L
- EO-KARRYMAT: Close valve on handpump

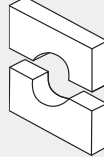

- Place tube with functional nut into the die
- Press tube-end firmly into the assembly cone
- Hold back nut for easy tube insertion

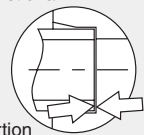

**5**



**6**



**7**

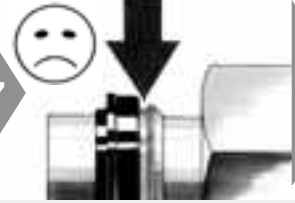

**8**



- Hold tube firmly
- EOMAT: Press and hold start button
- Use support and foot switch for long tubes
- EO-KARRYMAT: Operate handpump until assembly pressure is reached. Then open valve on handpump

**Assembly check:**

- Gap between sealing ring and retaining ring must be closed
- A little relaxation (approx. 0.2 mm) is allowed

**⚠ Gap not closed:**

- ⚠ Check all components, tube, machine, tools and pressure setting
- ⚠ Repeat assembly with increased pressure if necessary

**⚠ Threads of stainless steel fittings must be lubricated**

**⚠ Use EO-NIROMONT special high-performance lubricant for stainless steel fittings**

**9**

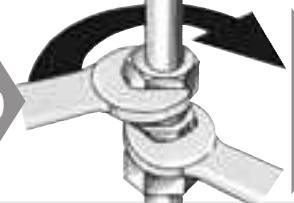

**10**

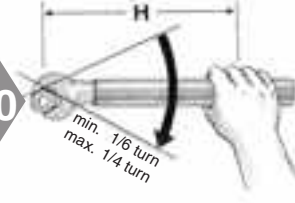

min. 1/6 turn  
max. 1/4 turn

**Spanner length**

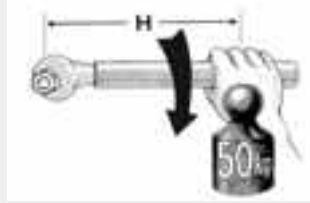

Size	Spanner length H [mm]
22-L	400
28-L 20-S	500
35-L 25-S	800
42-L 30-S	1000
38-S	1200

- Assemble fitting until wrench-tight (without spanner extension)

**⚠ Then tighten fitting firmly by min 1/6 (max. 1/4) turn (1 to 1½ flats)**

**⚠ Recommended to use spanner extension for sizes over 20 mm O.D. (see chart)**

EO-2 assembly instructions

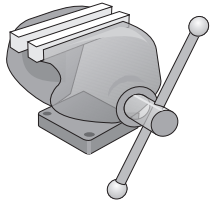

**Assembly in vice**

- Reliable method
- Only economic for assembly of small quantities



- 1
- ⚠ Threads on stainless steel fittings must be lubricated
  - ⚠ Use EO-NIROMONT special high-performance lubricant for stainless steel fittings

- 2
- Check according to VOMO checking instructions
  - Use pre-assembly tool VOMO
  - Fitting body may be used one time only and components must stay together

- 3
- Push functional nut onto tube-end
  - Advantage: Easy tube insertion, particularly large dimensions

- 4
- ⚠ Press tube-end firmly into the assembly cone
  - Screw on nut until finger-tight

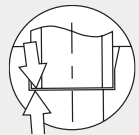

- 5
- Tighten until sharp increase of resistance (approx. 1 to 1½ turns)
  - ⚠ Recommended to use spanner extension for sizes over 20 mm O.D. (see chart)

- 6
- Assembly check:**
- Gap between sealing ring and retaining ring must be closed
  - A little relaxation (approx. 0.2 mm) is allowed

- 7
- ⚠ **Gap not closed:** Check all components including tube

- 8
- Assemble fitting until wrench-tight (without spanner extension)

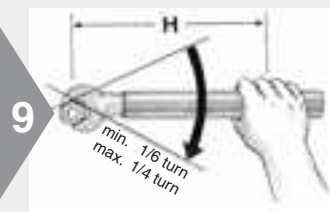

- 9
- ⚠ Then tighten fitting firmly by min 1/6 (max. 1/4) turn (1 to 1½ flats)
  - ⚠ Recommended to use spanner extension for sizes over 20 mm O.D. (see chart)

**Spanner length**

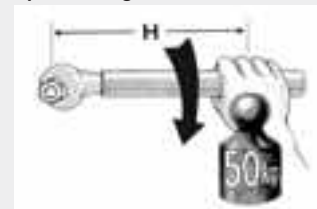

Size	Spanner length H [mm]
22-L	400
28-L 20-S	500
35-L 25-S	800
42-L 30-S	1000
38-S	1200

E

EO-2 assembly instructions

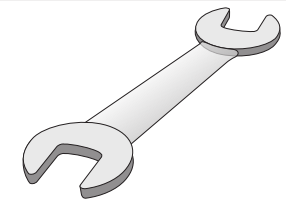

**Direct assembly**

- Simple procedure for single assemblies of small dimensions
- Not economic for series assemblies
- ⚠ Tubes Ø 30, 35, 38 and 42 mm must be pre-assembled in vice

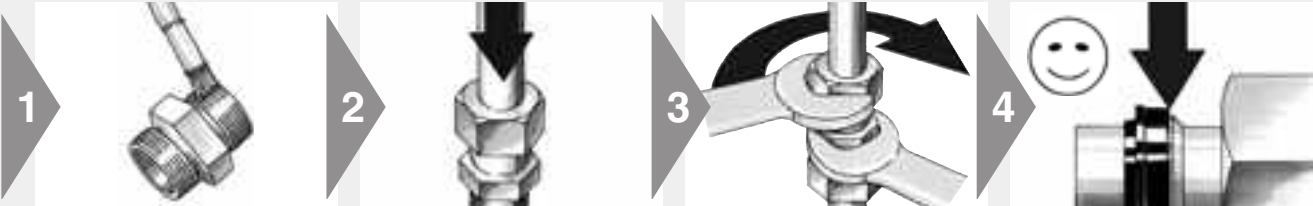

- ⚠ Threads on stainless steel fittings must be lubricated
- ⚠ EO-NIROMONT is a special high-performance lubricant for stainless steel fittings

- ⚠ Press tube-end firmly into the assembly cone
- Turn back nut for easy tube insertion



- Tighten until sharp increase of resistance (approx. 1 to 1½ turns)
- ⚠ Recommended to use spanner extension for sizes over 20 mm O.D. (see chart)

- Assembly check:**
- Gap between sealing ring and retaining ring must be closed
  - A little relaxation (approx. 0.2 mm) is allowed

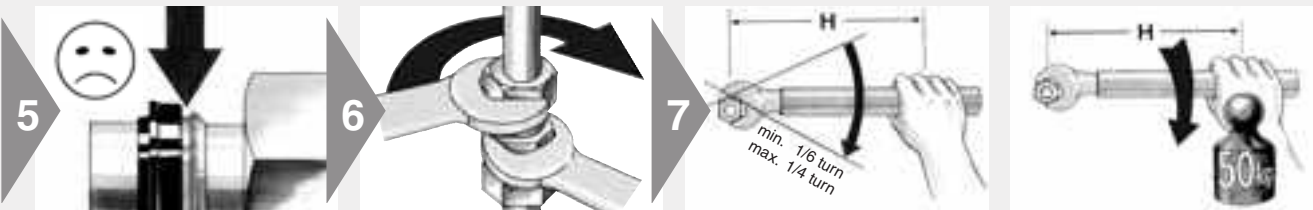

- ⚠ **Gap not closed:** Check all components including tube

- Assemble fitting until wrench-tight (without spanner extension)

- ⚠ Then tighten fitting firmly by min 1/6 (max 1/4) turn (1 to 1½ flats)
- ⚠ Recommended to use spanner extension for sizes over 20 mm O.D. (see chart)

**Spanner length**

Size	Spanner length H [mm]
22-L	400
28-L 20-S	500
35-L 25-S	800
42-L 30-S	1000
38-S	1200

## Checking instructions for EO assembly tools

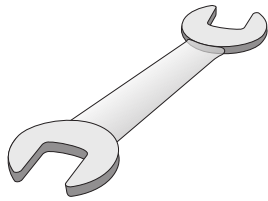

### VOMO tools for manual pre-assembly in vice MOK for use in EO assembly machines

- ⚠ Use of damaged, worn or non-suitable tooling may result in fitting failure or machine damage
- ⚠ Tools must be checked regularly, at least after 50 assemblies
- ⚠ Worn tools must be replaced ⚠ Use only genuine Parker tools
- ⚠ Tools must be kept clean and lubricated

1



- Clean cone surface for checking

2



- Visual checks:  
Cone must be free of wear, damage or cracks

3



- Check for deformation of geometry
- ⚠ Special cone gauge KONU must be used
- KONU cone gauges are precision measuring devices and must be handled accordingly

4



- Check contour:  
The rear of the gauge must protrude slightly above the top face of the cone or may be flush

5

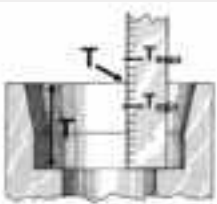

- Check insertion depth
- ⚠ Deviations from the insertion depth can cause leakages

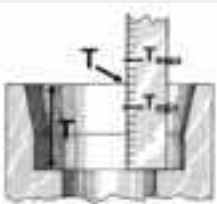

- Insertion depth T

Table: Tool for presetting tool (MOK and VOMO)

Type	T <sub>min</sub>	T <sub>max</sub>	Typ	T <sub>min</sub>	T <sub>max</sub>
6-L	6.95	7.05	6-S	6.95	7.05
8-L	6.95	7.05	8-S	6.95	7.05
10-L	6.95	7.05	10-S	7.45	7.55
12-L	6.95	7.05	12-S	7.45	7.55
15-L	6.95	7.05	14-S	7.95	8.05
18-L	7.45	7.55	16-S	8.45	8.55
22-L	7.45	7.55	20-S	10.45	10.55
28-L	7.45	7.55	25-S	11.95	12.05
35-L	10.45	10.55	30-S	13.45	13.55
42-L	10.95	11.05	38-S	15.95	16.05

E

## EO2-FORM assembly instructions



### Material combinations

- Select suitable materials
- See catalogue for exact tube specifications

### Material selection chart

Tube material	Fitting and nut material	Sealing material
Steel	Steel	Steel/NBR or Steel/FKM
Stainless Steel	Stainless Steel	Stainless/Steel FKM/NBR
Stainless Steel	Steel	Steel/NBR or Steel/FKM



### Tube preparation

- Cut and deburr thoroughly
- Cut and bend tubes exactly

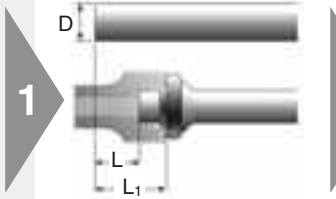

1

- Take extra length into account (see tube preparation chart)

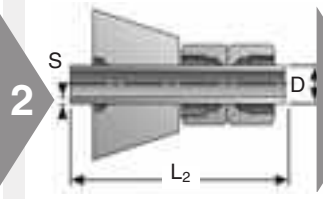

2

- Minimum lengths  $L_2$  of straight tubes (see chart)

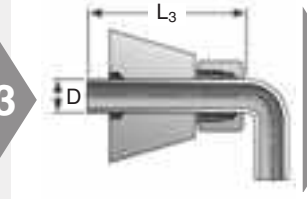

3

- Minimum lengths  $L_3$  of straight tube-ends before bend (see chart)



4

- Cut tube squarely
- max  $\pm 1^\circ$  deviation
- ⚠ Do not use pipe cutters
- EO tube-cutting tool (AV) for manual cutting



5

- Remove internal and external burrs
- max. chamfer  $0.3 \text{ mm} \times 45^\circ$
- Clean tube thoroughly



6

- Chips, dirt, internal or external burrs and paint prevent correct tube insertion
- ⚠ Dirty tubes result in worn-out or damaged tools

EO2-FORM assembly instructions

Tube preparation chart – Series L

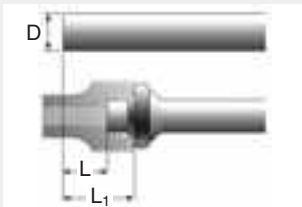

● Extra length

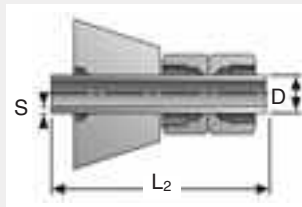

● Minimum tube length

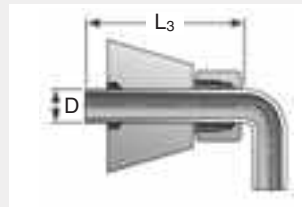

● Minimum straight length before bend



● Minimum clearance of U-shape bends

Tube-OD Series	S Wall thickness	L Steel ± 0.5	L Stainless Steel ± 0.5	L <sub>1</sub> Steel	L <sub>1</sub> Stainless Steel	L <sub>2</sub>	L <sub>3</sub>
6L	1	8.5	8.5	15.5	15.5	90	63
	1.5	6	6	13	13		
8L	1	8.5	9	15.5	16	92	65
	1.5	5.5	6	12.5	13		
	2	5		12			
10L	1	5.5	5.5	12.5	12.5	95	68
	1.5	5	6.5	12	13.5		
	2	5	6.5	12	13.5		
12L	1					95	70
	1.5	5	6	12	13		
	2	5	6	12	13		
15L	1.5	5.5	7	12.5	14	102	75
	2	5.5	7	12.5	14		
	2.5	5.5	7	12.5	14		
18L	1.5	5.5	7	13	14.5	110	80
	2	5.5	7	13	14.5		
	2.5	5.5		13			
	3	5.5		13			
22L	1.5	6	8	13.5	15.5	120	90
	2	6	8	13.5	15.5		
	2.5	6.5	8	14	15.5		
	3						
28L	1.5					140	98
	2	6.5	7.5	14	15		
	2.5	6.5	8	14	15.5		
	3						
35L	2	7	8.5	17.5	19	170	115
	3	8.5	10.5	19	21		
	4						
	5						
42L	2	7.5	9	18.5	20	190	125
	3	9	11.5	20	22.5		
	4	9		20			



**EO2-FORM assembly instructions**

**Tube preparation chart – Series S**

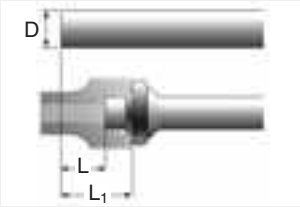

● Extra length

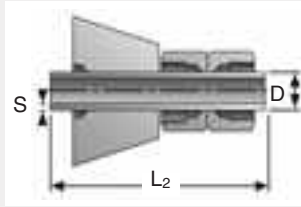

● Minimum tube length

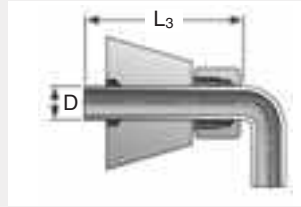

● Minimum straight length before bend



● Minimum clearance of U-shape bends

Tube-OD Series	S Wall thickness	L Steel ± 0.5	L Stainless Steel ± 0.5	L <sub>1</sub> Steel	L <sub>1</sub> Stainless Steel	L <sub>2</sub>	L <sub>3</sub>
<b>6S</b>	1	8.5	8.5	15.5	15.5	92	65
	1.5	6	6	13	13		
	2	5.5		12.5			
<b>8S</b>	1	8.5	9	15.5	16	95	68
	1.5	5.5	6	12.5	13		
	2	5		12			
<b>10S</b>	1.5	5	6.5	12.5	14	100	70
	2	5.5	6.5	13	14		
<b>12S</b>	1.5	5	6.5	12.5	14	100	72
	2	5	6.5	12.5	14		
<b>16S</b>	1.5	5.5	7	14	15.5	110	80
	2	5.5	7	14	15.5		
	2.5	5.5	7	14	15.5		
	3	5.5	7	14	15.5		
<b>20S</b>	2	7	8.5	17.5	19	135	98
	2.5	7	8.5	17.5	19		
	3	7	8.5	17.5	19		
	3.5	7		17.5			
<b>25S</b>	2	8.5	10.5	20.5	22.5	155	112
	2.5	8.5	10.5	20.5	22.5		
	3	8.5	10.5	20.5	22.5		
	4	8.5		20.5			
<b>30S</b>	3	8.5	10.5	22	24	165	122
	4	9.5	11	23	24.5		
	5	8.5		22			
<b>38S</b>	2.5		11		27	190	135
	3	11	11	27	27		
	3.5	11		27			
	4	11	12	27	28		
	5	11	13	27	29		
	6	11.5		27.5			
7	11.5		27.5				













## EO2-FORM assembly instructions

E

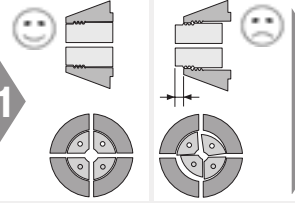

### Tube forming with EO2-FORM F3

- Reliable forming method
- Reliable process

<p><b>1</b></p> 	<p><b>2</b></p> 	<p><b>3</b></p> 	<p><b>4</b></p> 
<ul style="list-style-type: none"> <li>⚠ Change tool only when drive switched off (button OFF)</li> <li>⚠ Obey safety instructions</li> <li>⚠ Do not operate machine without tooling</li> </ul>	<ul style="list-style-type: none"> <li>● Open doors to access tools and handling devices</li> <li>● Tool handling devices are stored in middle on top</li> </ul>	<ul style="list-style-type: none"> <li>● Select suitable forming pin according to tube material, outer diameter and wall thickness</li> </ul>	<ul style="list-style-type: none"> <li>● Check forming pin for dirt, wear and damage</li> </ul>
<p><b>5</b></p> 	<p><b>6</b></p> 	<p><b>7</b></p> 	<p><b>8</b></p> 
<ul style="list-style-type: none"> <li>● Use magnetic holder to insert forming pin</li> <li>● Turn clockwise to lock bayonet fixture</li> </ul>	<ul style="list-style-type: none"> <li>● Tilt magneto holder to remove handle</li> </ul>	<ul style="list-style-type: none"> <li>● Select suitable clamping die set according to tube outer diameter</li> <li>⚠ Keep stainless tube clamping dies separate from other tube materials to prevent contact corrosion</li> </ul>	<ul style="list-style-type: none"> <li>● Check clamping dies for dirt, wear and damage</li> </ul>
<p><b>9</b></p> 	<p><b>10</b></p> 	<p><b>11</b></p> 	<p><b>12</b></p> 
<ul style="list-style-type: none"> <li>● Use pistol to handle clamping die set</li> <li>● Pull and hold handle to grab die set</li> </ul>	<ul style="list-style-type: none"> <li>● Insert clamping die set until it bottoms up (twist pistol for easy insertion)</li> <li>● Release handle to fix die set</li> <li>⚠ Never operate machine while pistol is inserted</li> </ul>	<ul style="list-style-type: none"> <li>⚠ Front surfaces must be completely flat</li> <li>⚠ Die segments must fit without gaps</li> </ul>	<ul style="list-style-type: none"> <li>● Switch on drive (button ON)</li> <li>● Each time the drive is switched on, the reset button (RESET) must be pressed first</li> <li>● The automatic tool recognition is initiated</li> <li>⚠ Clamping dies will close, reset button (RESET) must be held until it lights up</li> <li>● Lighten of reset button (RESET) indicates "ready to start"</li> </ul>



### EO2-FORM assembly instructions

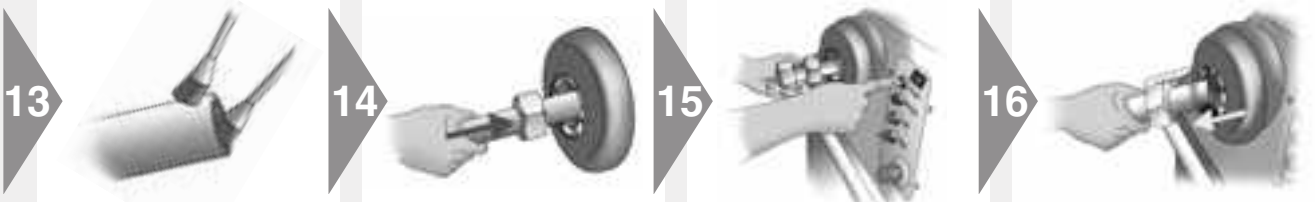

- 13
- ⚠ Make sure tube-end is free of burrs, chips and dirt
  - ⚠ Lubricate inside and outside of tube-end
  - Use EO-NIROMONT for best performance

- 14
- Insert tube-end with nut into open tool until it firmly touches the stop at the end
  - ⚠ Press tube-end firmly into the tube stop
  - ⚠ Do not turn tube-end anti-clockwise to prevent unlocking forming-pin



- 15
- Press and hold start button (Ⓢ START) until tube is clamped
  - Instead of start-button (Ⓢ START), footswitch can be used
  - ⚠ Hold tube firmly until clamping dies are closed
  - Use support for long tubes
  - ⚠ Do not reach into tool area while machine is working

- 16
- Tube can be taken out after the clamping dies are open
  - Reset button (RESET) lights up and the machine is ready for the next operation
  - Check tools regularly (approx. 50 assemblies) for dirt and wear
  - Remove tools for cleaning
  - Clean clamping dies with wire brush
  - Clean forming die using compressed air
  - Replace worn-out tooling

EO2-FORM assembly instructions

E



**Assembly check**

- Check assembly result
- ⚠ Incorrect assemblies must be scrapped

**Tube OD check**

Tube Ø-Series	min Ø [mm]	max Ø [mm]
6-L/S	9	10.2
8-L/S	11	12.2
10-L	13.2	14.2
12-L	15.2	16.2
15-L	18.5	20.2
18-L	21.5	24
22-L	26	27.7
28-L	32	33.7
35-L	39.5	42.5
42-L	46.5	49.5
10-S	13.5	15.5
12-S	15.5	17.5
16-S	19.5	21.5
20-S	24.5	27.5
25-S	30	34
30-S	35	39
38-S	43	47

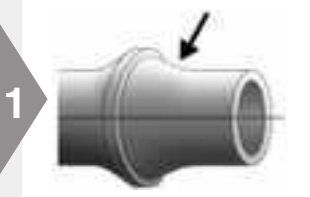

- Sealing surface (arrow) must be free of scratches and damage

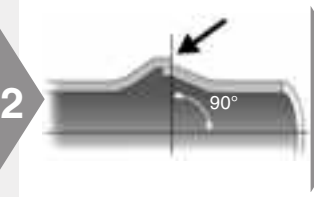

- Check contour: Contact surface for sealing ring (arrow) must be flat, at right angle to tube



- Check outer diameter Ø ... (see chart)
- ⚠ Incorrect tube-ends must be scrapped. Tools must be cleaned and checked

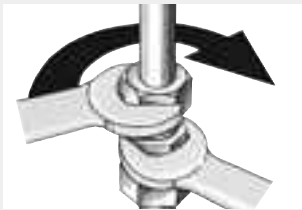

**Installation**

- ⚠ Tube must fit without tension



- Place sealing ring (DOZ) onto tube-end



- Threads of stainless steel fittings must be lubricated
- EO-NIROMONT is a special high-performance lubricant for stainless steel fittings

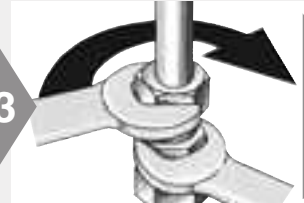

- Tube must fit without tension
- Assemble fitting until wrench-tight (without spanner extension)

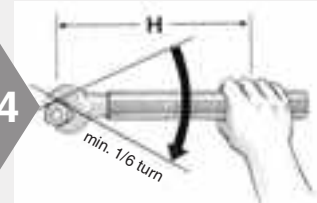

- ⚠ Then tighten fitting firmly by 1/6 turn (1 flat)
- ⚠ Recommended to use spanner extension for sizes over 20 mm O.D. (see chart)
- ⚠ Incorrect assembly reduces performance and reliability of the connection

**Spanner length**

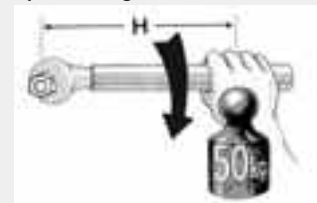

Size	Spanner length H [mm]
22-L	400
28-L 20-S	500
35-L 25-S	800
42-L 30-S	1000
38-S	1200

## Checking instructions for EO2-FORM tools



### Forming pin and clamping dies for EO2-FORM machine

- ⚠ Use of damaged, worn or non-suitable tooling may result in fitting failure and damage of machine
- ⚠ Tools must be checked regularly, at least after 50 assemblies
- ⚠ Worn tools must be replaced
- ⚠ Use only genuine Parker tools
- ⚠ Tools must always be kept clean and lubricated

1



- Clean forming pin for checking
- Do not disassemble

2



- Visual check:  
Surface must be free of wear and damage
- Use air blowgun to remove chips and dirt

3



- Clean clamping pin for checking
- Do not disassemble
- Pins must not be loose or damaged

4



- Visual check:  
Grip surface must be clean and free of wear
- Use wire-brush to remove metal particles from grip surface

## Weld fitting



### Weld fitting assembly

- EO weld nipple and weld fitting
- ⚠ Use weldable material
- ⚠ Depending on application or project specification, special requirements may apply for: Tube preparation, welding process, operator qualification, inspection of welding connection and surface finish



### Tube preparation

- Cut and deburr thoroughly
- Do not assemble under tension
- Clamp onto rigid fixtures



### Material combinations

- Select suitable tube material

Fitting material	Tube specification
Steel	Weldable Steel
Stainless Steel	Weldable Stainless Steel

1



- Cut tube squarely
- max  $\pm 1^\circ$  deviation
- ⚠ Do not use pipe cutters
- EO tube-cutting tool (AV) for manual cutting

2

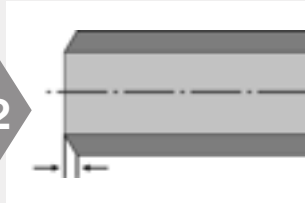

- Bevel tube-end similar to weld nipple bevel

## Assembly

3

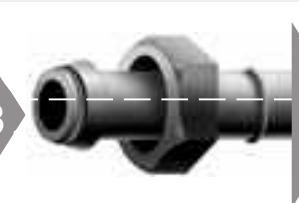

- Slide nut onto tube-end
- Weld fitting onto tube-end
- Fitting and tube must be aligned
- ⚠ Remove all elastomeric seals before welding

4



- Clean weld
- Calibrate inner diameter
- Check welding quality
- Surface protection if necessary

5

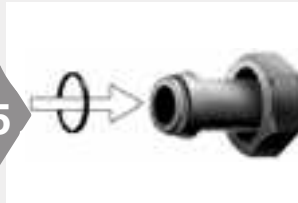

- Assemble O-ring
- Lubricate O-ring for easy assembly
- Avoid damage or twisting of O-ring

6



- ⚠ Threads of stainless steel fittings must be lubricated
- ⚠ Use EO-NIROMONT special high-performance lubricant for stainless steel fittings

7



- Screw on nut by hand until handtight

8

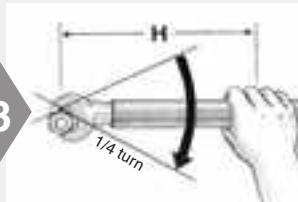

- ⚠ Then tighten fitting firmly by  $\frac{1}{4}$  turn ( $1\frac{1}{2}$  flats)

## O-Lok® assembly instructions



### Tube selection

- Select suitable tube material

Steel tube		Stainless Steel tube
Cold drawn seamless	Welded & redrawn	Cold drawn seamless
NF A 49330	NF A 49341	
ISO 3304 R	DIN 2393	NF A 49341
DIN 2391C pt 1	BS 3602/2	DIN 17458 DA/T3
BS 3602 pt1	SAE J525	ASTM A 269
SAE J524		1.4571 on request



### Tube preparation

- Cut and deburr thoroughly

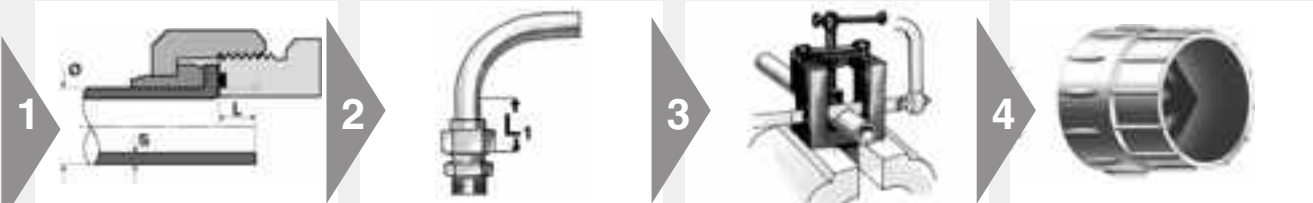

- Calculate tube length before cutting
- Add extra length "L"

- Minimum length of straight tube-ends (see chart below)

- Cut tube squarely
- max. ±1° deviation
- ⚠ Do not use pipe cutters
- Use tube-cutting tool AV for manual cutting

- Remove internal and external burrs
- max. chamfer 0.3 mm × 45°
- Recommendation: In-Ex Tube Deburring Tool 226
- ⚠ Proper deburring and cleaning of inner diameter essential for sealing surface quality

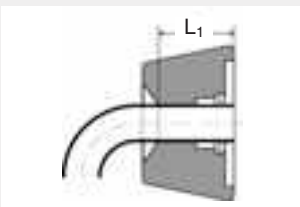

Metric tube [mm]		Minimum straight length to start to bend L1 [mm]	Extra length ~ L [mm] for Tube Wall thickness							
Tube Ø	Wall thickness		1	1.5	2	2.5	3	3.5	4	5
6	1.0 – 1.5	40	4.5	5.5						
8	1.0 – 2.0	40	5.0	5.0						
10	1.0 – 2.0	40	2.5	4.0	3.5					
12	1.0 – 3.0	50	3.5	4.5	4.5	4.0	4.0			
14	1.5 – 2.0	50			5.0					
15	1.0 – 2.0	50		4.5	5.0					
16	1.5 – 3.0	50		3.0	3.0	3.0	2.5			
18	1.5 – 2.0	50		6.0	5.5					
20	2.0 – 3.5	50			3.5	4.0	4.0	3.5		
22	1.5 – 2.5	50			6.5	7.0				
25	2.0 – 4.0	50				4.0	4.5		4.0	
28	1.5 – 3.0	50			6.0	7.0				
30	2.0 – 4.0	50			5.0				5.0	
32	2.0 – 4.0	50							3.5	
35	2.0 – 3.0	50							7.0	
38	2.0 – 5.0	50							5.0	4.5
50	3.0	50							4.0	

Inch tube [inch]		Minimum straight length to start to bend L1 [mm]	Extra length ~ L [inch] Tube Wall thickness										
Tube Ø	Wall thickness		0.028"	0.035"	0.049"	0.065"	0.083"	0.095"	0.109"	0.120"	0.134"	0.156"	0.188"
1/4"	0.020 – 0.065	40	4.5	5.0	4.0								
3/8"	0.020 – 0.095	40		3.5	3.5	4.0	4.0	4.0					
1/2"	0.028 – 0.095	50		3.5	3.5	3.5	3.5	3.5					
5/8"	0.035 – 0.120	50			4.0	4.0	3.0	4.5	4.0	4.5			
3/4"	0.035 – 0.156	50			4.0	4.0	3.0	2.5	3.5	4.0	4.5		
1"	0.035 – 0.188	50				3.5	3.5	2.5	4.5	4.5	5.0		
1.1/4"	0.049 – 0.188	50					4.0	3.0	3.0	3.0	4.0	4.5	4.5
1.1/2"	0.049 – 0.220	50					4.5	4.5	5.0	5.0	5.0	6.0	5.5
2"	0.083 – 0.120	50						4.0	4.0		5.0		

## O-Lok® assembly instructions



Parflange® 1050



Parflange® 1025

### O-Lok® machine flanging and assembly

- Preferred method
- Most efficient method
- Parflange® recommended

1



- Parflange® machines:
- Select flaring pin according to tube dimensions
  - Use special "SS" pin for stainless steel tube
  - Pin must be clean and free of wear, damage and metal particles
  - Keep flaring pin clean and lubricate regularly

2



- Select flanging dies according to tube dimensions
- Use special "SS" dies for stainless steel tube to avoid contact corrosion
- Grip surface must be clean and free of wear
- Use only genuine Parker tooling for flanging O-Lok®

3



- Load pin into machine
- Ensure lubricating system is filled with oil (LUBSS)

4

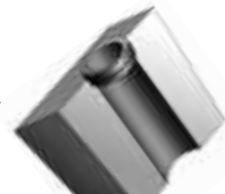

- Place sleeve in lower die half
- Locate upper die half onto lower half

5



- Place the dies in the die housing
- 1050: Close safety cover

6



- Slide nut onto tube before flanging!
- Open threads towards machine

7



- ⚠ Press tube firmly into the die against the tube stop

8



- Pull down the handle to clamp the tube in the dies (1025)
- 1040/1050 die clamping automatic in cycle
- Press button to start flanging cycle
- ⚠ Keep hands clear off the working area

9



- Parflange® 1025: Unclamp the dies
- Remove tube from machine
- Use die separator to free tube
- Parflange® 1040/1050: Die unclamping is automatic

E

## O-Lok® assembly instructions

### Checking of flange



- Clean flange for inspection
- ⚠ Check sealing surface for cracks, burrs, scratches and pitting



- Dimensional check of the flare
- Flare O.D. should not exceed outside sleeve diameter
- Flare O.D. should not be less than smaller diameter of front of sleeve
- When in doubt, measure



Tube O.D.		Ø D	
mm	In.	min. [mm]	max. [mm]
6	1/4"	12.10	12.75
8		14.85	15.75
10	3/8"	14.85	15.75
12	1/2"	18.00	18.90
14		22.20	23.45
15		22.20	23.45
16	5/8"	22.20	23.45
18		26.60	27.85
20	3/4"	26.60	27.85
22		32.95	34.20
25	1"	32.95	34.20
28		39.35	40.55
30		39.35	40.55
32	1.1/4"	39.35	40.55
35		47.25	48.50
38	1.1/2"	47.25	48.50
50	2"	58.90	60.60

### Installation in fitting



- Lubricate O-ring
- ⚠ Steel fittings: No thread lubrication
- Stainless steel fittings: Lubrication required
- EO-NIROMONT is a special high-performance lubricant for stainless steel fittings

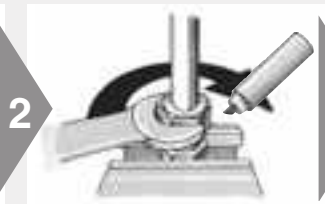

- Thread nut onto body
- Tighten to full metal contact
- Mark body and nut as quality check

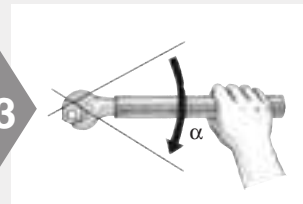

- Tighten to recommended torque level
- Recommended: Tighten with spanner the number of flats indicated  $\alpha$
- 1 flat = 60°

#### Tightening recommendation

Metric tube [mm]	Inch tube [inch]	SAE dash size	SAE thread	Assembly torque Nm -0% + 10%		α flats from wrench resistance method*	
				Steel	Stainless Steel	Tube	Swivel nut
6	1/4"	-4	9/16-18	25	32	1/4 - 1/2	1/2 - 3/4
8	5/16"	-6	1.1/16-16	40	50	1/4 - 1/2	1/2 - 3/4
10	3/8"	-6	1.1/16-16	40	50	1/4 - 1/2	1/2 - 3/4
12	1/2"	-8	1.3/16-16	65	70	1/4 - 1/2	1/2 - 3/4
14		-10	1-14	80	100	1/4 - 1/2	1/2 - 3/4
15		-10	1-14	80	100	1/4 - 1/2	1/2 - 3/4
16	5/8"	-10	1-14	80	100	1/4 - 1/2	1/2 - 3/4
18		-12	1.3/16-12	115	145	1/4 - 1/2	1/3 - 1/2
20	3/4"	-12	1.3/16-12	115	145	1/4 - 1/2	1/3 - 1/2
22		-16	1.7/16-12	150	190	1/4 - 1/2	1/3 - 1/2
25	1"	-16	1.7/16-12	150	190	1/4 - 1/2	1/3 - 1/2
28		-20	1.11/16-12	190	235	1/4 - 1/2	1/3 - 1/2
30		-20	1.11/16-12	190	235	1/4 - 1/2	1/3 - 1/2
32	1.1/4"	-20	1.11/16-12	190	235	1/4 - 1/2	1/3 - 1/2
35		-24	2-12	245	305	1/4 - 1/2	1/3 - 1/2
38	1.1/2"	-24	2-12	245	305	1/4 - 1/2	1/3 - 1/2
50	2"	-32	2.1/2-12	-	490	-	-

\* "Flats From Wrench Resistance" Method for steel and stainless steel

O-Lok® assembly instructions

E



O-Lok®: Replacement of O-ring

- Parker CORG assembly tool should be used for O-Lok® fitting with captive O-ring groove (O-Lok®)



1

- Insert the O-ring into the slot located on the side of the tool



2

- Position the open end of the tool over the tube-end of the fitting



3

- Push the piston of the tool until the O-ring is released into the fitting groove

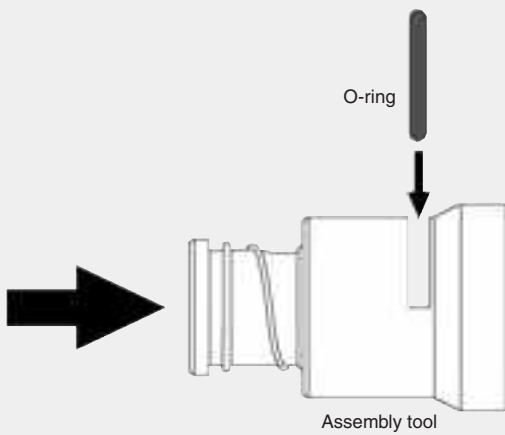

- Function of Parker CORG assembly tool



## Triple-Lok® assembly instructions



### Tube selection

- Select suitable tube material

Steel tube		Stainless steel tube
Cold drawn seamless	Welded & redrawn	Cold drawn seamless
NF A 49330	NF A 49341	
ISO 3304 R	DIN 2393	NF A 49341
DIN 2391C pt 1	BS 3602/2	DIN 17458 DA/T3
BS 3602 pt1	SAE J525	ASTM A 269
SAE J524		



### Tube preparation

- Cut and deburr thoroughly

**1**

- Calculate tube length before cutting
- Add extra length "L"

**2**

- Minimum length L<sub>1</sub> of straight tube-ends (see chart below)

**3**

- Cut tube squarely
- max. ±1° deviation
- ⚠ Do not use pipe cutters
- Use tube cutting tool AV for manual cutting

**4**

- Remove internal and external burrs
- max. chamfer 0.3 mm × 45°
- Recommendation: In-Ex Tube Deburring Tool 226
- ⚠ Proper deburring and cleaning of inner diameter essential for sealing surface quality

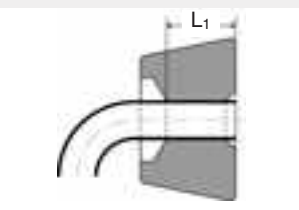

### Tube preparation chart

Metric tube [mm]		Inch tube [inch]		Extra length ~ L [mm]	Minimum straight length to start to bend L <sub>1</sub> [mm]	Flare Ø Ø D [mm]
Tube Ø	Wall thickness	Tube Ø	Wall thickness			
6	1.0 – 1.5	1/4"	0.020 – 0.065	2	40	8.6 – 9.7
8	1.0 – 1.5	5/16"	0.020 – 0.065	2	40	10.2 – 11.3
10	1.0 – 1.5	3/8"	0.020 – 0.065	2	42	11.7 – 12.7
12	1.0 – 2.5	1/2"	0.028 – 0.083	2.5	43	16.0 – 17.3
14	1.5 – 2.0			2.5	52	19.3 – 20.2
15	1.0 – 2.5			2.5	52	19.3 – 20.2
16	1.5 – 2.5	5/8"	0.035 – 0.095	2.5	52	19.3 – 20.2
18	1.5 – 3.0			3	56	23.4 – 24.7
20	2.0 – 3.0	3/4"	0.035 – 0.109	3	57	23.4 – 24.7
22	1.5 – 3.0			3	58	26.5 – 27.8
25	2.0 – 3.0	1"	0.035 – 0.120	3	58	29.7 – 31.0
28	1.5 – 3.0			4	65	37.6 – 38.9
30	2.0 – 3.0			4	65	37.6 – 38.9
32	2.0 – 3.0	1.1/4"	0.049 – 0.120	4	65	27.6 – 38.9
35	2.0 – 3.0			4	70	43.2 – 45.3
38	2.0 – 4.0	1.1/2"	0.049 – 0.120	4	70	43.2 – 45.3
42*	2.0 – 3.0			5	80	52.0 – 54.8
50	2.0 – 3.5	2	0.058 – 0.134	5		59.2 – 61.2

- \* Tube OD 42 mm:
- 1015: not suitable
- KarryFlare: special flaring pin KARRYFLARE/FPIN42 required

## Triple-Lok® assembly instructions

### 37° Flaring Parflange®-Process

- Preferred method
- Most efficient method
- Parflange® recommended



Parflange® 1050



Parflange® 1025

1



- Select flaring pin according to tube dimensions
- Use special "SS" pin for stainless steel tube
- Pin must be clean and free of wear and damage
- Load tooling into machine
- Keep flaring pin clean and lubricate regularly

2



- Select flaring dies according to tube dimensions
- Use special "SS" dies for stainless steel tube
- Grip surface must be clean and free of wear
- Use only genuine Parker tooling for flaring Triple-Lok® Plus

3



- Load tooling into machine
- Keep sliding surfaces clean and lubricated
- 1050: Close safety cover

4



- Slide nut and sleeve as shown onto the tube-end

5



- ⚠ Press tube firmly into the die against the tube stop
- Parflange® 1025: Operate clamping lever
- Parflange® 1040/1050: Automatic tube clamping

6



- Hold tube firmly
- Press start button
- ⚠ Keep hands clear off the working area

7



- Parflange® 1025: Unclamp the dies
- Parflange® 1040/1050: Die unclamping is automatic
- Remove tube from machine
- Use die separator to free tube

E

## Triple-Lok® assembly instructions

### 37° Flaring with EOMAT/KarryFlare

- Preferred method
- Most efficient method
- Parflange® recommended



- Flaring pin is integrated in flaring block
- Pin must be clean and free of wear and damage
- Keep flaring pin clean
- KarryFlare: Flaring pin for 42 mm tube O.D. must be fitted with flat face on top



- Select flaring dies according to tube O.D.
- Grip surface must be clean and free of wear
- Use only genuine Parker tooling for flaring Triple-Lok®
- Keep sliding surfaces clean and lubricated



- Slide nut and sleeve as shown onto the tube-end



- Lubricate tube-end inside
- Lubricant LUBSS recommended



- ⚠ Press tube firmly into the die against the tube stop
- KarryFlare: Close valve on handpump
- KarryFlare: Keep lid closed



- EOMAT UNI: Adjustment according to pressure on machine
- EOMAT III/A: Menu selection (FLARE)
- KarryFlare: Refer to chart on machine
- Non-EOMAT-machines: check suitability



- Hold tube firmly
- EOMAT: Press and hold start button
- KarryFlare: Operate handpump until assembly pressure is reached
- ⚠ Keep hands clear off the working area
- ⚠ KarryFlare: Do not exceed max pressure 400 bar



- KarryFlare: Open valve on handpump
- Remove tube from machine
- Use die separator to free tube

## Triple-Lok® assembly instructions

### Checking the flare



- Clean flare for inspection
- ⚠ Check sealing surface for cracks, burrs, scratches and pitting



- Dimensional check of the flare
- Flare O.D. should not exceed outside sleeve diameter
- Flare O.D. should not be less than smaller diameter of front of sleeve
- When in doubt, measure

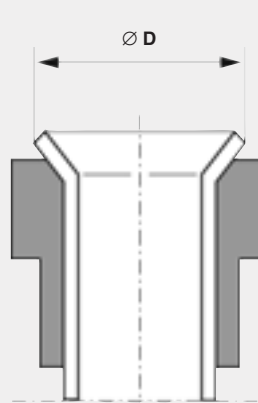

Tube O.D.		Ø D	
mm	inch	Min.	Max.
6	1/4"	8.6	9.7
8	5/16"	10.2	10.3
10	3/8"	11.7	12.7
12	1/2"	16.0	17.3
14		19.3	20.2
15		19.3	20.2
16	5/8"	19.3	20.2
18		23.4	24.7
20	3/4"	23.4	24.7
22	7/8"	26.5	27.8
25	1"	29.7	31.0
28		37.6	38.9
30		37.6	38.9
32	1.1/4"	37.6	38.9
35		43.2	45.3
38	1.1/2"	43.2	45.3
42		52.0	54.8

### Installation



- Steel fittings: No lubrication
- ⚠ Stainless steel fittings: Lubrication required
- Use EO-NIROMONT special high-performance lubricant for stainless steel fittings



- Thread nut onto body
- Tighten to full metal contact (finger tight)
- Mark body and nut as quality check
- Tighten with spanner the number of flats indicated

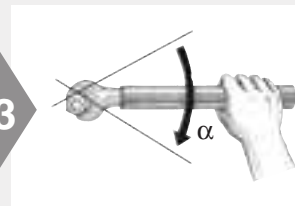

- Use spanner extension for larger fittings (28 mm)

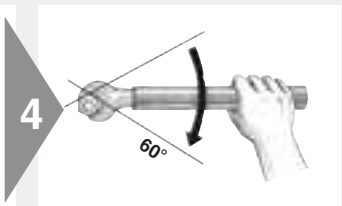

- 1 flat = 60°

#### Tightening recommendation

Metric Tube [mm]	Inch tube [inch]	SAE thread	α flats from finger tight method*		Assembly torque Nm -0% + 10%	
			tube	Swivel nut	Steel	Stainless steel
6	1/4"	7/16-20	2"	2"	15	30
8	5/16"	1/2-20	2"	2"	20	40
10	3/8"	9/16-18	1.1/2"	1.1/4"	30	60
12	1/2"	3/4-16	1.1/2"	1"	60	115
14		7/8-14	1.1/2"	1"	75	145
15		7/8-14	1.1/2"	1"	75	145
16	5/8"	7/8-14	1.1/2"	1"	75	145
18		1.1/16-12	1.1/4"	1"	110	180
20	3/4"	1.1/16-12	1.1/4"	1"	110	180
22	7/8"	1.3/16-12	1"	1"	135	225
25	1"	1.5/16-12	1"	1"	175	255
28		1.5/8-12	1"	1"	260	295
30		1.5/8-12	1"	1"	260	295
32	1.1/4"	1.5/8-12	1"	1"	260	295
35		1.7/8-12	1"	1"	340	345
38	1.1/2"	1.7/8-12	1"	1"	340	345
42		2.1/4-12	1"	1"	380	400

\* "Flats From Finger Tight" Method for steel and stainless steel

### Checking instructions for O-Lok®/Triple-Lok® tools



#### Tools for Parflange® machines

- ⚠ Use of damaged, worn or non-suitable tooling may result in fitting failure and damage of machine
- ⚠ Tools must be checked regularly, at least after 50 assemblies
- ⚠ Worn tools must be replaced
- ⚠ Use only genuine Parker tools
- ⚠ Tools must always be kept clean and lubricated

1



- Clean pin for checking

2



- Visual check:  
Surface must be free of wear and damage

3



- Clean die halves for checking
- ⚠ Do not disassemble
- Fixing pins must not be loose or damaged

4



- Visual check:  
Grip surface must be clean and free of wear
- Use wire-brush to remove metal particles from grip surface



#### Adjustment of Parflange® dies

- Parflange® dies can be adjusted to correct deviations of flare diameter
- ⚠ Re-adjustment of dies will not help if general machine setting is incorrect or components are damaged (worn tube-stop, loose screw connections)

1



- To reduce the flare diameter, turn the screws anti-clockwise
- ⚠ Re-adjust both screws simultaneously

2



- To increase the flare diameter, turn the screws clockwise
- ⚠ Re-adjust both screws simultaneously
- 1 click  $\triangle$  approx. 0.05 mm  $\varnothing$

3



- Adjust the screws in small stages
- Then check flare diameter
- ⚠ Lock screws to prevent misadjustment

## Flange-Seal assembly instructions

E



### Tube selection

- Select suitable tube material

Steel tube	
Cold drawn seamless	Welded & drawn
NF A 49330	NF A 49341
ISO 3304 R	DIN 2393
DIN 2391C pt 1	BS 3602/2
BS 3602 pt1	SAE J525
SAE J524	



### Tube preparation

- Cut and deburr thoroughly

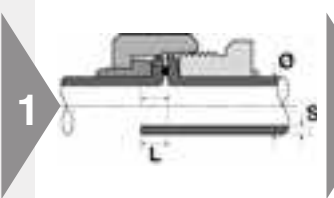

1

- Calculate tube length before cutting
- Add extra length "L" (see chart below)



2

- Minimum length of straight tube-ends (see chart below)



3

- Cut tube squarely
- max.  $\pm 1^\circ$  deviation
- ⚠ Do not use pipe cutters
- Use tube-cutting tool AV for manual cutting



4

- Remove internal and external burrs
- max. chamfer  $0.3 \text{ mm} \times 45^\circ$
- Recommendation: In-Ex Tube Deburring Tool 226
- ⚠ Proper deburring and cleaning of inner diameter essential for sealing surface quality

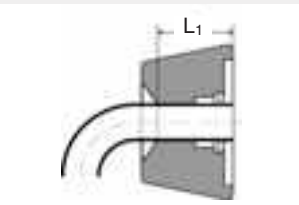

Metric tube [mm]		Minimum straight length to start to bend L1 [mm]	Extra length – L [mm] for tube wall thickness								
Tube $\varnothing$	Wall thickness		1	1.5	2	2.5	3	3.5	4	5	
6	1.0 – 1.5	50	4.5	5.5							
8	1.0 – 2.0	50	5.0	5.0							
10	1.0 – 2.0	50	2.5	4.0	3.5						
12	1.0 – 2.5	50	3.5	4.5	4.5	4.0					
16	1.5 – 3.0	50		3.0	3.0	3.0	2.5				
20	2.0 – 3.5	65			3.5	4.0	4.0	3.5			

Inch tube [inch]		Minimum straight length to start to bend L1 [mm]	Extra length – L [mm] for tube wall thickness [inch]										
Tube $\varnothing$	Wall thickness		0.028"	0.035"	0.049"	0.065"	0.083"	0.095"	0.109"	0.120"	0.134"	0.156"	0.188"
1/4"	0.020 – 0.065	40	4.5	5.0	4.0								
3/8"	0.020 – 0.095	40		3.5	3.5	4.0	4.0	4.0					
1/2"	0.028 – 0.095	50		3.5	3.5	3.5	3.5	3.5					
5/8"	0.035 – 0.120	50			4.0	4.0	3.0	4.5	4.0	4.5			
3/4"	0.035 – 0.134	50			4.0	4.0	3.0	2.5	3.5	4.0	4.5		

## Flange-Seal assembly instructions



Parflange® 1050



Parflange® 1025

### Flange-Seal machine flanging and assembly

- Preferred method
- Most efficient method
- Parflange® recommended

1



Parflange® machines:

- Select flaring pin according to tube dimensions
- Use standard O-Lok® Plus pins
- Pin must be clean and free of wear, damage and metal particles
- Keep flaring pin clean and lubricate regularly

2



- Select flanging dies according to tube dimensions
- Use special Flange-Seal dies
- Grip surface must be clean and free of wear
- Use only genuine Parker tooling for flanging

⚠ Note limitation on wall thickness for tube-tube connections

3



- Load pin into machine
- Ensure lubricating system is filled with oil (LUBSS)
- 1050: Close safety cover

4



- Place threaded sleeve (LHP) in lower die half
- Locate upper die half onto lower half

5



- Place the dies in the die housing

6



⚠ Press tube firmly into the die against the tube stop

7



- Pull down the handle to clamp the tube in the dies (1025)
  - 1050 die clamping automatic in cycle
  - Press button to start flanging cycle
- ⚠ Keep hands clear off the working area

## Flange-Seal assembly instructions

**8**



- Parflange® 1025:  
Unclamp the dies
- Remove tube from machine
- Use die separator to free tube
- Parflange® 1040/1050:  
Die unclamping is automatic

**9**



- Clean flange for inspection
- ⚠ Check sealing surface for cracks, burrs, scratches and pitting

**10**

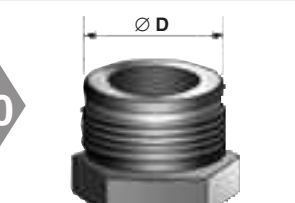

- Dimensional check of the flare

Tube O.D.		Ø D	
mm	inch	min. [mm]	max. [mm]
6	1/4"	12.10	12.75
8		14.85	15.75
10	3/8"	14.85	15.75
12	1/2"	18.00	18.90
16	5/8"	22.20	23.45
20	3/4"	26.60	27.85

**11**

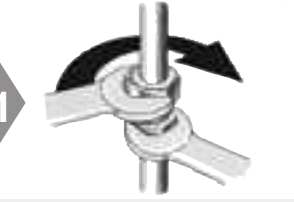

- Place seal into loose tube nut
- Tighten to full metal contact
- Tighten to recommended torque level

**Tightening recommendation**

Metric tube [mm]	Inch tube [inch]	SAE dash size	SAE thread UN/UNF-2A	Assembly torque Nm -0% + 10% Steel
6	1/4"	-4	9/16-18	25
8	5/16"	-6	1.1/16-16	40
10	3/8"	-6	1.1/16-16	40
12	1/2"	-8	1.3/16-16	65
16	5/8"	-10	1-14	80
20	3/4"	-12	1.3/16-12	115

**System component guide – Flange-Seal system**  
Metric tubes

Tube O.D. (mm)	Con. dash size	Flange-Seal fitting	Seal element	Die tool*	Pin tool
6	4	LHMPS6	4PLS	M4018006XxxxMLHP	B3018006XxxxM
8	6	LHMPS8	6PLS	M4018008XxxxMLHP	B3018008XxxxM
10	6	LHMPS10	6PLS	M4018010XxxxMLHP	B3018010XxxxM
12	8	LHMPS12	8PLS	M4018012XxxxMLHP	B3018012XxxxM
16	10	LHMPS16	10PLS	M4018016XxxxMLHP	B3018016XxxxM
20	12	LHMPS20	12PLS	M4018020XxxxMLHP	B3018020XxxxM

\*xxx: Insert tube wall thickness according to tooling list  
 \*Example 1: Metric tube tooling for 8x1.5 mm  
 Die: M4018008x1.5MLHP  
 Pin: B3018008x1.5M

**System component guide – Flange-Seal system**  
Inch tubes

Tube O.D. (mm)	Con. dash size	Flange-Seal fitting	Seal element	Die tool*	Pin tool
1/4"	4	4LHP-S	4PLS	M4004Xxxx180LHP	B4004Xxxx180
3/8"	6	6LHP-S	6PLS	M4006Xxxx180LHP	B4006Xxxx180
1/2"	8	8LHPS	8PLS	M4008Xxxx180LHP	B4008Xxxx180
5/8"	10	10LHP-S	10PLS	M4010Xxxx180LHP	B4010Xxxx180
3/4"	12	12LHP-S	12PLS	M4012Xxxx180LHP	B4012Xxxx180

\*xxx: Insert tube wall thickness according to tooling list  
 \*Example 2: Inch tube tooling for 1/2x0.083"  
 Die: M4008x083180LHP  
 Pin: B4008x083180





# Hydraulic & Offshore SUPPLIES



Offshore House, Southwick Industrial Estate, Sunderland, SR5 3TX  
hos@hos.co.uk | [www.hos.co.uk](http://www.hos.co.uk)

